

CADDY[®]

Electrical and Low Voltage/ Datacomm Fasteners

2011

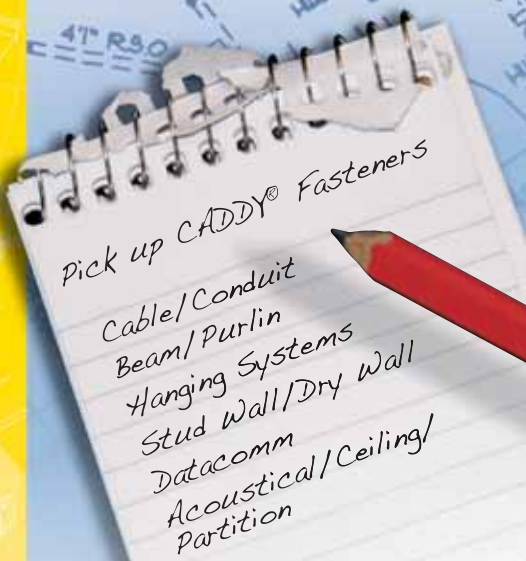

Pick up CADDY[®] Fasteners

- Cable/Conduit
- Beam/Purlin
- Hanging Systems
- Stud Wall/Dry Wall
- Datacomm
- Acoustical/Ceiling/
Partition

















ERICO[®]



Innovation and Quality – The Cornerstones of Our Business

For more than 100 years, ERICO has built its reputation by developing and marketing high-quality, innovative products. As a trusted industry leader, our products and services are recognized for providing labor- and cost-saving solutions for customers throughout the world. As ERICO continues to maintain a strong focus on developing innovative, leading-edge products, we also support green building initiatives by producing products that incorporate recycled content to use less raw materials and minimize waste. It is our goal to continue to create high-quality, state-of-the-art products, while also providing the unparalleled service our customers have come to expect.

Table of Contents

	New & Featured Products.....	5-10
	Applications	11-34
	Code Compliance.....	35-52
	Cable/Conduit.....	53-94
	Beam/Purlin.....	95-116
	Strut	117-132
	Hangers/Hanging Systems	133-148
	Stud Wall.....	149-174
	Drywall	175-180
	Datacomm/ITS.....	181-214
	Acoustical/Ceiling/Partitions	215-234
	Miscellaneous	235-240
	Reference Information.....	241-244
	The CADDY® Fastener Story.....	245-248
	Index.....	249-257

As part of our ongoing commitment to innovation and quality, ERICO® is dedicated to minimizing the impact we place on our environment. This catalog is printed on paper made with post-consumer recycled fiber, which is one example of our pledge for environmental preservation. By printing on this recycled paper, we have saved:

- Over 44,000 lbs. of wood: A total of 152 trees that supply enough oxygen for 76 people annually.
- More than 55,000 gal. of water: Enough water to take 3,236 eight-minute showers.
- Over 100 min. BTUs of energy: Enough energy to power an average American household for 426 days.
- More than 13,000 lbs. of emissions: Carbon sequestered by 161 tree seedlings grown for 10 years.
- More than 7,000 lbs. of solid waste: A total of 246 thirty-two gallon garbage cans of waste

Superior Corrosion Resistance

ERICO is revolutionizing corrosion protection with CADDY® ARMOUR. This innovative corrosion protection system for steel parts is UL® Recognized and RoHS compliant. Testing conducted by independent testing facilities and ERICO has proven CADDY ARMOUR to be the most advanced, self-healing coating available, providing the highest level of corrosion resistance on the market.

Excellent Coat Quality

CADDY ARMOUR provides an extremely consistent and even coating. This aesthetically pleasing appearance is particularly important for installations in highly visible areas, such as open ceilings.

Utilizing a state-of-the-art, computer-controlled process, the coating is applied consistently to each part, enabling up to 10 times greater corrosion resistance performance. Corrosion resistance is proven through the ASTM® B117/ DIN 50021 salt spray and GM 9540P Accelerated Cyclic Corrosion tests.



HOT PRODUCTS



CADDY® ROD LOCK

CADDY® ROD LOCK is an innovative threaded rod mounting system from ERICO that provides a quick and economical solution for installing electrical and mechanical systems supported by threaded rod. The system includes the CADDY ROD LOCK beam clamp, channel nut and an anchor screw.

With its breakthrough "push-install" design, CADDY ROD LOCK simplifies the installation of threaded rod. Simply push the threaded rod through the mounting hole and it instantly locks into position. The system can even be used on threaded rod with slightly damaged threads or minor burrs, helping to save time by minimizing the amount of deburring that is usually required prior to installation.

SEE PAGES 96, 119, 139

Featured Products



SN Series Nut

This innovative new solution for supporting loads on threaded rod is extremely easy to install and can be positioned instantly on threaded rod at any location, helping to significantly reduce installation time. Simply open the nut and insert it on the threaded rod where needed. Then twist it to close and tighten with a wrench. It's that easy!

SEE PAGE 139



TSRBS1625

The TSRBS1625 Telescoping Box Support is ideal for supporting and positioning 4" square and 4-11/16" electrical boxes and mud rings. A unique, open design allows boxes to be positioned anywhere inside the opening of the TSRBS1625. For added convenience, boxes can be installed off-site and then are fully adjustable to fit varying stud spaces on-site without needing to modify the box location.

SEE PAGE 159



Box Eliminator Conduit Support

The first product of its kind, the Box Eliminator Conduit Support is designed to maintain the integrity of high-performance cable and help prevent damage, such as kinking, that can occur when an electrical box is used. This support attaches to the MP1S single gang or the MP2S double gang plate mounting bracket.

SEE PAGE 207



CADDY® GLIDER

The CADDY® GLIDER Electrical Box Attachment is designed to simplify the installation of electrical boxes and allows for final adjustment on the jobsite. The CADDY GLIDER easily attaches to any electrical box and is versatile enough to be used in a variety of applications, especially prefab. Once attached, the installer can easily adjust the box location and the width of the TSGB between the studs.

SEE PAGE 162



Featured Products

All CADDY® PYRAMID products are designed with a wide variety of high-quality, user-friendly features:

- **Versatile:** CADDY PYRAMID products offer superior load capacity and dramatically reduce installation time by replacing slow, heavy and labor-intensive methods to support pipe, conduit, duct, cable tray and equipment.
- **Durable:** CADDY PYRAMID has passed a variety of rigorous tests, including an extreme temperature test. Unique materials and finishes offer superior corrosion protection.
- **Roof Friendly:** CADDY PYRAMID products are specifically designed for rooftop applications. Unlike wood blocks, CADDY PYRAMID is designed to help protect roof membranes. The CADDY PYRAMID EZ Series is made from EPDM, the same material as many roof membranes. The base design of the CADDY PYRAMID ST Series and CADDY PYRAMID RL Series helps distribute loads evenly to avoid stress concentration on membranes. The original CADDY PYRAMID polyethylene closed-cell foam is one of the most roof-friendly materials on the market today.

SEE PAGES 83 - 93



CADDY® PYRAMID ST Series

A strut-based support utilizing an engineered thermoplastic base with a UV stabilizer. The CADDY PYRAMID ST Series offers excellent load distribution with high load ratings.

CADDY® PYRAMID RL Series

Polymeric-roller based support helps ensure long-lasting performance and smooth roller actions. The CADDY PYRAMID RL Series provides superior durability for rooftop environments.



CADDY® PYRAMID EZ Series

EPDM rubber-based and height-adjustable. Requires no tools or fittings, making installations easier than ever.

Featured Products



CADDY® CAT LINKS

CADDY® CAT LINKS is the newest, most innovative J-Hook support solution from ERICO, the company that brought you the original CADDY® CABLECAT patented J-Hook.

CADDY CAT LINKS offers the largest family of J-Hook sizes on the market. The full range provides a bending radius that meets TIASM standards for Cat 6a and easily accommodates Cat 7, large diameter optical fiber, innerduct and coaxial cable.

See for yourself how the versatile CADDY CAT LINKS can simplify your installations while saving time and labor.

SEE PAGE 182 - 183



TIA is a registered service mark of the Telecommunications Industry Association.

Featured Products



Electrical Box Bracket

The TEB23 bracket offers an easy-to-install method for mounting boxes or plaster rings in low-voltage applications. Two far-side supports provide increased stability after installation. The TEB23 features round and octagon-shaped keyholes to quickly and easily identify the location of the electrical boxes.

SEE PAGE 150



CER4

This innovative cable support maintains the 1-1/4" spacing from the face of the stud that is required by the NEC.® Suitable for both non-metallic sheathed cables and MC/AC cables, the CER4, is the next generation of the popular CJ6 cable support.

SEE PAGE 168



FMSBC1

The new FMSBC1 Fixture Mount Stabilizer Clip effectively secures and levels ceiling tiles that have lifted during the installation of trim rings and signage. This unique clip requires no tools for installation and is ideal for use with square or hex-shaped electrical boxes. The FMSBC1 helps eliminate bulges in ceiling tiles for a professional-looking installation.

SEE PAGE 223



CADDY® LINIAN Clip

The CADDY® LINIAN Clip, is a time-saving alternative for installing fire-resistant cables on brickwork, concrete, masonry, wood studs and wood beams. The CADDY LINIAN Clip easily fixes cable by simply drilling a hole, positioning the clip around the cable, compressing the clip's legs and pushing the clip into the hole. After the hole is drilled, no tools are needed for installation, which reduces installation time by up to 70% over conventional installation methods.

SEE PAGE 206

Featured Products



Standoff Decking Fasteners

ERICO now offers a variety of time-saving CADDY® solutions for supporting conduit and electrical boxes under metal decking. These easy-to-install clips and fasteners meet the requirements of Section 300.4(E), which states that cables and raceways must be installed at least 1-1/2" (38 mm) under the roof decking to prevent potential damage from nails or screws.*

The TDH decking hanger and the CPNAM decking fasteners are paired with the M Series or the CD Series conduit clips for single conduit runs. The versatile SBT18 multiple conduit mounting plate is also used to suspend up to three runs of conduit.

The B18 combination conduit/electrical box hanger is designed for use with electrical box and conduit supports to deliver NEC® and CEC® compliance. With one riveted assembly, the box and conduit are properly supported.

SEE PAGE 74 - 75

Note: Rigid metal conduit and Intermediate metal conduit are exempt from compliance.

CEC is a registered trademark of Canadian Standards Association International. NEC is a registered trademark of, and National Electrical Code (NEC) standard is a copyright of the National Fire Protection Association.



Applications



Applications

CONDUIT/CABLE

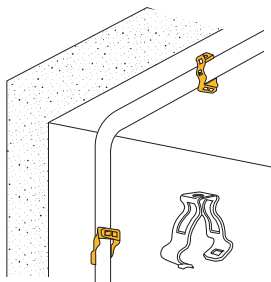

SEE PAGES 54

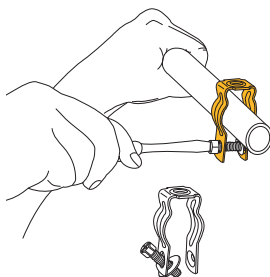

SEE PAGE 56

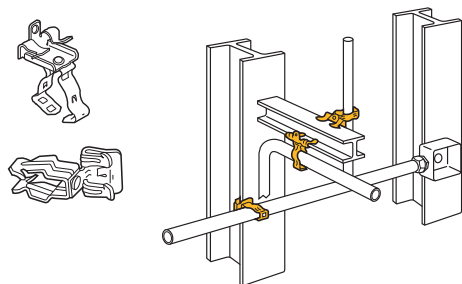

SEE PAGES 57, 58, 59

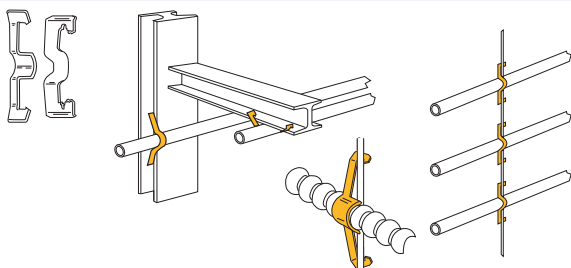

SEE PAGE 60, 61

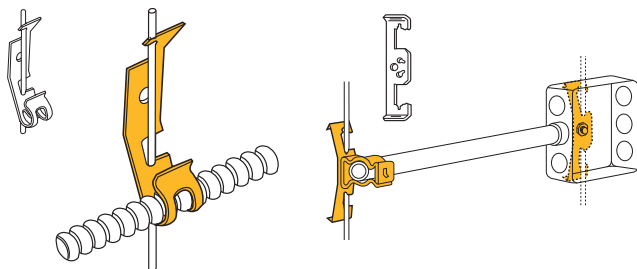

SEE PAGE 62

SEE PAGE 63



Applications

CONDUIT/CABLE

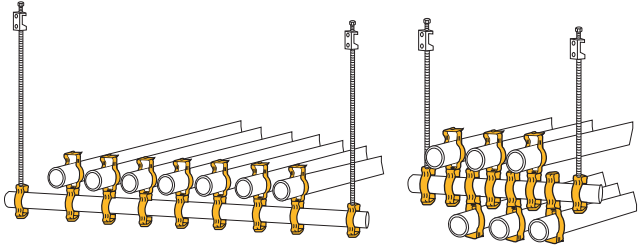

SEE PAGE 64

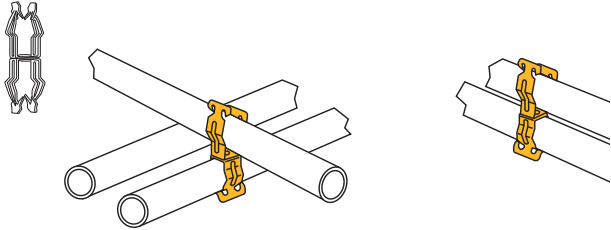

SEE PAGE 64

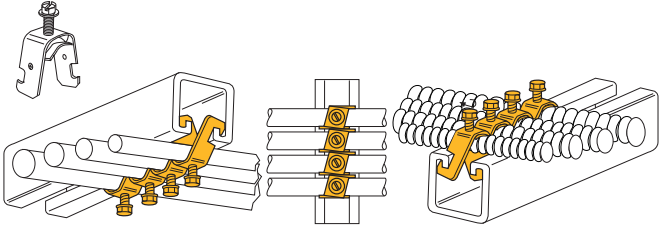

SEE PAGE 65

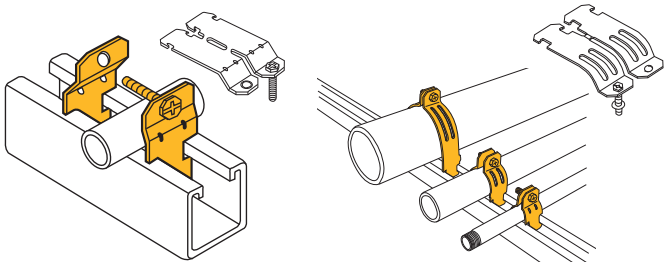

SEE PAGE 66

SEE PAGE 67

Applications

CONDUIT/CABLE

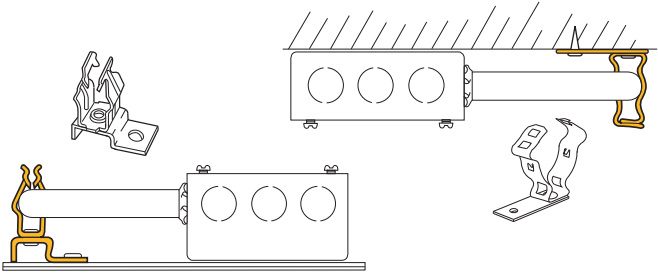

SEE PAGE 93

SEE PAGE 93

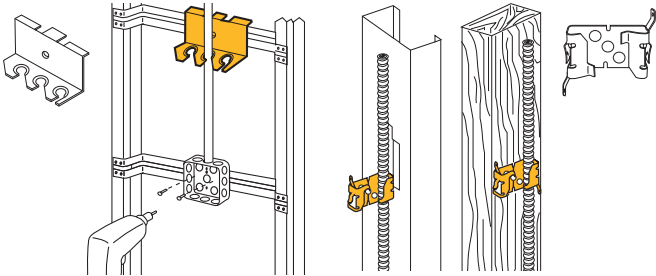

SEE PAGE 164

SEE PAGES 68, 69

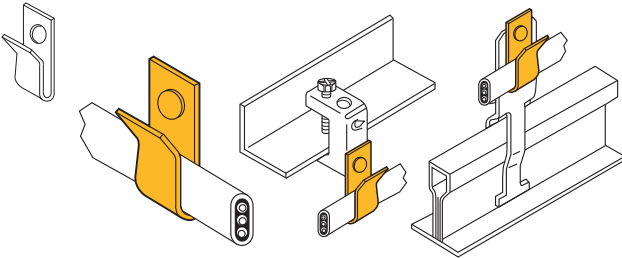

SEE PAGES 70, 71

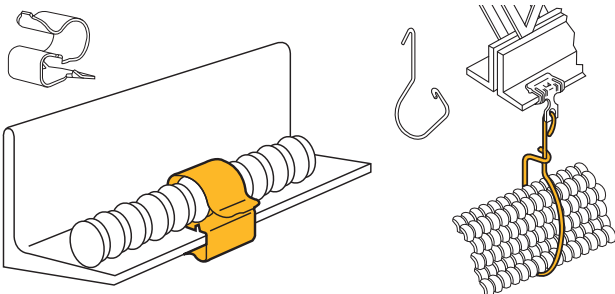

SEE PAGE 76

SEE PAGE 77



Applications

CONDUIT/CABLE

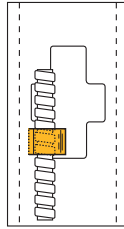
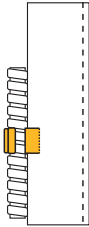

SEE PAGE 77

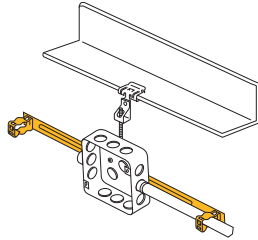
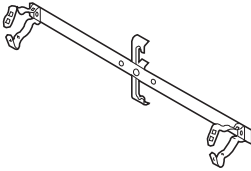

SEE PAGES 72, 73

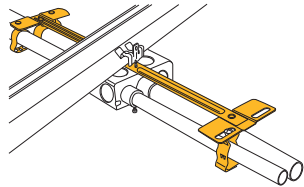
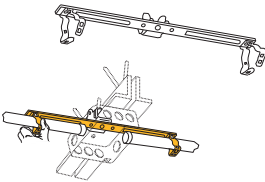

SEE PAGES 72, 73

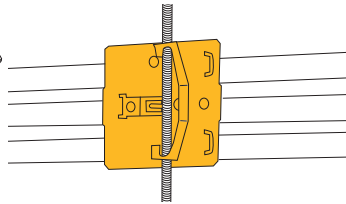
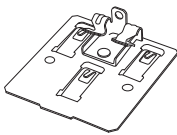

SEE PAGES 81

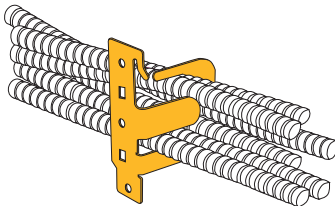

SEE PAGE 78, 79

Applications

CONDUIT/CABLE

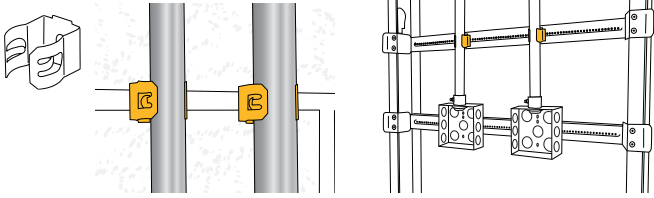

SEE PAGES 55

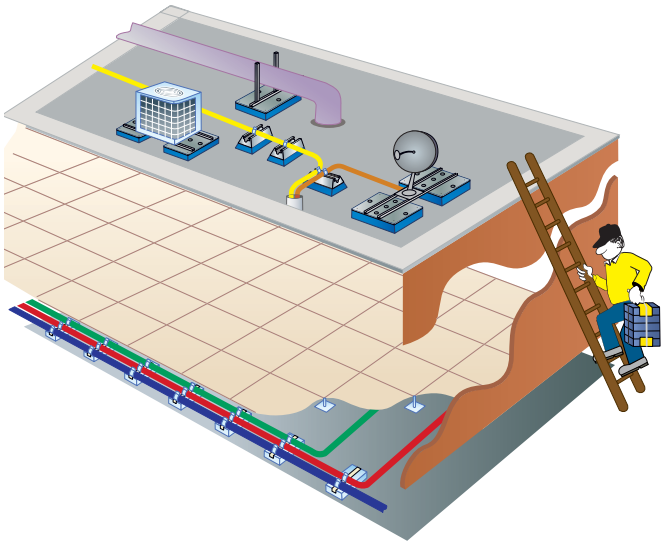
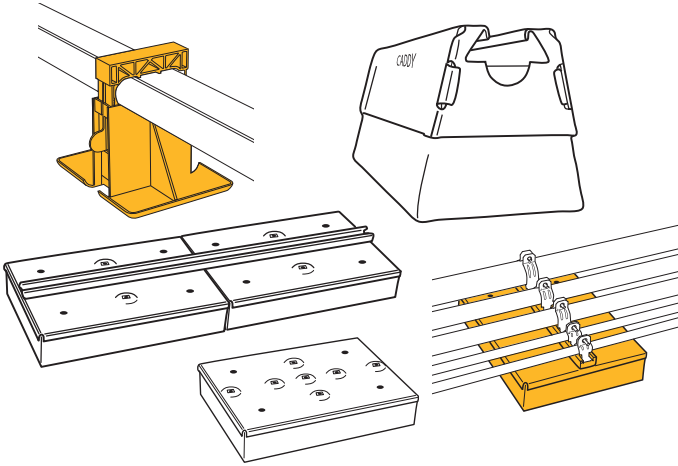

SEE PAGES 83-92



Applications

BEAM/PURLIN

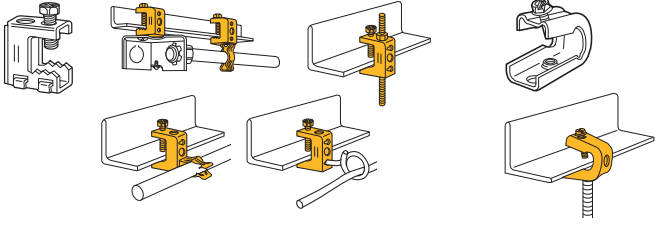

SEE PAGES 98, 99

SEE PAGES 100

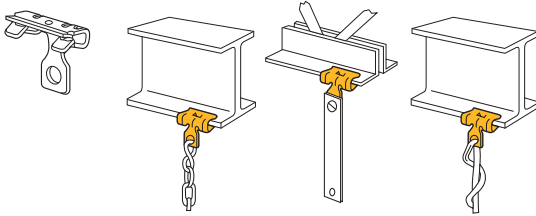

SEE PAGES 97, 101

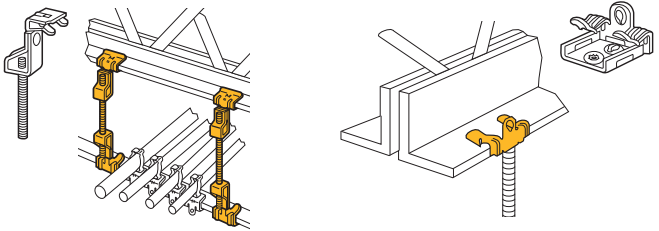

SEE PAGES 101, 136

SEE PAGE 102

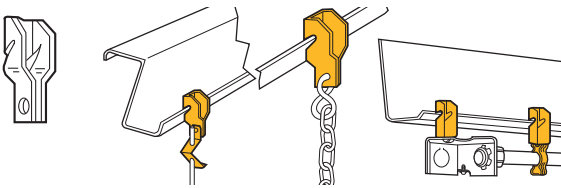

SEE PAGE 105

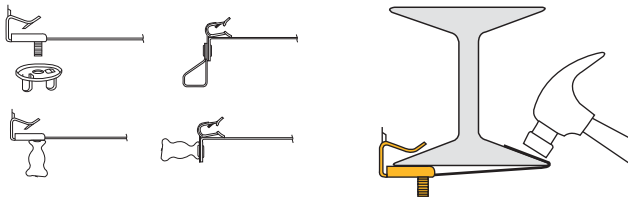

SEE PAGES 107

Applications

BEAM/PURLIN

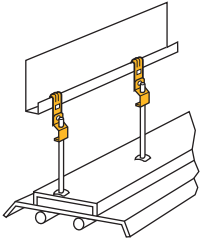
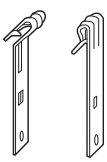

SEE PAGES 103, 104

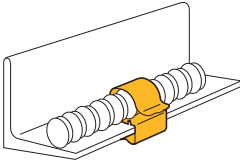

SEE PAGE 76

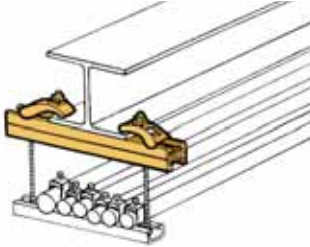
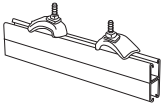
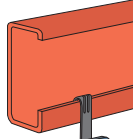

SEE PAGE 128

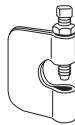
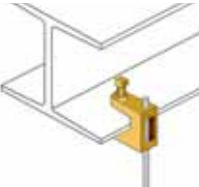
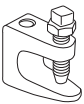

SEE PAGE 110

SEE PAGE 114

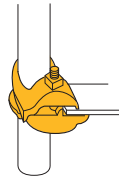
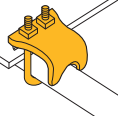

SEE PAGE 115



Applications

STRUT

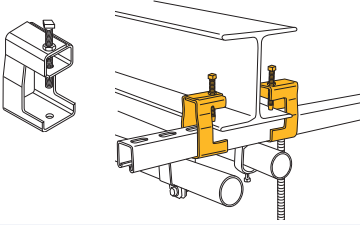

SEE PAGE 127

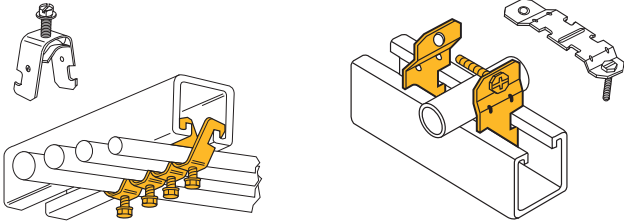

SEE PAGE 125

SEE PAGE 126

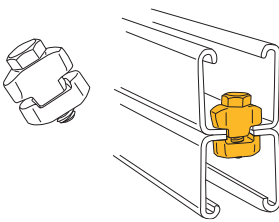

SEE PAGE 123

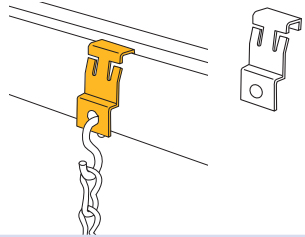

SEE PAGE 131

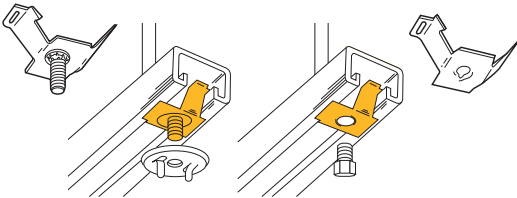

SEE PAGE 120

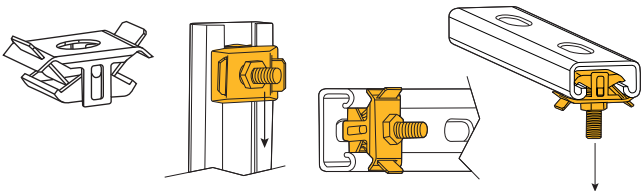

SEE PAGE 122

Applications

HANGERS/HANGING SYSTEMS

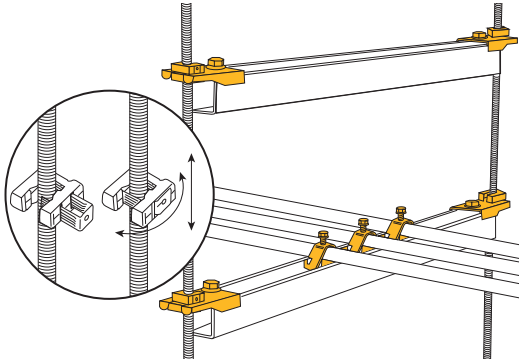

SEE PAGE 140

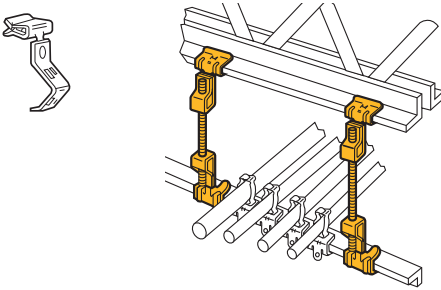

SEE PAGES 101, 136

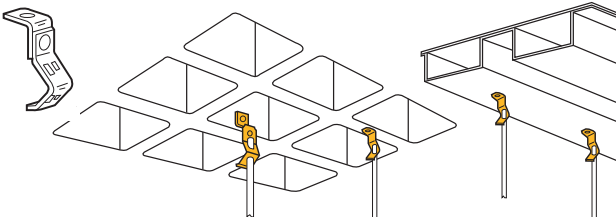

SEE PAGE 134

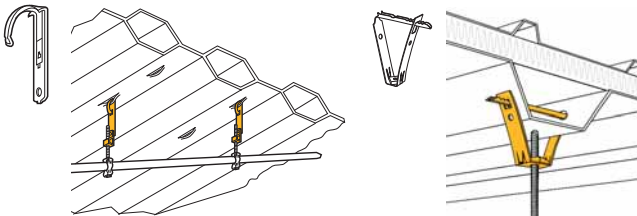

SEE PAGE 141

SEE PAGE 74, 75, 142



Applications

HANGERS/HANGING SYSTEMS

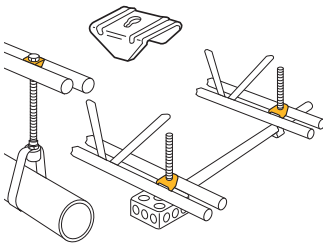

SEE PAGE 137

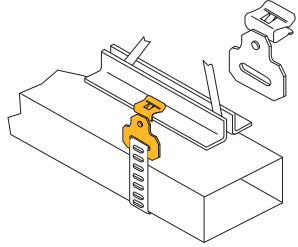

SEE PAGE 143

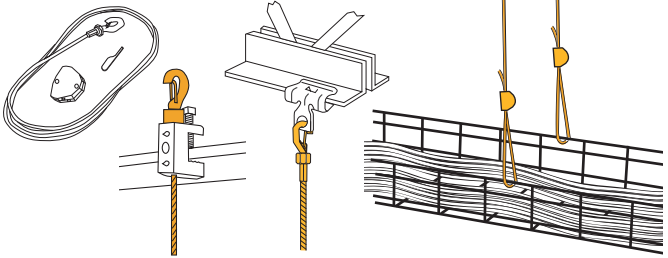

SEE PAGE 144-148

STUD WALL

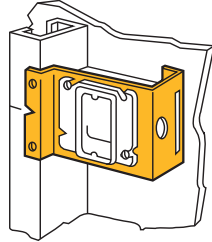
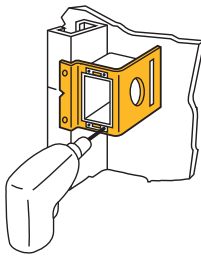
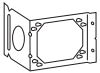

SEE PAGE 150

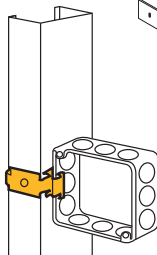
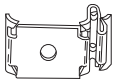

SEE PAGE 155

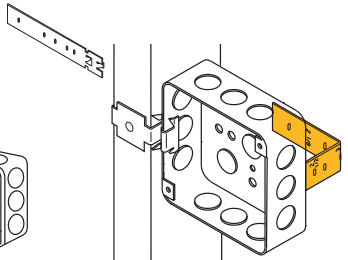

SEE PAGE 156

Applications

STUD WALL

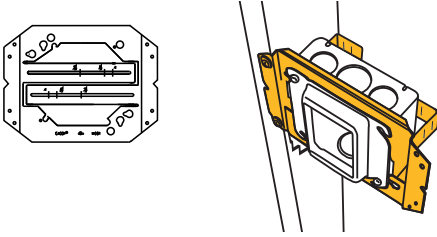

SEE PAGE 153

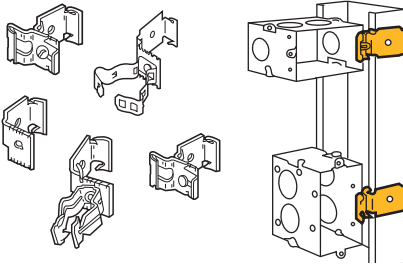

SEE PAGE 157

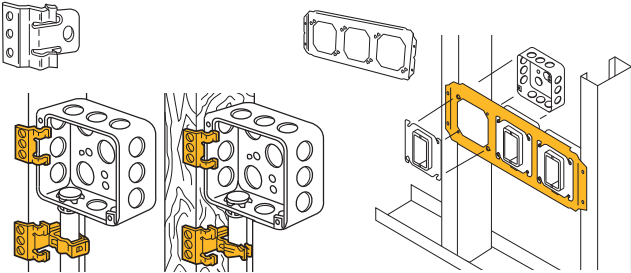

SEE PAGE 156

SEE PAGE 160

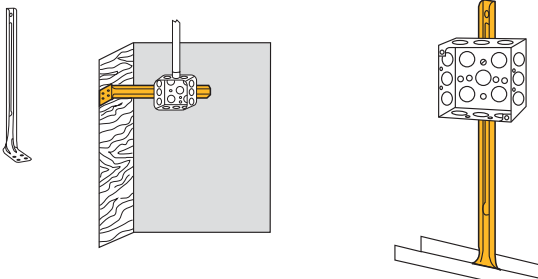

SEE PAGE 164



Applications

STUD WALL

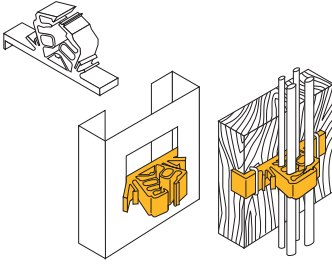

SEE PAGE 167

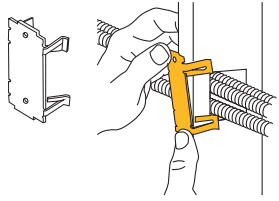

SEE PAGE 154

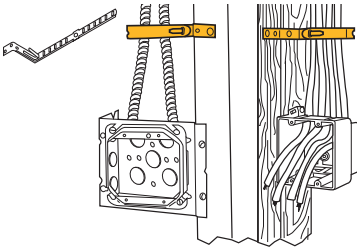

SEE PAGE 169

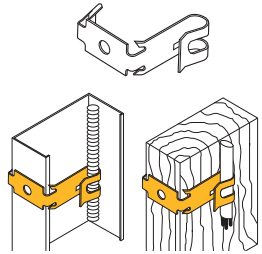

SEE PAGE 170

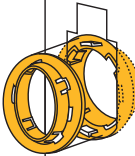
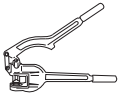

SEE PAGE 172

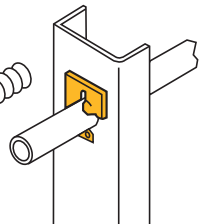
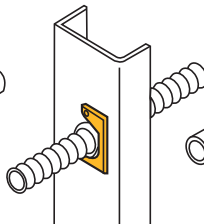
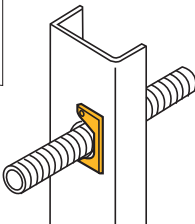

SEE PAGE 170

Applications

STUD WALL

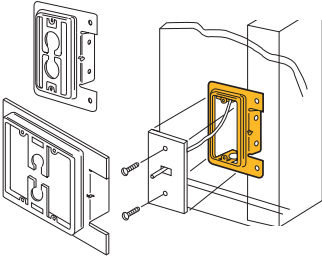

SEE PAGE 166, 209

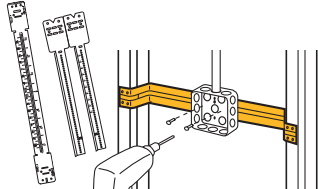

SEE PAGE 161, 162

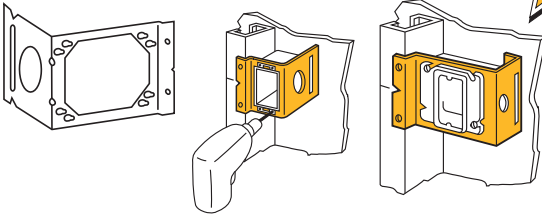

SEE PAGE 150

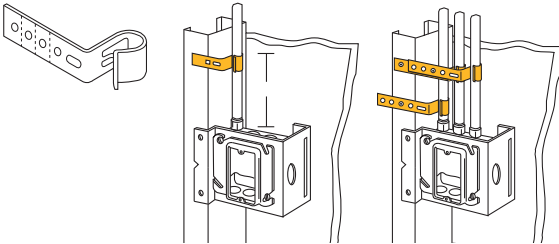

SEE PAGE 152

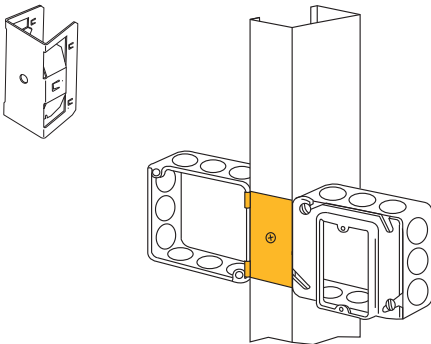

SEE PAGE 155



Applications

STUD WALL

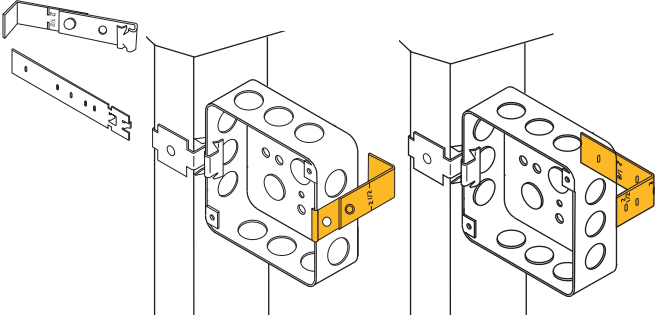

SEE PAGE 156

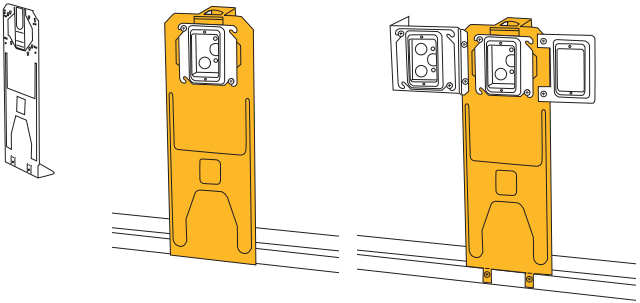

SEE PAGE 165

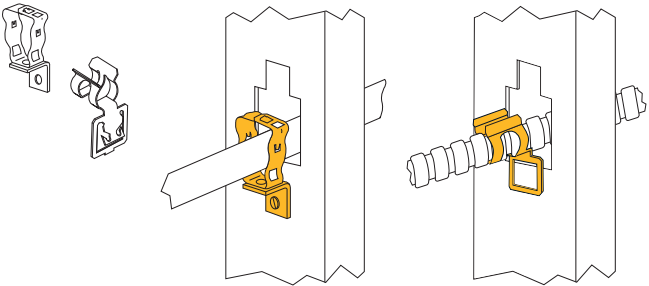

SEE PAGE 171

Applications

DRYWALL

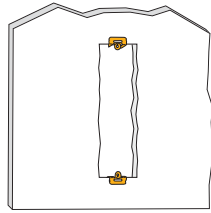
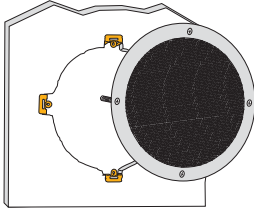

SEE PAGE 177

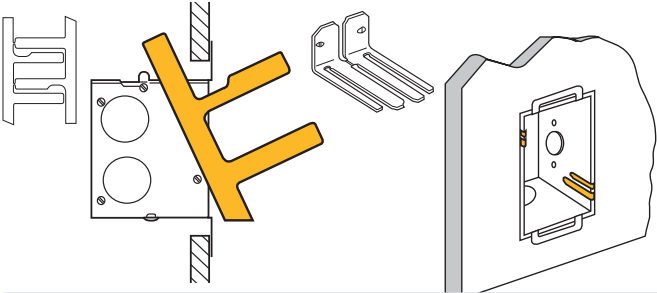

SEE PAGE 176

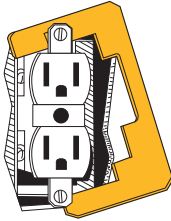
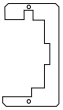

SEE PAGE 177

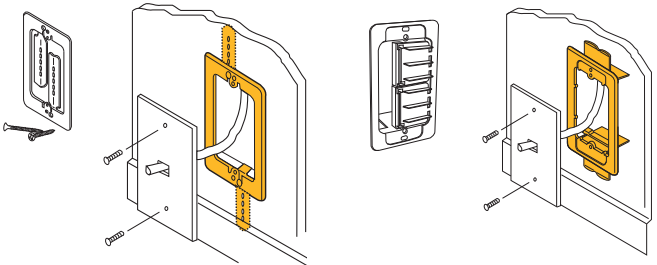

SEE PAGE 150

SEE PAGE 178, 179



Applications

LOW VOLTAGE/DATACOMM

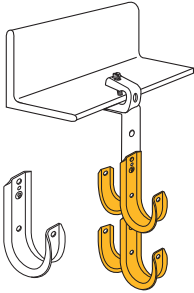

SEE PAGES 182-193

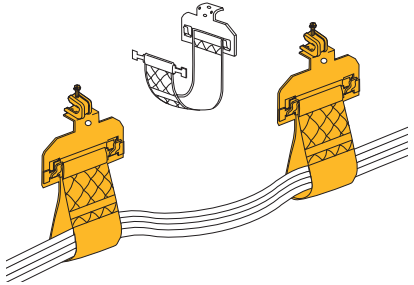

SEE PAGE 196, 197

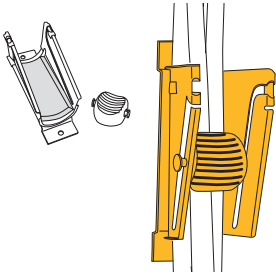

SEE PAGE 195

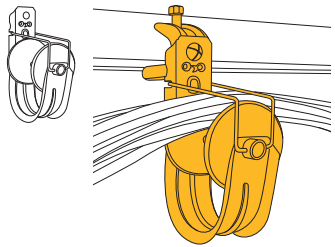

SEE PAGE 194

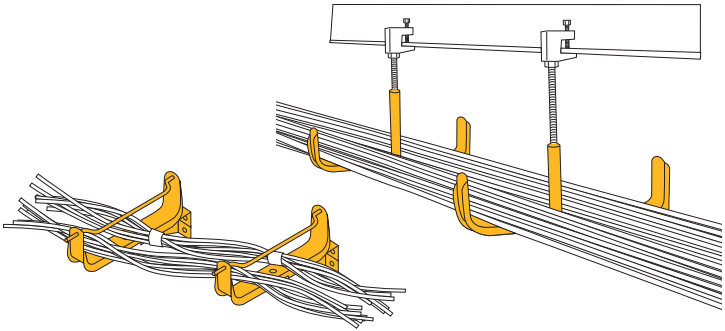

SEE PAGES 198, 199

Applications

LOW VOLTAGE/DATACOMM

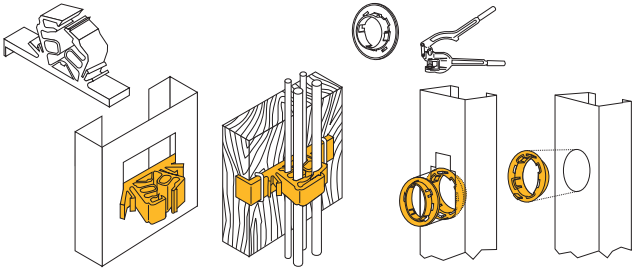

SEE PAGE 167

SEE PAGE 172

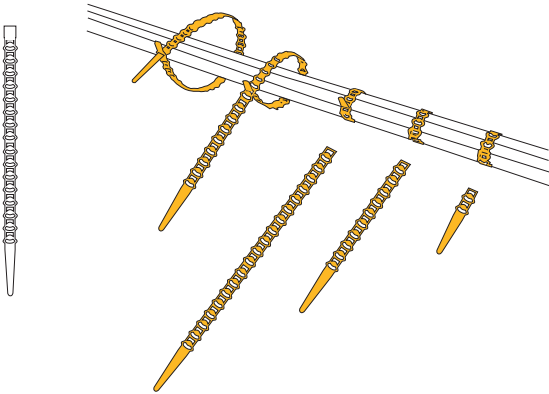

SEE PAGE 204

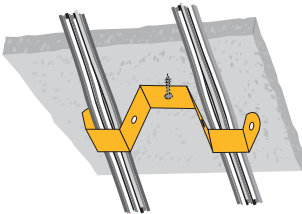

SEE PAGE 198, 199

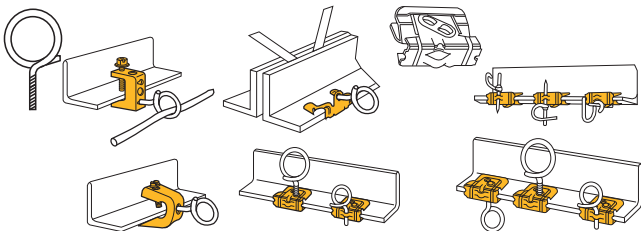

SEE PAGE 202

SEE PAGE 200-202



Applications

ACOUSTICAL

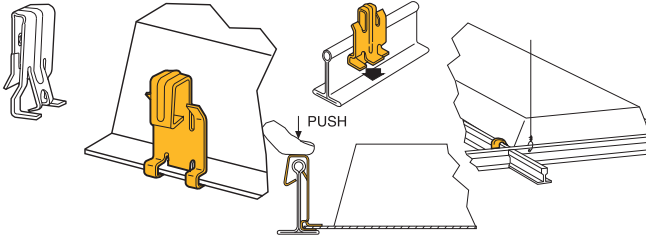

SEE PAGE 217

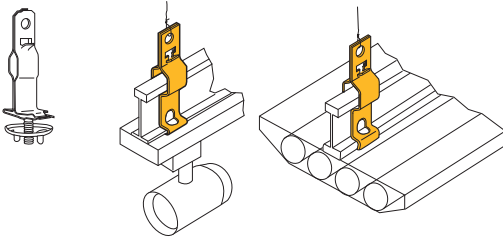

SEE PAGE 219

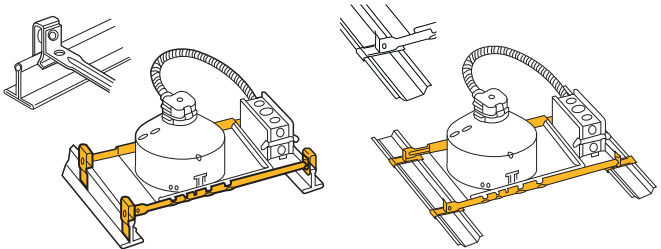

SEE PAGE 225

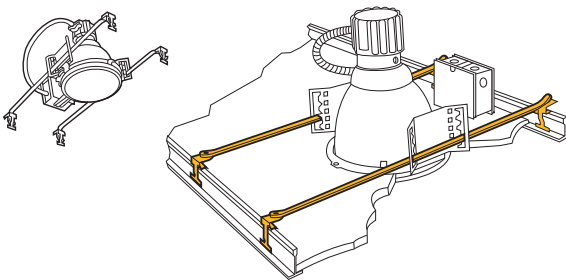

SEE PAGE 219

Applications

ACOUSTICAL

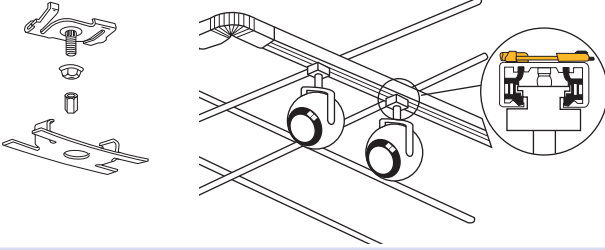

SEE PAGE 225

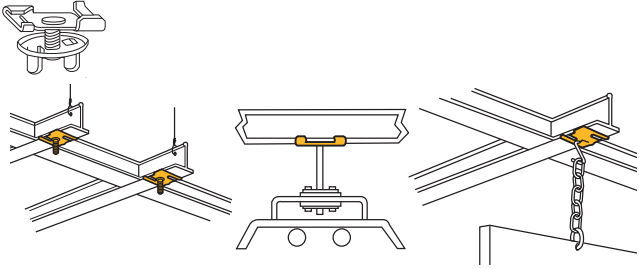

SEE PAGE 226

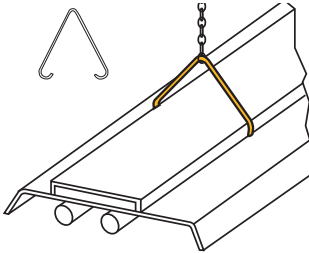

SEE PAGE 228

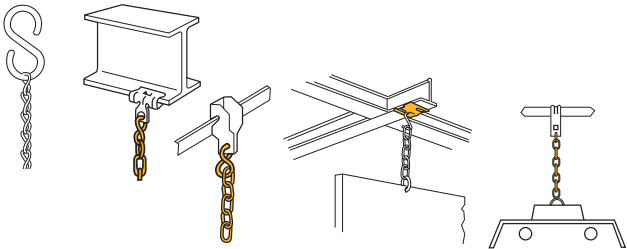

SEE PAGE 228



Applications

ACOUSTICAL

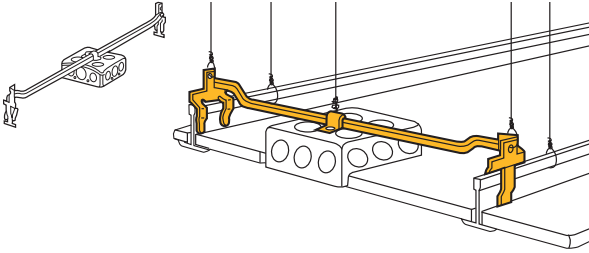

SEE PAGE 220

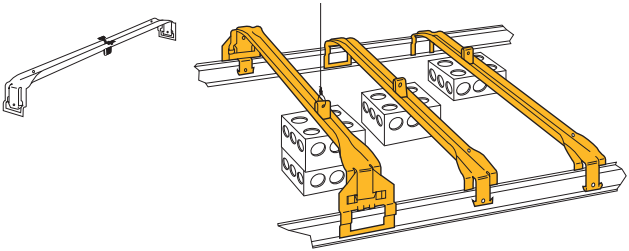

SEE PAGE 221

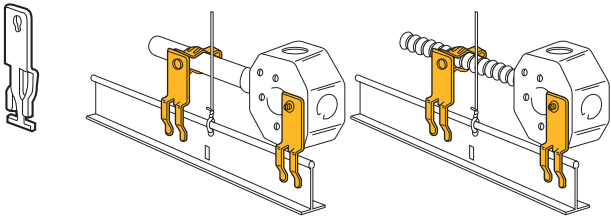

SEE PAGE 218

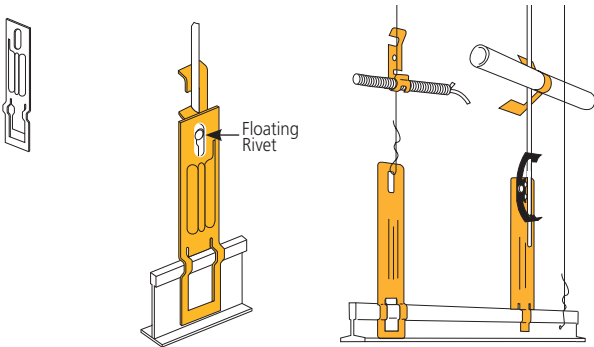

SEE PAGE 229

Applications

ACOUSTICAL

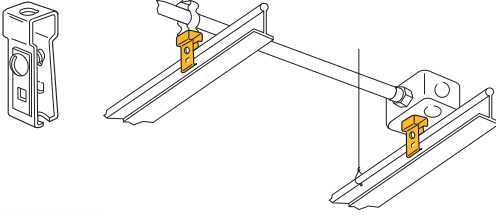

SEE PAGE 231

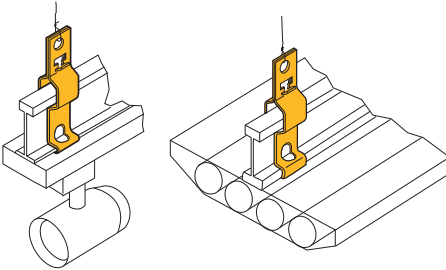

SEE PAGE 219

CEILING/PARTITIONS

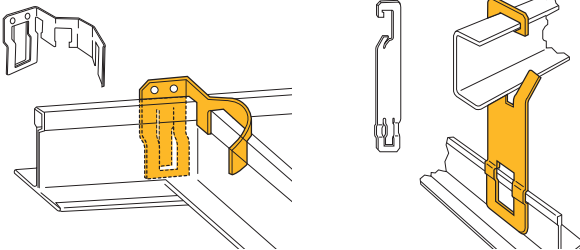

SEE PAGE 217

SEE PAGE 233

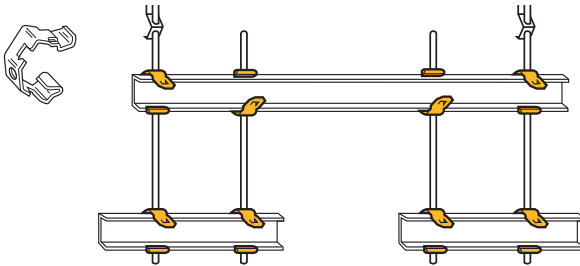

SEE PAGE 232



Applications

CEILING/PARTITIONS

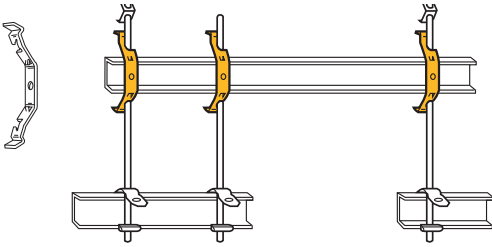

SEE PAGE 232

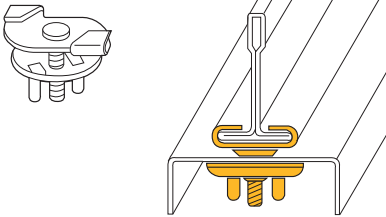

SEE PAGE 227

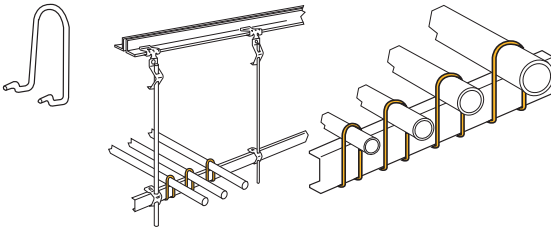

SEE PAGE 227

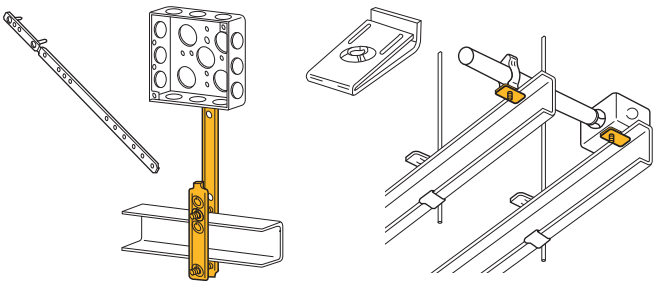

SEE PAGE 234

Applications

MISC. COMPONENTS

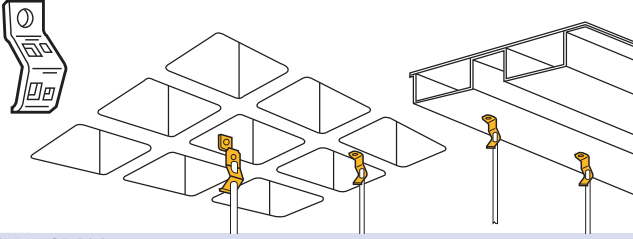

SEE PAGE 236

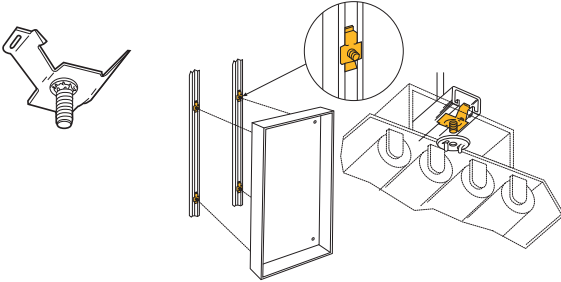

SEE PAGE 237

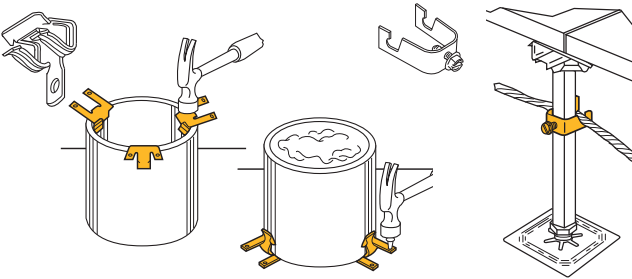

SEE PAGE 238



2011 National Electrical Code®

2009 Canadian Electrical Code®

A handbook of recommended
CADDY® Fasteners for easy
compliance to the fastening
requirements of the 2011 NEC®
and 2009 CEC®



NEC (pages 36-50) is a registered trademark of, and the National Electric Code (NEC) standard is a copyright of the National Fire Protection Association.

CEC (pages 51-52) is a registered trademark of, and the Canadian Electric Code (CEC) standard is a copyright of the Canadian Standards Association International.

Code Compliance

The intent of this publication is to help the electrical industry meet the 2011 National Electrical Code requirements in North America as they relate to fastening applications. (See page 51 for 2009 Canadian Electrical Code.) Shown are a variety of solutions.

NOTE: Consult the AHJ (authority having jurisdiction) as local codes may supersede the National Electrical Code® – ERICO.

2011 NEC Article 90

Introduction

90.3 Code Arrangement.

Chapter 8 covers communications systems and is not subject to the requirements of Chapters 1 through 7 except where the requirements are specifically referenced in Chapter 8. [See page 47-48]

90.4 Enforcement.

...The authority having jurisdiction for enforcement of the Code has the responsibility for making interpretations of the rules, for deciding on the approval of equipment and materials, and for granting the special permission contemplated in a number of the rules.

By special permission, the authority having jurisdiction may waive specific requirements in this Code or permit alternative methods where it is assured that equivalent objectives can be achieved by establishing and maintaining effective safety.

2011 NEC Article 300

Wiring Methods

300.4 Protection Against Physical Damage.

Where subject to physical damage, conductors, raceways and cables shall be protected.

(B) Nonmetallic-Sheathed Cables and Electrical Nonmetallic Tubing through Metal Framing Members.

(1) **Nonmetallic-Sheathed Cable.** ... the cable shall be protected by listed bushings or listed grommets covering all metal edges that are securely fastened in the opening prior to installation of the cable. [See Fig. 1]

Reference
CEC 12-516
CEC 12-616

ESG1 Grommet for 360° Protection of Nonmetallic Sheathed Cable and Tubing. ("V" and "U" Shaped Grommets and Retrofit Bushings Disallowed. Grommets/Bushings must be listed.)

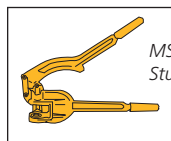

MSP20 Metal Stud Punch

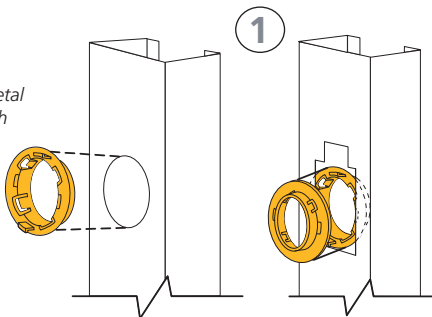

Code Compliance

300.4 Protection Against Physical Damage. (continued)

(D) Cables and Raceways Parallel to Framing Members.

...the cable or raceway shall be installed and supported...not less than 32 mm (1¼ in.) from the nearest edge of the framing member...where nails or screws are likely to penetrate. [See Fig. 2]

Where this distance cannot be maintained, the cable or raceway shall be protected from penetration by nails or screws by a steel plate, sleeve, or equivalent at least 1.6 mm (1/16 in.) thick... [See Fig. 3A & 9 on page 41]

Exception No. 3: A listed and marked steel plate less than 1.6 mm (1/16 in.) thick that provides equal or better protection against nail or screw penetration shall be permitted.

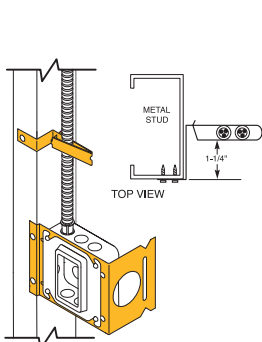

CJ6 Cable Support for MCIAC and Nonmetallic Sheathed Cable

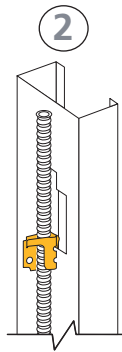

MAC2 Series for MCIAC Cable

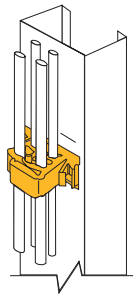

CG4 Cable Gripper for Nonmetallic Sheathed Cable or low-voltage wiring to wood and metal stud

Reference
CEC 12-510
CEC 12-516
CEC 12-618

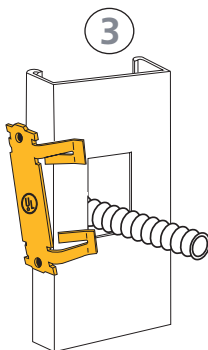

304B2 Press-on Protection Plates For Wood and Metal Studs

Reference
CEC 12-516
CEC 12-616

Code Compliance

300.11 Securing and Supporting.

(A) **Secured in Place.** Raceways, cable assemblies, boxes, cabinets and fittings shall be securely fastened in place. Support wires that do not provide secure support shall not be permitted as the sole support. Support wires and associated fittings that provide secure support and that are installed in addition to the ceiling grid support wires shall be permitted as the sole support. Where independent support wires are used, they shall be secured at both ends. Cables and raceways shall not be supported by ceiling grids.

(1) **Fire-Rated Assemblies.** Wiring located within the cavity of a fire-rated floor-ceiling or roof-ceiling assembly shall not be secured to, or supported by, the ceiling assembly, including the ceiling support wires. An independent means of secure support shall be provided and shall be permitted to be attached to the assembly. Where independent support wires are used, they shall be distinguishable by color, tagging, or other effective means from those that are part of the fire-rated design. [See Fig. 4A and 4B]

(2) **Non-Fire-Rated Assemblies.** Wiring located within the cavity of a non-fire-rated floor-ceiling or roof-ceiling assembly shall not be secured to, or supported by, the ceiling assembly, including the ceiling support wires. An independent means of secure support shall be provided and shall be permitted to be attached to the assembly. Where independent support wires are used, they shall be distinguishable by color, tagging, or other effective means. [See page 49 for more details relating to 300.11 and fastener solutions.]

4H24 Hammer-on Flange Clip

K or PCS Series Drop-Wire
Conduit & Cable Support

4T124 Hammer-on Rod Hanger

B18 Series Combination
Box/Conduit Hanger

EC311 Independent Electrical Drop-Wire Securing
Clips Distinguishable with Bright Yellow Color

4B

Drop Wire



Code Compliance

2011 NEC Article 310 Conductors for General Wiring

310.15 Ampacities for Conductors Rated 0-2000 Volts 310.15(B)(3) Adjustment Factors

Exception No. 4: Adjustment factors shall not apply to Type AC cable or to Type MC cable under the following conditions:

- (a) The cables do not have an overall outer jacket.
- (b) Each cable has not more than three current-carrying conductors.
- (c) The conductors are 12 AWG copper.
- (d) Not more than 20 current-carrying conductors are installed without maintaining spacing, are stacked or are supported on "bridle rings".

Exception No. 5: An adjustment factor of 60 percent shall be applied for Type AC cable or Type MC cable under the following conditions:

- (a) The cables do not have an overall outer jacket.
- (b) The number of current-carrying conductors exceeds 20.
- (c) The cables are stacked or bundled longer than 600 mm (24 in.) without spacing being maintained.

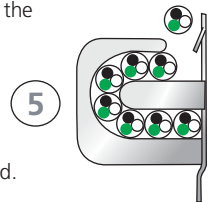

2011 NEC Article 314

Outlet, Device, Pull, and Junction Boxes; Conduit Bodies; Fittings; and Handhole Enclosures

314.23 Supports.

Enclosures within the scope of this article shall be supported in accordance with one or more of the provisions in 314.23(A) through (H).

(D) Suspended Ceilings. An enclosure mounted to structural or supporting elements of a suspended ceiling shall be not more than 1650 cm³ (100 in.³) in size and shall be securely fastened in place in accordance with either (D)(1) or (D)(2).

(1) Framing Members. An enclosure shall be fastened to the framing members by mechanical means such as bolts, screws, or rivets, or by the use of clips or other securing means identified for use with the type of ceiling framing member(s) and enclosure(s) employed. The framing members shall be adequately supported and securely fastened to each other and to the building structure. [See Fig. 6A]

(2) Support Wires. The installation shall comply with the provisions of 300.11(A). The enclosure shall be secured, using methods identified for the purpose, to ceiling support wire(s), including any additional support wire(s) installed for that purpose. Support wire(s) used for enclosure support shall be fastened at each end so as to be taut within the ceiling cavity. [See Fig. 6B]

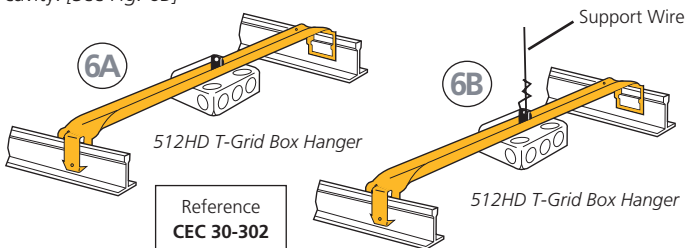

Code Compliance

314.23 Supports. (continued)

(E) **Raceway Supported Enclosure, Without Devices, Luminaires, or Lampholders.** Each conduit shall be secured within 900 mm (3 ft.) of the enclosure, or within 450 mm (18 in.) of the enclosure if all conduit entries are on the same side. [See Fig. 7A & 7B]

Consult Current NEC for Exceptions.

(F) **Raceway-Supported Enclosures, with Devices, Luminaires, or Lampholders.** Each conduit shall be secured within 450 mm. (18 in.) of the enclosure. [See Fig. 7C]

Consult Current NEC for Exceptions.

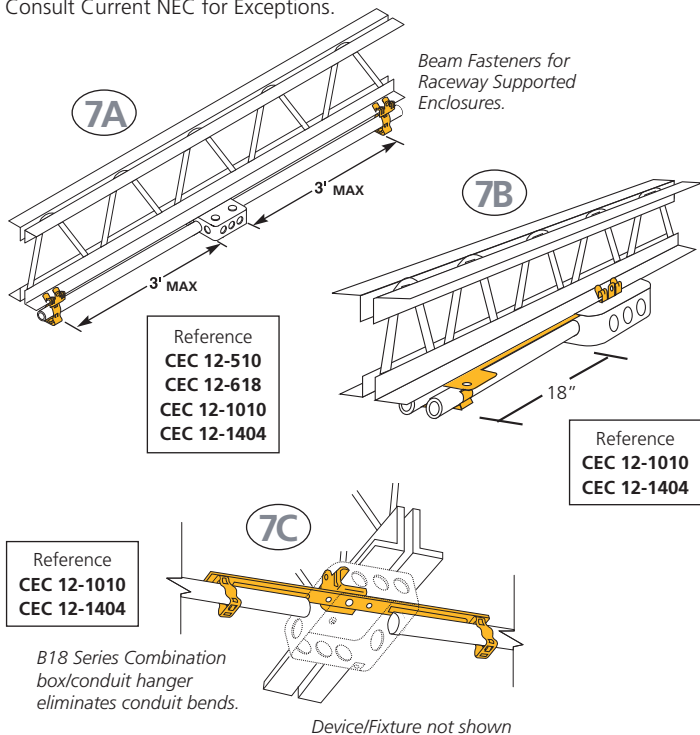

314.27 Outlet Boxes.

(A) **Boxes at Luminaire or Lampholder Outlets.** Outlet boxes or fittings designed for the support of luminaires and lampholders, and installed as required by 314.23, shall be permitted to support a luminaire or Lampholder.

(2) **Ceiling Outlets.** ... Boxes shall be required to support a luminaire weighing a minimum of 23 kg (50 lb). A luminaire that weighs more than 23 kg (50 lb) shall be supported independently of the outlet box, unless the outlet box is listed and marked for the maximum weight to be supported.



Code Compliance

2011 NEC Article 320

Armored Cable: Type AC

320.2 Definition.

Armored Cable, Type AC. A fabricated assembly of insulated conductors in a flexible interlocked metallic armor. See 320.100.

320.17 Through or Parallel to Framing Members.

Type AC cable shall be protected in accordance with 300.4...where installed through or parallel to framing members.

320.30 Securing and Supporting.

(A) **General.** Type AC cable shall be supported and secured by staples, cable ties, straps, hangers, or similar fittings, designed and installed so as not to damage the cable.

(B) **Securing.** Unless otherwise permitted, Type AC cable shall be secured within 300 mm (12 in.) of every outlet box, junction box, cabinet, or fitting and at intervals not exceeding 1.4 m (4-1/2 ft) where installed on or across framing members.

(C) **Supporting.** Unless otherwise permitted, Type AC cable shall be supported at intervals not exceeding 1.4 m (4-1/2 ft).

Horizontal runs of Type AC cable installed in wooden or metal framing members or similar supporting means shall be considered supported where such support does not exceed 1.4-m (4-1/2-ft) intervals.

320.80 Ampacity.

The ampacity shall be determined in accordance with 310.15.

[See Fig. 5 on page 39].

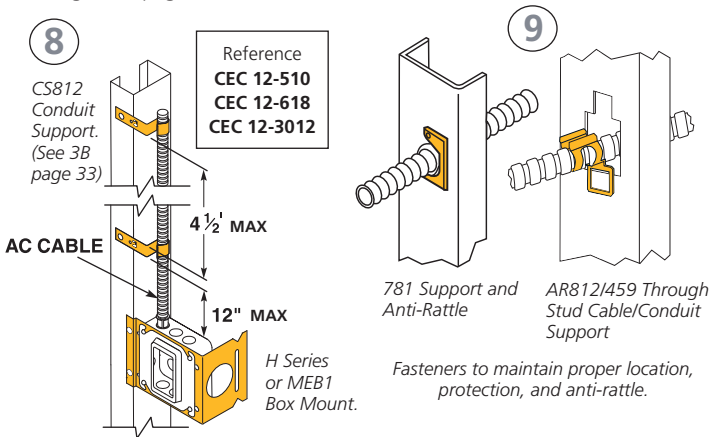

2011 NEC Article 330

Metal-Clad Cable: Type MC

330.2 Definition.

Metal Clad Cable, Type MC. A factory assembly of one or more insulated circuit conductors with or without optical fiber members enclosed in an armor of interlocking metal tape, or a smooth or corrugated metallic sheath.

330.17 Through or Parallel to Framing Members.

Type MC cable shall be protected in accordance with 300.4...where installed through or parallel to framing members.

Code Compliance

330.30 Securing and Supporting.

(A) **General.** Type MC cable shall be supported and secured by staples, cable ties, straps, hangers, or similar fittings or other approved means designed and installed so as not to damage the cable.

(B) **Securing.** Unless otherwise provided, cables shall be secured at intervals not exceeding 1.8 m (6 ft). Cables containing four or fewer conductors sized no larger than 10 AWG shall be secured within 300 mm (12 in.) of every box, cabinet, fitting, or other cable termination.

(C) **Supporting.** Unless otherwise provided, cables shall be supported at intervals not exceeding 1.8 m (6-ft).

Horizontal runs of Type MC cable installed in wooden or metal framing members or similar supporting means shall be considered supported and secured where such support does not exceed 1.8-m (6-ft) intervals.

330.80 Ampacity.

The ampacity of Type MC cable shall be determined in accordance with 310.15 or 310.60. [See Fig. 5 on page 39].

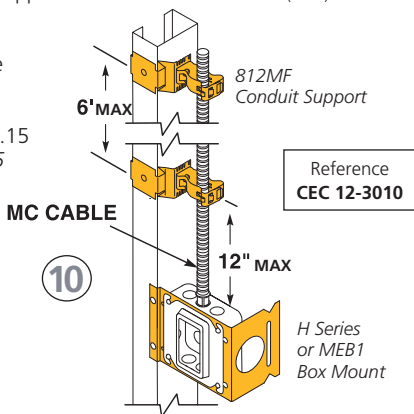

2011 NEC Article 334

Nonmetallic-Sheathed Cable: Types NM, NMC, and NMS

334.2 Definition.

Nonmetallic-Sheathed Cable. A factory assembly of two or more insulated conductors enclosed within an overall nonmetallic jacket.

334.17 Through or Parallel to Framing Members.

Types NM, NMC, or NMS cable shall be protected in accordance with 300.4 where installed through or parallel to framing members. Grommets used as required in 300.4(B)(1) shall remain in place and be listed for the purpose of cable protection. [See Fig. 1 on page 36]

334.30 Securing and Supporting.

Nonmetallic-sheathed cable shall be supported and secured by staples, cable ties, straps, hangers, or similar fittings designed and installed so as not to damage the cable, at intervals not exceeding 1.4 m (4-1/2 ft) and within 300 mm (12 in.) of every outlet box, junction box, cabinet, or fitting.

(A) **Horizontal Runs through Holes and Notches.** In other than vertical runs, cables installed in accordance with 300.4 shall be considered supported and secured where such support does not exceed 1.4 m (4 1/2 ft.) intervals and the nonmetallic sheathed cable is securely fastened in place by an approved means within 300 mm. (12 in.) of each box, cabinet, conduit body, or other nonmetallic sheathed cable termination.



Code Compliance

NEC 2011 Article 342

Intermediate Metal Conduit: Type IMC

342.30 Securing and Supporting.

IMC shall be installed as a complete system in accordance with 300.18 and shall be securely fastened in place and supported in accordance with 342.30(A) and (B).

(A) **Securely Fastened.** Each IMC shall be secured in accordance with one of the following:

- (1) IMC shall be securely fastened within 900 mm. (3 ft.) of each outlet box, junction box, device box, cabinet, conduit body, or other conduit termination.
- (2) Where structural members do not readily permit fastening within 900 mm. (3 ft), fastening shall be permitted to be increased to a distance of 1.5 m. (5 ft.).
- (3) Where approved, conduit shall not be required to be securely fastened within 900 mm. (3 ft.) of the service head for above - the - roof termination of a mast.

(B) **Supports.** IMC shall be supported in accordance with one of the following:

- (1) Conduit shall be supported at intervals not exceeding 3 m. (10 ft).

[See Fig. 12A]

- (2) The distance between supports for straight runs of conduit shall be permitted in accordance with Table 344.30(B)(2), provided the conduit is made up with threaded couplings and such supports prevent transmission of stresses to termination where conduit is deflected between supports.

NEC 2011 Article 344

Rigid Metal Conduit: Type RMC

344.30 Securing and Supporting.

RMC shall be installed as a complete system in accordance with 300.18 and shall be securely fastened in place and supported in accordance with 344.30(A) and (B).

(A) **Securely Fastened.** RMC shall be securely fastened within 900 mm.

(3 ft.) of each outlet box, junction box, device box, cabinet, conduit body, or other conduit termination. Fastening shall be permitted to be increased to a distance of 1.5 m. (5 ft.) where structural members do not readily permit fastening within 900 mm. (3 ft.). Where approved, conduit shall not be required to be securely fastened within 900 mm. (3 ft.) of the service head for above-the-roof termination of a mast. [See Fig. 6]

(B) **Supports.** RMC shall be supported in accordance with one of the following.

- (1) Conduit shall be supported at intervals not exceeding 3 m. (10 ft.).

(2) The distance between supports for straight runs of conduit shall be permitted in accordance with Table 346.30(B)(2), provided the conduit is made up with threaded couplings, and such supports prevent transmission of stresses to termination where conduit is deflected between supports. [See Fig. 11]

CADDY® PYRAMID
Pipe & Equipment Supports:
Alternative to wood blocks
for roof top applications.

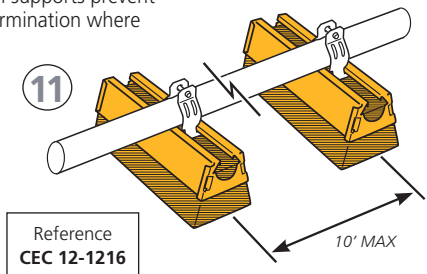

Code Compliance

2011 NEC Article 358

Electrical Metallic Tubing: Type EMT

358.30 Securing and Supporting.

EMT shall be installed as a complete system in accordance with 300.18 and shall be securely fastened in place and supported in accordance with 358.30(A) and (B).

(A) **Securely Fastened.** EMT shall be securely fastened in place at least every 3 m. (10 ft.). In addition, each EMT run between termination points shall be securely fastened within 900 mm. (3 ft.) of each outlet box, junction box, device box, cabinet, conduit body, or other tubing termination. [See Fig. 12A]

(B) **Supports.** Horizontal runs of EMT supported by openings through framing members at intervals not greater than 3 m. (10 ft.) and securely fastened within 900 mm. (3 ft.) of termination points shall be permitted. [See Fig. 12A & 12B]

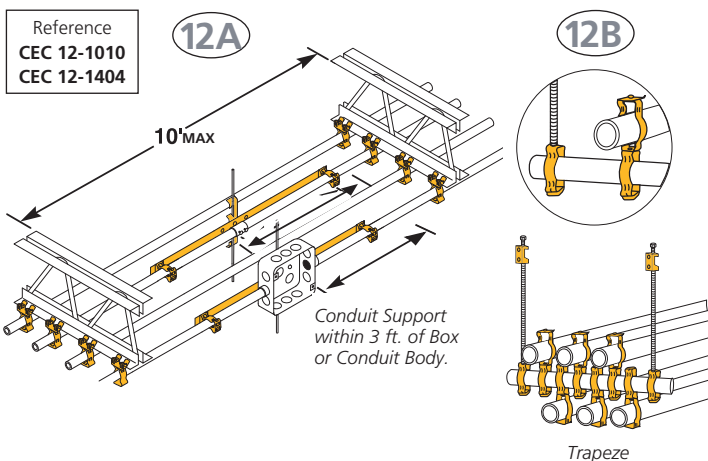

2011 NEC Article 362

Electrical Nonmetallic Tubing: Type ENT

362.2 Definition.

Electrical Nonmetallic Tubing (ENT). A nonmetallic pliable corrugated raceway of circular cross section with integral or associated couplings, connectors, and fittings for the installation of electric conductors. ENT is composed of a material that is resistant to moisture and chemical atmospheres and is flame retardant. A pliable raceway is a raceway that can be bent by hand with a reasonable force, but without other assistance.

362.30 Securing and Supporting.

ENT shall be installed as a complete system in accordance with 300.18 and shall be securely fastened in place and supported in accordance with 362.30(A) and (B).

(A) **Securely Fastened.** ENT shall be securely fastened at intervals not exceeding 900 mm. (3 ft.). In addition, ENT shall be securely fastened in place within 900 mm. (3 ft.) of each outlet box, device box, junction box, cabinet, or fitting where it terminates. [See Fig. 13]



Code Compliance

2011 NEC Article 392 Cable Trays

392.1 Scope.

This article covers cable tray systems, including ladder, ventilated trough, ventilated channel, solid bottom, and other similar structures.

Informational Note: For further information on cable trays, see ANSI/NEMA-VE 1-2002, Metal Cable Tray Systems; NECA/NEMA 105-2007, Standard for Installing Metal Cable Tray Systems, and NEMA-FG 1-1998, Nonmetallic Cable Tray Systems.

392.2 Definition.

Cable Tray System. A unit or assembly of units or sections and associated fittings forming a structural system used to securely fasten or support cables and raceways.

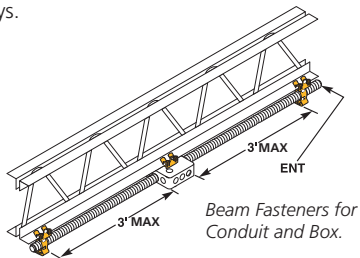

13

Reference
CEC 12-1504

2011 NEC Article 410 Luminaires (Lighting Fixtures), Lampholders, and Lamps

410.36 Means of Support.

(A) **Outlet Boxes.** Outlet boxes or fittings installed as required by 314.23 and complying with the provisions of 314.27(A)(1) and 314.27(A)(2) shall be permitted to support luminaires. [See 6B on page 39]

(B) **Suspended Ceilings.** Suspended Ceilings. Framing members of suspended ceiling systems used to support luminaires shall be securely fastened to each other and shall be securely attached to the building structure at appropriate intervals. Luminaires shall be securely fastened to the ceiling framing member by mechanical means such as bolts, screws, or rivets. Listed clips identified for use with the type of ceiling framing member(s) and luminaire(s) shall also be permitted. [See Fig. 14, 15A, 15B & 16]

Outlet Box Not Shown

Reference
CEC 30-302

14



IDS Series Independent Support
Clip for Surface-mounted Fixture.

15B

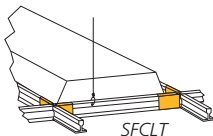

SFCLT

15A

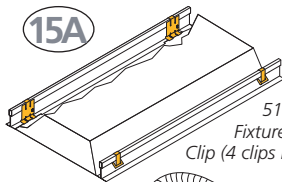

515A Lay-in
Fixture Retainer
Clip (4 clips required).

16

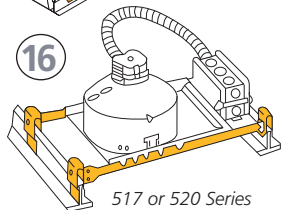

517 or 520 Series
High Hat Fixture Support

Code Compliance

410.36 Means of Support. (continued)

[Article 100-Definitions]

***Listed.** Equipment, materials, or services included in a list published by an organization that is acceptable to the authority having jurisdiction and concerned with evaluation of products or services, that maintains periodic inspection of production of listed equipment or materials or periodic evaluation of services, and whose listing states that either the equipment, material, or services meets appropriate designated standards or has been tested and found suitable for a specified purpose.

Informational Note: The means for identifying listed equipment may vary for each organization concerned with product evaluation, some of which do not recognize equipment as listed unless it is also labeled. Use of the system employed by the listing organization allows the authority having jurisdiction to identify a listed product.

410.154 Fastening. Lighting track shall be securely mounted so that each fastening will be suitable for supporting the maximum weight of luminaires that can be installed. Unless identified for supports at greater intervals, a single section 1.2 m. (4 ft.) or shorter in length shall have two supports, and, where installed in a continuous row, each individual section of not more than 1.2 m. (4 ft.) in length shall have one additional support.

[See Fig. 17A & 17B]

590.4 General.

(J) **Support.** Cable assemblies and flexible cords and cables shall be supported in place at intervals that ensure that they will be protected from physical damage. Support shall be in the form of staples, cable ties, straps, or similar type fittings installed so as not to cause damage. Vegetation shall not be used for support of overhead spans of branch circuits or feeders.

Exception: For holiday lighting in accordance with 590.3(B), where the conductors or cables are arranged with strain relief devices, tension take-up devices, or other approved means to avoid damage from the movement of the live vegetation, trees shall be permitted to be used for support of overhead spans of branch circuit conductors or cables.

604.7 Construction.

Installation. Manufactured wiring systems shall be secured and supported in accordance with the applicable cable or conduit article for the cable or conduit type employed.

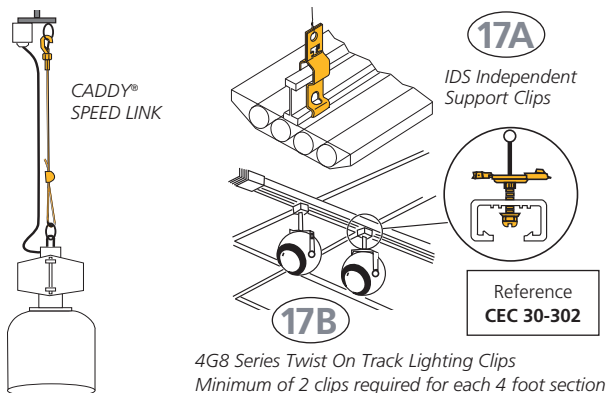

Code Compliance

NEC 2011 Article 725

Class 1, Class 2, and Class 3 Remote Control, Signaling, and Power-Limited Circuits

725.24 Mechanical Execution of Work.

Class 1, Class 2, and Class 3 circuits shall be installed in a neat and workmanlike manner. Cables and conductors installed exposed on the surface of ceilings and sidewalls shall be supported by the building structure in such a manner that the cable will not be damaged by normal building use. Such cables shall be supported by straps, staples, hangers, cable ties, or similar fittings designed and installed so as not to damage the cable. The installation shall also conform with 300.4(D).

NEC 2011 Article 760

Fire Alarms

760.24 Mechanical Execution of Work.

Fire alarm circuits shall be installed in a neat workmanlike manner. Cables and conductors installed exposed on the surface of ceilings and sidewalls shall be supported by the building structure in such a manner that the cable will not be damaged by normal building use. Such cables shall be supported by straps, staples, cable ties, hangers, or similar fittings designed and installed so as not to damage the cable. The installation shall also conform with 300.4(D).

NEC 2011 Article 770

Optical Fiber Cables and Raceways

770.24 Mechanical Execution of Work.

Optical fiber cables shall be installed in a neat and workmanlike manner. Cables installed exposed on the surface of ceilings and sidewalls shall be supported by the building structure in such a manner that the cable will not be damaged by normal building use. Such cables shall be secured by hardware including straps, staples, cable ties, hangers, or similar fittings designed and installed so as not to damage the cable. The installation shall also conform with 300.4(D) and 300.11.

Informational Note No. 1: Accepted industry practices are described in ANSI/NECA/BICSI 568-2001, Standard for Installing Commercial Building Telecommunications Cabling, ANSI/NECA/FOA 301-2004, Standard for Installing and Testing Fiber Optic Cable, and other ANSI-approved installation standards.

NEC 2011 Article 800

Communications Circuits

800.24 Mechanical Execution of Work.

Communications circuits and equipment shall be installed in a neat and workmanlike manner. Cables installed exposed on the surface of ceilings and sidewalls shall be supported by the building structure in such a manner that the cable will not be damaged by normal building use. Such cables shall be secured by hardware including straps, staples, cable ties, hangers, or similar fittings designed and installed so as not to damage the cable. The installation shall also conform with 300.4(D) and 300.11.

Informational Note No. 1: Accepted industry practices are described in ANSI/NECA/BICSI 568-2006, Standard for Installing Commercial Building Telecommunications Cabling, ANSI/TIA/EIA-568-B.1-2004 – Part 1, General Requirements Commercial Building Telecommunications Cabling Standard, ANSI/TIA-569-B-2004, Commercial Building Standard for Telecommunications Pathways and Spaces, ANSI/TIA-570-B, Residential Telecommunications Infrastructure, and other ANSI-approved installation standards.

Code Compliance

NEC 2005 Article 800 Communications Circuits (continued)

800.133 Installation of Communications Wires, Cables, and Equipment

(B) *Support of Communications Wires and Cables.* Raceways shall be used for their intended purpose. Communications wires and cables shall not be strapped, taped, or attached by any means to the exterior of any raceway as a means of support.

800.154 Applications of Listed Communications Wires, Cables and Raceways.

Permitted and nonpermitted applications of Listed Communications Wires, Cables and Raceways shall be as indicated in Table 800-154(a). The permitted applications shall be subject to the installation requirements of 800-110 and 800-113.

CADDY® CABLECAT Vertical Backbone Cable Supports

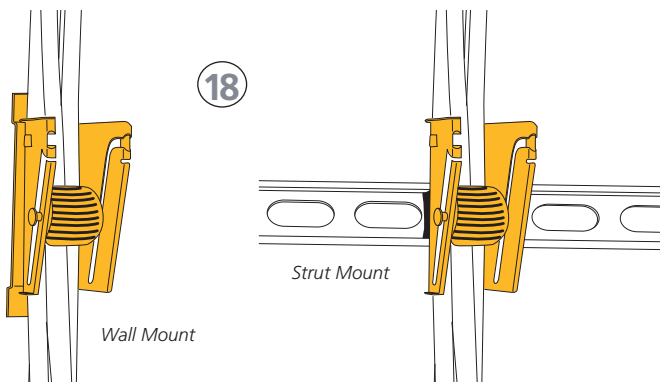

Code Compliance

Commentary from ERICO

Article 300-11 has resulted in more phone calls to ERICO than ever regarding code compliance. As a result we have discussed the code with electricians and inspectors from coast to coast. The following is a summation of these conversations. Always check with your local inspectors prior to installation.

Additional Drop-Wire and Drop-Rod Supports:

Although wiring can no longer be attached to drop wires/rods that support the suspended ceiling, additional dedicated wires/rods can be dropped separately to support wiring assembly. These drop wires/rods shall be properly secured (anchored) at both ends.

Fig. 21 EC311 Independent Electrical Drop-Wire Securing Clip attaches to the ceiling grid. Its bright yellow color allows it to be distinguished from ceiling wires and easily identified by inspectors.

Fig. 22 In case of a fire emergency in which the ceiling grid may be torn down, ERICO recommends the use of a clip that will release without stress on the electrical system.

Fig. 23 B18 Series: Using B18 series will reduce the number of drop wires needed. B18 series supports conduit on either side of a junction box. Holes in opposite ends of 18" bar accommodate 812M, 16M, 8P, 12P (etc.) conduit clips. A center hole accepts M24S, 4Z34, 6Z34 fasteners for attachment to threaded rod. Also complies with NEC Article 358.30. 2011 code now applies to low voltage cabling [See Fig. 22]

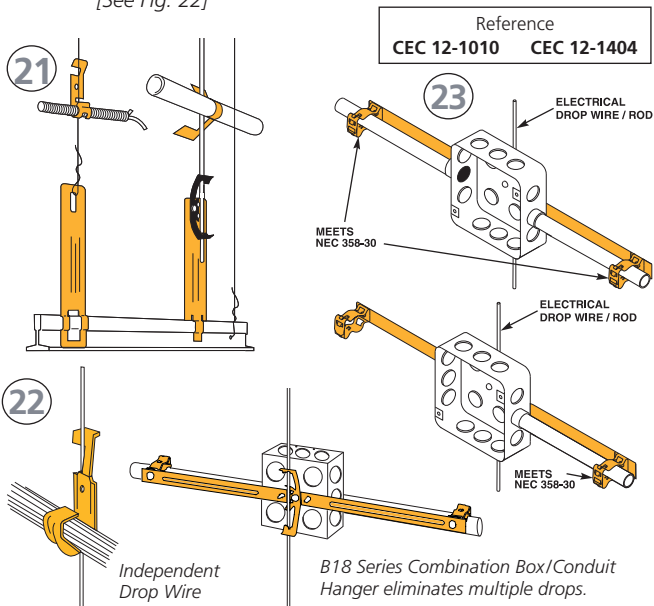

Commentary (continued)

Fig. 24 PCS Series: Supports wiring from independent drop wires/rods. These will support MC/AC, 1/2 in. and 3/4 in. EMT and MC/AC cable. PCS will not bend the drop wire/rod, and is 25% faster to install than other methods.

Fig. 25 Trapeze: First attach threaded rods to the support structure with the CADDY® BC Series. Then, support the trapeze by using CADDY 16M4I series light weight trapeze clips. Use back-to-back M series to support 3/8 in. MC/AC cable through 1 in. conduits.

Fig. 26 and 27 For purlin applications: AF14 or VF14 series is designed for "C" [Fig. 24] or "Z" [Fig. 25] purlin that fits flanges from 1/16 in. to 1/4 in. There is a special tool, VAFT, designed for installing these fasteners from the ground - eliminating the need for ladders.

Fig. 28 Hammer-on clips can be installed directly to I-beams.

Fig. 29 Angle brackets are available for hanging plain or threaded rod to support raceway systems.

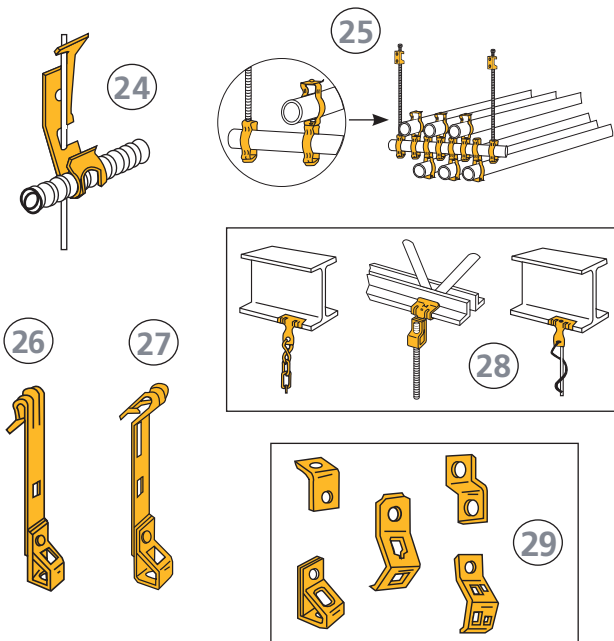

Reprinted with permission from NFPA 70®-2011, National Electrical Code®, Copyright © 2010, National Fire Protection Association, Quincy, MA. This reprinted material is not the complete and official position of the NFPA on the referenced subject, which is represented only by the standard in its entirety.



2009 CANADIAN ELECTRICAL CODE

CEC 2009 Section 12 Wiring Methods

Nonmetallic Sheathed Cable

12-510 Running of Cable Between Boxes and Fittings

- (1) Where the cable is run between boxes and fittings, it shall be supported by straps or other devices located within 300 mm. of every box or fitting and at intervals of not more than 1.5 m. throughout the run. [See Fig. 2, 6 & 9]

12-516 Protection for Cable in Concealed Installations

- (1) Where the cable is run through studs, joists, or similar members, the outer surfaces of the cable shall be kept to a distant of at least 32 mm. from the edges of the members or the cable shall be effectively protected from mechanical injury. [See Fig. 1, 3A & 3B]
- (2) Where the cable is run through or along metal studs, joists, sheathing, or cladding, it shall be:
 - (b) Protected where it passes through a member by an insert approved for the purpose and adequately secured in place; and [See Fig. 1]
- (3) Where the cable is installed immediately behind a baseboard, it shall be effectively protected from mechanical injury from driven nails. [See Fig. 3A]

Armoured Cable

12-616 Concealed Armoured Cable Installation

- (1) Where armoured cable is run through studs, joists, or other members, the outer surfaces of the cable shall be:
 - (a) Located so that the outer circumference is at least 32 mm. from the nearest edge of the members; or
 - (b) Protected from mechanical injury where it passes through the holes in the members. [See Fig. 1 & 3]
- (2) Where armoured cable is installed immediately behind baseboards, it shall be protected from mechanical injury from driven nails. [See Fig. 3A]

12-618 Running of Cable Between Boxes, Etc.

Armoured cable shall be supported between boxes and fittings in accordance with Rule 12-510. [See Fig. 2, 6 & 9]

Rigid and Flexible Metal Conduit

12-1010 Maximum Spacing of Conduit Supports

- (1) All rigid metal conduit of one size shall be securely attached to hangers or to a solid surface with the maximum spacings of the points of support not greater than:
 - (a) 1.5 m. for 16 and 21 trade size conduit;
 - (b) 2 m. for 27 and 35 trade size conduit; and
 - (c) 3 m. for 41 trade size conduit and larger.
- (2) Where rigid metal conduits of mixed sizes are run in a group, the conduit supports shall be arranged so that the maximum support spacing will be that shown in Subrule (1) for the smallest conduit.

2009 CANADIAN ELECTRICAL CODE

- (3) When flexible metal conduit is installed, it shall be secured at intervals not exceeding 1.5 m. and within 300 mm. on each side of every outlet box or fitting except where flexible metal conduit is fished and except for lengths of not over 900 mm. at terminals where flexibility is necessary. [See Fig. 6, 7, 8, 12A & 22]

Rigid RTRC Conduit

12-1216 Conduit Supports

Where rigid RTRC conduit Type AG is run in accordance with Rule 12-1202(2) it shall be supported with hangers or clamps:

- In such a manner as to permit adequate linear movement to allow for expansion and contraction due to temperature change; and
- With spacings of the supports not greater than permitted by Rule 12-1010. [See Fig. 11]

Electrical Metallic Tubing

12-1404 Supports

Electrical metallic tubing shall be installed as a complete system and shall be securely fastened in place within 1 m. of each outlet box, junction box, cabinet, coupling, or fitting, and the spacing between supports shall be in accordance with those specified in Rule 12-1010. [See Fig. 6, 7, 8, 12A, 12B & 22]

Electrical Non-Metallic Tubing

12-1504 Supports

Electrical nonmetallic tubing shall be securely fastened in place within 1 m. of each outlet box, junction box, cabinet, coupling or fitting, and the spacing between supports shall be not more than 1 m. [See Fig. 5 & 13]

Installations of Boxes, Cabinets, Outlets, and Terminal Fittings

12-3010 Outlet box Supports

- Except as permitted by Subrule (6), boxes and fittings shall be firmly secured to studs, joists, or similar fixed structural units other than wooden, metal, or composition lath, in accordance with this Rule.
- Where boxes are mounted on metal studs, additional support shall be provided to prevent movement of the box after the drywall is installed. [See Fig. 9 & 10]

CEC 2009 Section 30 Installation of Lighting Equipment

30-302 Supports

- Every luminaire shall be securely supported. [See Fig. 5A, 5B, 14, 15, 16, 17A & 17B]
- Where the weight of a luminaire does not exceed 13 kg., the luminaire shall be permitted to be supported by a wall outlet box attached directly to the building structure or by a wall outlet box attached to a bar hanger. [See Fig. 5A]
- Where the weight of a luminaire does not exceed 23 kg., the luminaire shall be permitted to be supported by a ceiling outlet box attached directly to the building structure or by a ceiling outlet box attached to a bar hanger. [See Fig. 5B & 15]



Reproduced with the permission of CSA from C22.1-09 - Canadian electrical code, part I (21st edition), safety standard for electrical installations which is copyrighted by CSA. While use of this material has been authorized, CSA shall not be responsible for the manner in which the information is presented, nor for any interpretations thereof.

Cable/Conduit

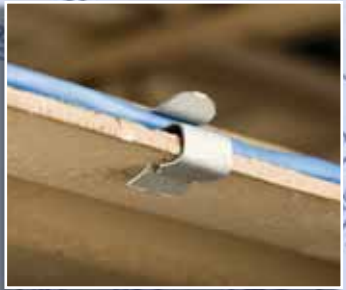

Cable/Conduit

Conduit Clips

Features

- Spring steel M Clips have finger closure
- Spring steel P Clips have push-in installation
- Helps to guide alignment with electrical box knockouts.
- 9/32" plain hole or 1/4"-20 thread impression options for mounting and field assembly to structure fasteners



Fig. #1

Patent Number: 5,533,696

Part Number	Fig. #	Conduit Size (in)	Mounting Hole (in)	Standard Packaging Quantity
6M*	1	For 14-2 thru 12-3 MC/AC and 3/8 Flexible Conduit	9/32 Plain	100
812M*	1	1/2 to 3/4	9/32 Plain	100
16M*	1	1	9/32 Plain	100
20M*	1	1 1/4	9/32 Plain	100
24M*	1	1 1/2	9/32 Plain	100
32M*	1	2	9/32 Plain	100
812M4I*	1	1/2 to 3/4	1/4-20 Thread Impression	100
6M4I*	1	For 14-2 thru 12-3 MC/AC and 3/8 Flexible Conduit	1/4-20 Thread Impression	100
16M4I*	1	1	1/4-20 Thread Impression	100
20M4I*	1	1 1/4	1/4-20 Thread Impression	100
24M4I*	1	1 1/2	1/4-20 Thread Impression	100
32M4I*	1	2	1/4-20 Thread Impression	100
8P†	2	1/2	9/32 Plain	100
12P†	2	3/4	9/32 Plain	100
16P†	2	1	9/32 Plain	100
8P4I†	2	1/2	1/4-20 Thread Impression	100
12P4I†	2	3/4	1/4-20 Thread Impression	100
16P4I†	2	1	1/4-20 Thread Impression	100

*M Series 100 lbs. Vertical • 25 lbs. Horizontal (static load)

†P Series 25 lbs. Vertical • 15 lbs. Horizontal (ultimate load)



Fig. #2



Combination Push-in Wall Clips



Features

- Ideal for EMT support between wall studs with SGB/TSGB series brackets
- Quickly attaches pipe, conduit, MC/AC and tube to wall surfaces
- Just push in - there's no need to close the clip
- Reduces the need to stock multiple products
- Standoff design reduces conduit bending
- Helps to guide alignment with electrical box knockouts
- Low-profile design minimizes snag potential
- Secure with powder-actuated tools, self-tapping concrete anchors or screw guns
- Lightweight, one-piece design

Part Number	Description	Standard Packaging Quantity
WC812	Combination Push-in Wall Clip 1/2" and 3/4" EMT conduit 1/2" Rigid, IMC, PVC SCH 40 5/8" & 3/4" Copper Tube MC/AC .700 - .925 OD	100



Cable/Conduit

Conduit Clamps with Bolts

Features

- Retained bolt and built-in nut means there are less parts to handle or drop. Bright zinc finish
- Combo Head bolt ready to work with any tool handy - Slotted, Hex, #3 Phillips and #2 Robertson
- Mounting hole size CD0 thru CD3 for 1/4" bolt. CD4 thru CD9 for 5/16" bolt. Available in 3/8" mounting hole for 1/2" - 2" pipe. To order add suffix 37 (i.e. CD2B37)
- Can be used in locations where EMT or rigid conduit is used
- Accommodates 1/2" thru 4" conduit



Part Number	Conduit Size - Rigid (in)	Conduit Size - EMT (in)	Standard Packaging Quantity
CD0B*	1/2	1/2	100
CD1B*	3/4	3/4	100
CD2B*	1	1	100
CD2.5B*	-	1 1/4	100
CD3B*	1 1/4	1 1/2	100
CD4B*	1 1/2	-	50
CD5B*	2	2	50
CD6B	2 1/2	2 1/2	25
CD7B	3	3	25
CD8B	3 1/2	3 1/2	10
CD9B	4	4	10

*Manufactured with retained bolt and built-in nut

Notes: Also available in stainless steel 302. Contact ERICO for price and delivery. To order add suffix SS (ie. CD2B-SS). Stainless do not have nutless feature

CD0B through CD5B are UL & cUL Listed and meet or exceed UL Test Requirements

See Beam/Purlin chapter for Assemblies (BC200 Series)

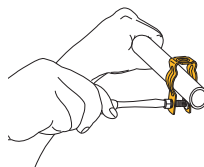

Cable/Conduit

Flange-Mount Conduit Clip

Push-In

Features

- Requires only a hammer to install
- Available for 1/2" thru 1" EMT, rigid, IMT and aluminum conduit
- Available with conduit clip bottom mounted or side mounted
- Will pivot thru 360°



Fig. #1

Part Number	Fig. #	Description	Standard Packaging Quantity
8P24*	1	1/2" conduit to 1/8" to 1/4" flanges	100
8P58*	1	1/2" conduit to 5/16" to 1/2" flanges	100
8P912*	1	1/2" conduit to 9/16" to 3/4" flanges	100
12P24*	1	3/4" conduit to 1/8" to 1/4" flanges	100
12P58*	1	3/4" conduit to 5/16" to 1/2" flanges	100
12P912*	1	3/4" conduit to 9/16" to 3/4" flanges	100
16P24*	1	1" conduit to 1/8" to 1/4" flanges	100
16P58*	1	1" conduit to 5/16" to 1/2" flanges	100
16P912*	1	1" conduit to 9/16" to 3/4" flanges	50
8P24SM†	2	1/2" conduit to 1/8" to 1/4" flanges	100
8P58SM†	2	1/2" conduit to 5/16" to 1/2" flanges	100
8P912SM†	2	1/2" conduit to 9/16" to 3/4" flanges	100
12P24SM†	2	3/4" conduit to 1/8" to 1/4" flanges	100
12P58SM†	2	3/4" conduit to 5/16" to 1/2" flanges	100
12P912SM†	2	3/4" conduit to 9/16" to 3/4" flanges	100
16P24SM†	2	1" conduit to 1/8" to 1/4" flanges	100
16P58SM†	2	1" conduit to 5/16" to 1/2" flanges	100
16P912SM†	2	1" conduit to 9/16" to 3/4" flanges	50

*Load Limit: 25 lbs (ultimate load)

†Load Limit: 15 lbs (ultimate load)

Notes: When using rigid conduit on P series, use next size larger clip (1/2" Rigid use 12P). 'SM' suffix designates 'Sidemount' application

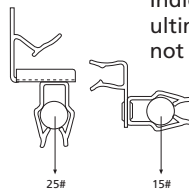

Fig. #2



Flange-Mount Conduit Clip

Snap Close

Features

- Available with conduit clip bottom mounted or side mounted
- Available for 1/2" thru 1" EMT, rigid and aluminum conduit
- Requires only a hammer to install
- Will pivot thru 360°



Fig. #1

Part Number	Fig. #	Description	Standard Packaging Quantity
6M24*	1	3/8" MC/AC cable to 1/8" to 1/4" flanges	100
6M58*	1	3/8" MC/AC cable to 5/16" to 1/2" flanges	100
6M912*	1	3/8" MC/AC cable to 9/16" to 3/4" flanges	100
812M24*	1	1/2" or 3/4" Hammer-On Pipe Clip for Flanges 1/8" to 1/4"	100
812M58*	1	1/2" or 3/4" Hammer-On Pipe Clip for Flanges 5/16" to 1/2"	100
812M912*	1	1/2" or 3/4" Hammer-On Pipe Clip for Flanges 9/16" to 3/4"	100
16M24*	1	1" Hammer-On Pipe Clip for Flanges 1/8" to 1/4"	100
16M58*	1	1" Hammer-On Pipe Clip for Flanges 5/16" to 1/2"	100
16M912*	1	1" Hammer-On Pipe Clip for Flanges 9/16" to 3/4"	100
20M24*	1	1-1/4" Hammer-On Pipe Clip for Flanges 1/8" to 1/4"	100
20M58*	1	1-1/4" Hammer-On Pipe Clip for Flanges 5/16" to 1/2"	100
20M912*	1	1-1/4" Hammer-On Pipe Clip for Flanges 9/16" to 3/4"	50
24M24*	1	1-1/2" Hammer-On Pipe Clip for Flanges 1/8" to 1/4"	50
24M58*	1	1-1/2" Hammer-On Pipe Clip for Flanges 5/16" to 1/2"	50
24M912*	1	1-1/2" Hammer-On Pipe Clip for Flanges 9/16" to 3/4"	50
32M24*	1	2" Hammer-On Pipe Clip for Flanges 1/8" to 1/4"	50
32M58*	1	2" Hammer-On Pipe Clip for Flanges 5/16" to 1/2"	50
32M912*	1	2" Hammer-On Pipe Clip for Flanges 9/16" to 3/4"	50



Cable/Conduit



Fig. #2

Part Number	Fig. #	Description	Standard Packaging Quantity
6M24SM†	2	3/8" MC/AC cable to 1/8" to 1/4" flanges (Sidemount)	100
6M58SM†	2	3/8" MC/AC cable to 5/16" to 1/2" flanges (Sidemount)	100
6M912SM†	2	3/8" MC/AC cable to 9/16" to 3/4" flanges (Sidemount)	100
812M24SM†	2	1/2" to 3/4" conduit to 1/8" to 1/4" flanges (Sidemount)	100
812M58SM†	2	1/2" to 3/4" conduit to 5/16" to 1/2" flanges (Sidemount)	100
812M912SM†	2	1/2" to 3/4" conduit to 9/16" to 3/4" flanges (Sidemount)	100
16M24SM†	2	1" conduit to 1/8" to 1/4" flanges (Sidemount)	100
16M58SM†	2	1" conduit to 5/16" to 1/2" flanges (Sidemount)	100
16M912SM†	2	1" conduit to 9/16" to 3/4" flanges (Sidemount)	100
20M24SM†	2	1 1/4" conduit to 1/8" to 1/4" flanges (Sidemount)	100
20M58SM†	2	1 1/4" conduit to 5/16" to 1/2" flanges (Sidemount)	100
20M912SM†	2	1 1/4" conduit to 9/16" to 3/4" flanges (Sidemount)	50
24M24SM†	2	1 1/2" conduit to 1/8" to 1/4" flanges (Sidemount)	50
24M58SM†	2	1 1/2" conduit to 5/16" to 1/2" flanges (Sidemount)	50
24M912SM†	2	1 1/2" conduit to 9/16" to 3/4" flanges (Sidemount)	50
32M24SM†	2	2" conduit to 1/8" to 1/4" flanges (Sidemount)	50
32M58SM†	2	2" conduit to 5/16" to 1/2" flanges (Sidemount)	50
32M912SM†	2	2" conduit to 9/16" to 3/4" flanges (Sidemount)	50

*Load Limit: 75 lbs (static)

†Load Limit: 25 lbs (static)

Cable/Conduit

Conduit Hangers

From Flange, Wire or Plain Rod

Features

- Supports conduit (EMT, Rigid, ENT, IMT, MC/AC and Aluminum) to rods* or flanges
- Can also be used for: flexible metallic tubing, armored cable, portable cables, control tubes, communications cable, etc
- No installation tools required



Fig. #1

CONDUIT SIZE	#10 & #12 WIRE	#8 & #9 WIRE	3/16" & 1/4" ROD*	1/8"-1/4" FLANGE	5/16"-3/8" FLANGE	7/16"-1/2" FLANGE
1/2" EMT	K8	K8	K8	K8	K12	K12
1/2" RIGID	K8	K12	K12	K12	K12	K16
3/4" EMT	K12	K12	K12	K12	K16	K16
3/4" RIGID	K12	K12	K16	K16	K20**	K20**
1" EMT	—	K16	K16	K16	K20**	K20**
1" RIGID	—	—	—	K20**	K20**	K20**
1 1/4" EMT	—	K20	K20	K20	—	—

**K Series packaged 100 per box. KX - No load rating - positioning only

CABLE SIZE	WIRE SIZES		Standard Packing Quantity
	#12	#10, #9, #8	
14-2 (.433-.475 O.D.)	KX	KX	100
14-3 (.453-.500 O.D.)	KX	KX	100
12-2(.467-.510 O.D.)	KX	KX	100
12-3 (.489-.535 O.D.)	KX	K8	100



Cable/Conduit



Fig. #2

The original "Bat Wings" in 1959

Part Number	Fig. #	Description	Standard Packaging Quantity
KX	1	Conduit hanger MC/AC or BX to #8 wire	100
K8	2	Conduit hanger 1/2" EMT to 1/4" and smaller rods or flanges	100
K12	2	Conduit hanger 3/4" EMT to 1/4" and smaller rods or flanges	100
K16	2	Conduit hanger 1" EMT to 1/4" and smaller rods or flanges	100
K20	2	Conduit hanger 1-1/4" EMT to 1/4" and smaller rods or flanges	100

Notes: May require dedicated drop wire/rod and EC311 – Consult local authority

For horizontal application only when using plain rods.

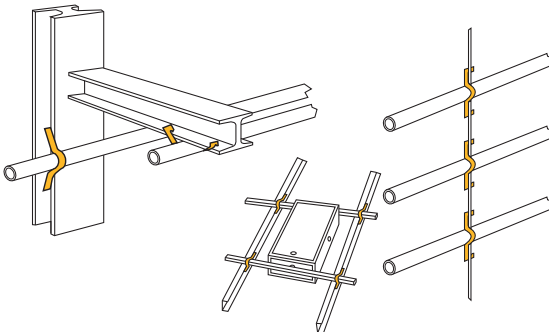

Static Load
25 lbs.

Static Load
100 lbs.

Static Load
50 lbs.

Cable/Conduit

Cable/Conduit From Drop Wire Support

Features

- Supports cable and conduit without bending drop wire
- Faster installation than traditional methods



Fig. #1

Ultimate Load: 25 lbs.

Part Number	Fig. #	Description	Standard Packaging Quantity
PCS1	1	Flexible cable support from #8-#12 drop wire for MC/AC 14-2 through 12-3 with ground up to .600 O.D.	100
PCS2	2	Conduit/cable support from #8-#12 drop wire for 1/2" and 3/4" EMT, MC/AC up to .900 O.D.	100

Notes: NEC 300.11 requires dedicated drop wire/rod and EC311



Fig. #2



Cable/Conduit

Multi-Function Clip

From Drop Wire, Plain Threaded Rod, or Flange

Features

- Attaches to #12 wire thru 3/8" rod
- Fits 1/8" to 3/8" flanges
- Provides attachment of conduit and boxes
- Supports #10-24 and 1/4-20 threaded bridle rings
- Supports 4" or 4-11/16" electrical box



Fig. #1



Part Number	Fig. #	Description	Wire/Rod Size (in)
4Z34	1	Multi-function clip	#12 wire - 1/4"
4Z45	2	Multi-function clip with 1/4-20 stud and hex nut	#12 wire - 1/4"
4Z34812M	3	Multi-plus 1/2" or 3/4" conduit	#12 wire - 1/4"
4Z3416M	3	Multi-plus 1" conduit	#12 wire - 1/4"
4Z348P*	4	Multi-plus 1/2" EMT conduit	#12 wire - 1/4"
4Z3412P*	4	Multi-plus 3/4" EMT conduit	#12 wire - 1/4"
4Z3416P*	4	Multi-plus 1" EMT conduit	#12 wire - 1/4"
6Z34	1	Multi-function clip	3/8" rod
6Z45	2	Multi-function clip	3/8" rod
6Z34812M	3	Multi-plus 1/2" or 3/4" conduit	3/8" rod
6Z3416M	3	Multi-plus 1" conduit	3/8" rod
6Z348P*	4	Multi-plus 1/2" EMT conduit	3/8" rod
6Z3412P*	4	Multi-plus 3/4" EMT conduit	3/8" rod
6Z3416P*	4	Multi-plus 1" EMT conduit	3/8" rod

*When using rigid conduit on P-Series, use next size larger clip (1/2" Rigid use 12P)

Standard Packaging Quantity: 100

Notes: NEC 300.11 requires dedicated drop wire/rod and EC311

When using rigid conduit on P series, use next size larger clip (1/2" Rigid use 12P)

4Z series designates 1/8"-3/8" Flange Size

6Z series designates 3/8"-7/16" Flange Size



Fig. #2



Fig. #3



Fig. #4

Cable/Conduit

Conduit to Conduit

Features

- Available for conduit 1/2" to 1" EMT and 1/2" to 3/4" Rigid
- Ideal as spacer between same or different size conduit
- No tools required for installation
- Top conduit to be used for support only, not a raceway



Ultimate Load: 25 lbs

Part Number	Description	Conduit Size (in)	Standard Packaging Quantity
8P8P	1/2" Conduit to 1/2" conduit	1/2 to 1/2	100
8P12P	1/2" Conduit to 3/4" conduit	1/2 to 3/4	100
8P16P	1/2" Conduit to 1" conduit	1/2 to 1	50
12P12P	3/4"-3/4" Conduit to conduit	3/4 to 3/4	100
12P16P	3/4"-1" Conduit to conduit	3/4 to 1	100
16P16P	1" Conduit to 1" conduit	1 to 1	50

Notes: When using rigid conduit on P series, use next size larger clip (1/2" Rigid use 12P).

Lightweight Trapeze

Features

- Fast, easy assembly for lightweight loads up to 100 lbs
- Use with 3/8" MC/AC to 2" conduit
- No screws or bolts required



Part Number	Description	Load Limit (lbs)	Standard Packaging Quantity
166M	14-2 thru 12-3 MC/AC to 1" Conduit	100	100
16812M	1/2" or 3/4" Conduit to 1" Conduit	100	100
1616M	1" Conduit to 1" Conduit	100	100
1620M	1 1/4" Conduit to 1" Conduit	100	50
1624M	1 1/2" Conduit to 1" Conduit	100	50
1632M	2" Conduit to 1" Conduit	100	50

Notes: Total load of trapeze must not exceed 100 lbs.

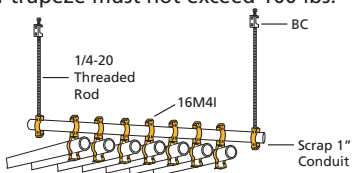

Cable/Conduit

One-Piece Strut Clamp

SCH Series

Features

- One-piece installation – no screws or bolts to drop
- Installs quickly and easily. Requires only a screwdriver or nut driver for installation
- Heavy-duty construction with a bright zinc finish
- Size 3/8" MC/AC to 4" EMT conduit
- All sizes available with load distribution plate attached to screw
- Surface finish: electro zinc plated



Fig. #2



Part Number	Fig. #	EMT (in)	Rigid (in)	Cable OD (in)	Static Load (lbs)	Standard Packaging Quantity
SCH8	1	1/2	-	-	200	100
SCH12	1	3/4	1/2	-	200	100
SCH16	1	1	3/4	-	200	100
SCH20	1	1 1/4	1	-	200	100
SCH6B	2	3/8	-	0.100 - 0.630	200	100
SCH8B	2	1/2	-	0.340 - 0.710	200	100
SCH12B	2	3/4	1/2	0.570 - 0.920	200	100
SCH16B	2	1	3/4	0.720 - 1.160	200	100
SCH20B	2	1 1/4	1	1.000 - 1.510	200	100
SCH24B	2	1 1/2	1 1/4	1.250 - 1.750	350	50
SCH32B	2	2	1 1/2	1.740 - 2.200	350	50
SCH40B	3	-	2	2.000 - 2.380	350	25
SCH48B	3	2 1/2	2 1/2	2.380 - 2.880	350	25
SCH56B	3	3	3	2.720 - 3.500	350	25
SCH64B	3	3 1/2	3 1/2	3.250 - 4.000	350	10
SCH72B	3	4	4	3.850 - 4.500	350	10



Fig. #1



Fig. #3



Cable/Conduit

Universal One-Piece Strut Clamp

SK Series

Features

- One-piece construction
- Retained bolt and built-in nut prevents dropping of loose parts
- One size fits EMT and Rigid
- Installs with screwdriver, standard wrench or nut driver
- Break in half and install
- Bright zinc finish
- Works with standard 1 5/8" Strut



Fig. #1



Fig. #2

Part Number	Fig. #	EMT Rigid (in)	Standard Packaging Quantity
Mild Steel - Static Load 200 lbs			
SK125I	1	3/4	100
SK165I	1	1	100
SK205I	1	1 1/4	100
SK245I	1	1 1/2	50
SK325I	1	2	50
SK85I	1	1/2	100
Mild Steel - Static Load 350 lbs			
SK405I	2	2 1/2	50
SK485I	2	3	50
SK565I	2	3 1/2	25
SK645I	2	4	25
Aluminum - Static Load 150 lbs			
SK12ALA*	1	3/4	100
SK16ALA*	1	1	100
SK20ALA*	1	1 1/4	100
SK24ALA*	1	1 1/2	50
SK32ALA*	1	2	50
SK8ALA*	1	1/2	100
Aluminum - Static Load 200 lbs			
SK40ALA*	2	2 1/2	50
SK48ALA*	2	3	50
SK56ALA*	2	3 1/2	25
SK64ALA*	2	4	25



*Aluminum SKs do not have a thread impression. An aluminum nut and bolt are provided. Order with no "A" on end for standard steel bolt and nut.



Rigid Pipe Clamp One-Piece



Features

- Supports rigid pipe to strut
- Handles heavy loads
- One -piece design incorporates a retained bolt and built-in nut
- Installs with either a screwdriver or a nut driver
- Complete line is available to fit a wide range of pipe sizes
- Available in various materials and finishes

Part Number	Pipe Size (in)		Static Load (lbs)	Standard Packaging Quantity
	Nominal	O.D.		
RIGD0050XX	1/2	0.840	400	100
RIGD0075XX	3/4	1.050	400	100
RIGD0100XX	1	1.315	600	100
RIGD0125XX	1 3/4	1.660	600	50
RIGD0150XX	1 1/2	1.900	800	50
RIGD0200XX	2	2 3/8	800	50
RIGD0250XX	2 1/2	2 7/8	800	25
RIGD0300XX	3	3 1/2	800	25
RIGD0350XX	3 1/2	4	1,000	25
RIGD0400XX	4	4 1/2	1,000	25

Notes: XX denotes finish available:

EG - Electro-Galvanized, CG - Yellow Chromate,
S4 - Stainless 304, S6 - Stainless 316,
HD - Hot Dip Galvanized, AL - Aluminum.



Cable/Conduit

Snap-In Support

MC/AC Cable Flexible Conduit

Features

- Manufactured with stabilizer legs for virtually “wobble-free” support
- One fastener for cable size 14-4, 12-4, 12-3, 12-2, 10-3, 10-2
- Snaps into place on metal stud and beam flange up to 1/8” thick. No tools required for installation
- MAC2 snaps in half to accommodate single run of cable effectively making two clips from one
- Pre-punched holes in clip allow it to be screwed to wood stud, concrete or block
- Delivers compliance for: NEC® Article 300.4(d) allowing cable to be positioned a minimum of 11/4” from face of stud. CEC Rule 12-618 for support of MC/AC cable
- Factory riveted assemblies are available for installation on flange, purlin, acoustical tee, drop wire, concrete, block or wood and metal stud



Fig. #1



Part Number	Fig. #	Description	Standard Packaging Quantity
Runs of MC/AC: 1 to 4			
MAC2T	1	1 to 4 runs for metal stud	100
Runs of MC/AC: 1 to 2			
MAC2	2	Metal or wood stud and up to 1/8” flange	100
MAC2ATA	3	Acoustical Tee	100
MAC2BC	4	1/8” thru 1/2” flange	100
MAC224SM	5	1/8” thru 1/4” flange	100
MAC258SM	5	5/16” thru 1/2” flange	100
MAC2912SM	5	1/16” thru 3/4” flange	100
MAC2VF14	6	1/16” thru 1/4” C purlin or vertical flange	100
MAC2123	7	Z Purlin	100
MAC2AO	8	Offset bracket	100
MAC224	9	1/8” thru 1/4” flange – bottom mount rotates 360°	100
MAC258	9	5/16” thru 1/2” flange – bottom mount rotates 360°	100
MAC2912	9	1/2” thru 3/4” flange – bottom mount rotates 360°	100
MAC24Z34	10	#12 thru 1/4” wire, plain or threaded rod & 1/8” thru 3/8” flange	100
MAC26Z34	10	3/8” plain or threaded rod and 3/8” thru 9/16” flange	100
MAC2FB	11	Through metal stud	100



Notes: Assemblies allow for support from most main and substructures.

Cable/Conduit



Fig. #2



Fig. #3



Fig. #4



Fig. #5



Fig. #6



Fig. #7



Fig. #8



Fig. #9



Fig. #10



Fig. #11



Non-Metallic Sheathed Cable Clip

RMX SERIES



Fig. #1

Features

- Supports non-metallic cable
- When used in combination with other CADDY® Fasteners, RMX can be installed on main or substructures, drop wire and acoustical tee

Part Number	Fig. #	Cable Size	Description	Standard Packaging Quantity
RMX	1	14-2 and 12-2 w/ Ground Wire	Clip for Non-Metallic Sheathed Cable	100
RMXDH2	2	14-2 and 12-2 w/ Ground Wire	Non-Metallic Sheathed Cable to Deck	100
RMXAB	3	14-2 and 12-2 w/ Ground Wire	Non-Metallic Sheathed Cable to Angle Bracket	100
RMXAO	4	14-2 and 12-2 w/ Ground Wire	Non-Metallic Sheathed Cable to Offset Bracket	100
RMXVF14	5	14-2 and 12-2 w/ Ground Wire	Non-Metallic Sheathed Cable to C Purlin 1/16" to 1/4" Thick	100
RMXAF14	6	14-2 and 12-2 w/ Ground Wire	Non-Metallic Sheathed Cable to Z Purlin 1/16" to 1/4" Thick	100
RMXBC	7	14-2 and 12-2 w/ Ground Wire	Non-Metallic Sheathed Cable to Beam thru 1/2 Flange	100
RMX4Z34	8	14-2 and 12-2 w/ Ground Wire	Non-Metallic Sheathed Cable to #12 Wire thru 1/4" Plain Rod or Beam 1/8" thru 3/8" Flange	100
RMX6Z34	8	14-2 and 12-2 w/ Ground Wire	Non-Metallic Sheathed Cable 3/8" Plain or Threaded Rod 3/8" thru 7/16" Flange	100
RMXATS	9	14-2 and 12-2 w/ Ground Wire	Non-Metallic Sheathed Cable to Acoustical "Tee-Bar"	100
RMX24	10	1/8"-1/4" Thick Flange	14-2 and 12-2 with Ground Wire; Non-Metallic Sheathed Cable to Beam	100
RMX58	10	5/16"-1/2" Thick Flange	14-2 and 12-2 with Ground Wire; Non-Metallic Sheathed Cable to Beam	100
RMX912	10	9/16"-3/4" Thick Flange	14-2 and 12-2 with Ground Wire; Non-Metallic Sheathed Cable to Beam	100

Notes: Not for use in Canada on NMC wire or power application; Assemblies allow support from most main and substructures



Cable/Conduit

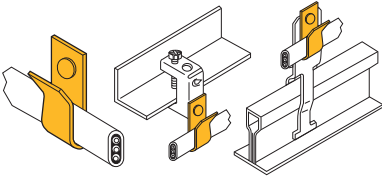

Assemblies allow support from most main and substructures



Fig. #2



Fig. #3



Fig. #4



Fig. #5



Fig. #6



Fig. #7



Fig. #8



Fig. #9



Fig. #10

Cable/Conduit

Combination Box/ Conduit Hangers From Drop Wire/ Rod And Beam

B18 Series



Fig. #1

Features

- One riveted assembly
- No conduit bends (beam application)
- 66% less Drop Wires (rod/wire application)
- Delivers with NEC® & CEC compliance



Fig. #2



Fig. #3

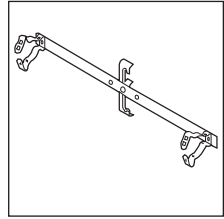

Fig. #4

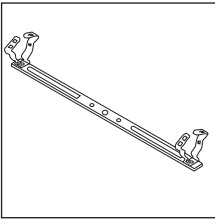

Fig. #5

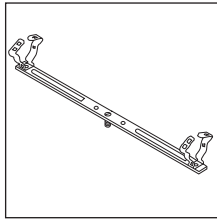

Fig. #6



Fig. #7



Cable/Conduit

Part Number	Fig. #	Description	Standard Packaging Quantity
B18SBT18	1	Box & Conduit Support - Mounts a 4" square box with multiple conduit mounting plate	25
B18SBT184Z	2	Box & Conduit Support - Mounts electrical box with multiple conduit mounting plate and 4Z34	25
812MB18	3	Mounts 4" sq. boxes with 1/2" & 3/4" conduit from #12 wire thru 1/4" rod	25
812MB186	4	Mounts 4" sq. boxes with 1/2" & 3/4" conduit from #12 wire thru 1/4" rod	25
16MB18	4	Mounts 4" sq. boxes with 1" conduit from #12 wire thru 1/4" rod	25
16MB186	4	Mounts 4" sq. boxes with 1" conduit to 3/8" plain or threaded rod	25
6MB18	4	Mounts 4" sq. boxes with MC, AC cable from #12 wire thru 1/4" flange	25
6MB186	4	Mounts 4" sq. boxes with MC, AC cable 3/8" plain or threaded rod	25
812MB18A	5	1/2" or 3/4" Conduit plain center hole for screw or threaded rod mount	25
16MB18A	5	Mounts 4" sq. boxes with 1" conduit plain center hole for screw or threaded rod mount	25
6MB18A	5	Mounts 4" sq. boxes with MC, AC cable plain center hole for screw or threaded rod mount	25
812MB18S	6	Mounts 4" sq. boxes with 1/2" & 3/4" conduit with 1/4-20 x 9/16" stud in center hole	25
812MB1824	7	Mounts 4" sq. boxes with 1/2" & 3/4" conduit to 1/8" thru 1/4" flange	25
812MB1858	7	Mounts 4" sq. boxes with 1/2" & 3/4" conduit to 5/16" thru 1/2" flange	25
16MB1824	7	Mounts 4" sq. boxes with 1" conduit to 1/8" thru 1/4" flange	25
16MB1858	7	Mounts 4" sq. boxes with 1" conduit to 5/16" thru 1/2" flange	25
6MB1824	7	Mounts 4" sq. boxes with MC, AC cable 1/8" thru 1/4" flange	25
6MB1858	7	Mounts 4" sq. boxes with MC, AC cable 5/16" thru 1/2" flange	25

Add "CO" at the end of the part number, for factory riveted assembly for multiple conduit clips. Includes mounting plate and center conduit clips pre-riveted (additional conduit clips ordered separately).

Notes: NEC 300.11 requires dedicated drop wire/rod and EC311. For single and multiple runs of conduit. cUL®us Listed Box and Conduit Support



Cable/Conduit

Standoff Decking Fasteners

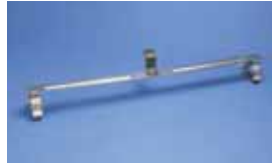

Fig. #1

Part Number	Fig. #	Description	Standard Packaging Quantity
6MB18CPNAM	1	Mounts 4" sq. boxes with MC/AC cable with CPNAM	25
16MB18CPNAM	1	Mounts 4" sq. boxes with 1" conduit with CPNAM	25
812MB18CPNAM	1	Mounts 4" sq. boxes with 1/2" or 3/4" conduit with CPNAM	25
6MB18TDH	2	Mounts 4" sq. boxes with MC/AC cable with TDH	25
16MB18TDH	2	Mounts 4" sq. boxes with 1" conduit with TDH	25
812MB18TDH	2	Mounts 4" sq. boxes with 1/2" or 3/4" conduit with TDH	25
6MCPNAM	3	Conduit clip for 14-2 thru 12-3 MC/AC, and 3/8 flexible conduit with CPNAM	50
16MCPNAM	3	Conduit clip for 1" conduit with CPNAM	50
20MCPNAM	3	Conduit clip for 1-1/4" conduit with CPNAM	50
24MCPNAM	3	Conduit clip for 1-1/2" conduit with CPNAM	50
812MCPNAM	3	Conduit clip for 1/2" - 3/4" conduit with CPNAM	50
6MTDH	4	Conduit clip for 14-2 thru 12-3 MC/AC, and 3/8 flexible conduit with TDH	50
16MTDH	4	Conduit clip for 1" conduit with TDH	50
20MTDH	4	Conduit clip for 1-1/4" conduit with TDH	50
24MTDH	4	Conduit clip for 1-1/2" conduit with TDH	50
812MTDH	4	Conduit clip for 1/2" - 3/4" conduit with TDH	50
B18SBT18CPNAM	5	Box & Conduit Support - Mounts a 4" sq. box, multiple conduit mounting plate with CPNAM	25
B18SBT18TDH	6	Box & Conduit Support - Mounts a 4" square box with multiple conduit mounting plate	25
CD0BCPNAM	7	1/2" EMT or RIGID Conduit Clamp with retained bolt, built in nut with CPNAM	50
CD1BCPNAM	7	3/4" Pipe Clip with retained bolt, built-in nut with CPNAM	50
CD2BCPNAM	7	1" EMT or RIGID Conduit Clamp with retained bolt, built-in nut with CPNAM	50
CD2.5BCPNAM	7	1-1/4" EMT Conduit Clamp with retained bolt, built-in nut with CPNAM	50
CD0BTDH	8	1/2" EMT or RIGID Conduit Clamp with retained bolt, built in nut with TDH	50
CD1BTDH	8	3/4" Pipe Clip with retained bolt, built-in nut with TDH	50
CD2BTDH	8	1" EMT or RIGID Conduit Clamp with retained bolt, built-in nut with TDH	50
CD2.5BTDH	8	1-1/4" EMT Conduit Clamp with retained bolt, built-in nut with TDH	50
CPNAM	9	Decking Angle Bracket	100
SBT18TDH	10	Multi-Run, Conduit Hanger Plate with TDH	50
TDH	11	3/8" Plain Hole	50



Cable/Conduit

Features

- Meets the requirements of NEC Section 300.4(E)
- Supports conduit 1-1/2" (38 mm) under the roof decking to prevent potential damage from nails or screws
- Attach to deck using TDH deck hanger or the CPNAM angle bracket
- For use with 14-2 thru 12-3 MC/AC, 3/8 flexible conduit and 1/2" to 1-1/2" EMT

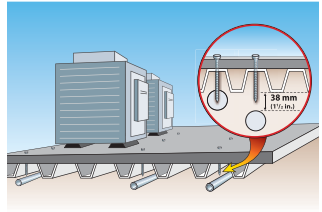

Roof Decking Thickness				
IN	mm	Gauge	Lbs.	kN.
0.025-0.0276	0.63-0.70	24	130	0.60
0.0276-0.0315	0.70-0.80	23	150	0.70
0.0315-0.0394	0.80-1.00	22	180	0.80
0.0394	1.00	19	200	0.90
0.0516	1.20	18	240	1.07



Fig. #2



Fig. #3



Fig. #4



Fig. #5



Fig. #6



Fig. #7



Fig. #8



Fig. #9



Fig. #10



Fig. #11

Cable/Conduit

Cable Snap Clip

Features

- Supports cable from 1/16" - 1/2" flange
- Works effectively with MC and AC cable dimensions 3/8" - 1 1/4" and low voltage cables from 7/32" and up
- Clip "snaps" on flange and cable "snaps" into clip.



Part Number	Cable O.D. (in)	Description	Standard Packaging Quantity
SC2A	0.218 - 0.281	Low voltage, data and MC/AC cable to 1/16" thru 3/16" flange thickness	100
SC2B	0.312 - 0.375		100
SC2C	0.375 - 0.437		100
SC2D	0.468 - 0.562		100
SC2E	0.500 - 0.718		100
SC2F	0.750 - 0.937		100
SC2G	0.968 - 1.250		100
SC4A	0.218 - 0.281	Low voltage, data and MC/AC cable to 3/16" thru 9/32" flange thickness	100
SC4B	0.312 - 0.375		100
SC4C	0.375 - 0.437		100
SC4D	0.468 - 0.562		100
SC4E	0.500 - 0.718		100
SC4F	0.750 - 0.937		100
SC4G	0.968 - 1.250		100
SC8A	0.218 - 0.281	Low voltage, data and MC/AC cable to 5/16" thru 1/2" flange thickness	100
SC8B	0.312 - 0.375		100
SC8C	0.375 - 0.437		100
SC8D	0.468 - 0.562		100
SC8E	0.500 - 0.718		100
SC8F	0.750 - 0.937		100
SC8G	0.968 - 1.250		100

Notes: No load rating - positioning only



Cable/Conduit

MC/AC Cable To Metal Stud

Features

- Easily attaches MC or AC to metal stud
- No tools required for installation
- Provides fast installation



Part Number	Cable Size	Standard Packaging Quantity
449	12-2 (.467-.510 O.D.)	100
	12-3 (.489-.535 O.D.)	
	14-2 (.433-.475 O.D.)	
	14-3 (.453-.500 O.D.)	

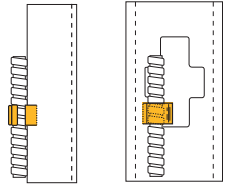

Flexible Conduit and Cable Hanger

Features

- Bundle runs* of MC or AC. (*Refer to local authorities and NEC® Article 310 for derating ampacity when flexible power cables are used)
- Can be used with 4H series flange clips, DH2 / TDH deck clips, AO or AB nail brackets, VF14 vertical flange, AF14/122/123 Z purlin



Part Number	Description	Runs of MC/AC	Ultimate Load (lbs)	Standard Packaging Quantity
WMX3	Cable hanger - 1 1/8" diameter	3	50	100
WMX6	Cable hanger - 1 3/4" diameter	6	75	100

Notes: Ultimate load limit 75 lbs. - WMX6, 50 lbs. - WMX3



Cable/Conduit

Support Bracket for MC/AC Cable MCS Series

Features

- Neatly isolates, supports and secures MC/AC cables
- Properly spaces MC/AC cable to help eliminate bundling and NEC® & CEC derating issues
- Results in a “neat and workmanlike” installation
- Reduces inventory
- Holds up to eight MC/AC cables



Fig. #1



Part Number	Fig. #	Description	Standard Packaging Quantity
Pre-Riveted Factory Assemblies for MCS50			
MCS50*	1	MC/AC cable support spacer for up to 4 runs	50
MCS5024	2	To beams 1/8"-1/4" flange thickness (Hammer-On)	25
MCS504Z	3	To #12 wire thru 1/4" plain or threaded rod	25
MCS5058	2	To beams 5/16"-1/2" flange thickness (Hammer-On)	25
MCS506Z	3	To 3/8" plain or threaded rod	25
MCS50912	2	To beams 9/16"-3/4" flange thickness (Hammer-On)	25
MCS50AF14	4	Z Purlin	25
MCS50BC	5	To beams thru 1/2" flange thickness (Screw-On)	25
MCS50BC200	6	To beams 1/8"-5/8" flange thickness (Screw-On)	25
MCS50VF14	7	C Purlin or Open Bar Joist	25
Pre-Riveted Factory Assemblies for MCS100			
MCS100*	8	Support bracket #12/14 AC up to 8 cables	50
MCS10024	2	To beams 1/8"-1/4" flange thickness (Hammer-On)	25
MCS1004Z	3	To #12 wire thru 1/4" plain or threaded rod	25
MCS10058	2	To beams 5/16"-1/2" flange thickness (Hammer-On)	25
MCS1006Z	3	To 3/8" plain or threaded rod	25
MCS100912	2	To beams 9/16"-3/4" flange thickness (Hammer-On)	25
MCS100AF14	4	Z Purlin	25
MCS100BC	5	To beams thru 1/2" flange thickness (Screw-On)	25
MCS100BC200	6	To beams 1/8"-5/8" flange thickness (Screw-On)	25
MCS100VF14	7	C Purlin or Open Bar Joist	25
Pre-Riveted Factory Assemblies for MCS101			
MCS101†	9	MC/AC cable† support spacer for up to 7 runs	50
MCS10124	2	To beams 1/8"-1/4" flange thickness (Hammer-On)	25
MCS1014Z	3	To #12 wire thru 1/4" plain or threaded rod	25
MCS10158	2	To beams 5/16"-1/2" flange thickness (Hammer-On)	25
MCS1016Z	3	To 3/8" plain or threaded rod	25
MCS101912	2	To beams 9/16"-3/4" flange thickness (Hammer-On)	25
MCS101AF14	4	Z Purlin	25
MCS101BC	5	To beams thru 1/2" flange thickness (Screw-On)	25
MCS101BC200	6	To beams 1/8"-5/8" flange thickness (Screw-On)	25
MCS101VF14	7	C Purlin or Open Bar Joist	25

*Nominal outside diameters from .430 thru .560. 14-3, 14-4, 12-2, 12-4 and 10-2 MC/AC Cable

†Nominal outside diameters from .560 thru .690. Standard MC sizes: 10/3, 10/4, *8/2, *8/3. Super Neutral Cable: 12/3, 12/4 and *10/2. Isolated Ground: 12/3, 12/4, 10/2, 10/3, 10/4 and 8/2.



Cable/Conduit



Fig. #2



Fig. #3



Fig. #4



Fig. #5



Fig. #6



Fig. #7



Fig. #8



Fig. #9



Multiple Conduit Mounting Plate

SBT18

Features

- Single point structure attachment and easy "snap-in" field assembly of up to three conduit clips
- No tools necessary for installation of clips
- Helps eliminate conduit bends for 1/2" and 3/4" sizes
- Available in a variety of riveted assemblies
- Helps eliminate multiple beam clamps or strut assemblies
- Helps guide alignment with standard 1/2" electrical box knockouts and mounting holes



Fig. #1

Part Number	Fig. #	Description	Load Rating Per Tab (lbs)	Standard Packaging Quantity
SBT18	1	Multi-Run, Conduit Hanger Plate	50	50
SBT1824	2	Hammer-on; underside 1/8"-1/4" flange	25	50
SBT1858	2	Hammer-on; underside 5/16"-1/2" flange	25	50
SBT18912	2	Hammer-on; underside 9/16"-3/4" flange	25	50
SBT1824SM	3	Hammer-on; side mount 1/8"-1/4" flange	50	50
SBT1858SM	3	Hammer-on; side mount 5/16"-1/2" flange	50	50
SBT18912SM	3	Hammer-on; side mount 9/16"-3/4" flange	50	50
SBT184Z34	4	Multi-function clip #12 wire thru 1/4" plain rod	15	50
SBT186Z34	4	Multi-function clip 3/8" plain or threaded rod	15	50
SBT18BC	5	Beam clamp thru 1/2" flange	25	50
SBT18BC200	6	Beam clamp 1/8" to 5/8" flanges	33	50



Cable/Conduit



Fig. #2



Fig. #3



Fig. #4



Fig. #5



Fig. #6



Washer Wing Nut

Features

- No tools required for installation



Part Number	Description	Static Load	Stud Length	Standard Packaging Quantity
4WN	1/4-20 thread impression washer wing nut	-	-	100

Note: 4WN: Not to exceed the load rating of the corresponding fastener

Hammer-On Plain and Threaded Rod Hangers

Beam Clamps

Features

- Requires only a hammer to install
- Used to suspend #8 wire, 1/4", 3/8" plain rod or 1/4" or 3/8" threaded rod from beam flanges 1/8" to 3/4" thick



Static Load: 200 lbs

Part Number	Flange Thickness (in)	Rod Size	Standard Packaging Quantity
4TI58	5/16 to 1/2	1/4-20	100
6TI24	1/8 to 1/4	3/8-16	100
6TI58	5/16 to 1/2	3/8-16	100
6TI912	9/16 to 3/4	3/8-16	100



Cable/Conduit

CADDY® PYRAMID ST Series

Fixed Strut Supports

Features

- Provide fixed-height mounting platform 4" or 6" off the roof surface and 10" or 16" of usable strut length
- Static load is up to 1,500 lbs
- Hot-dip galvanized finish provides superior corrosion protection



Fig. #1



Fig. #2

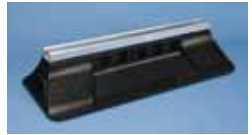

Fig. #3



Fig. #4

Part Number	Fig. #	H (in)	L1 (in)	L2 (in)	W (in)	Surface Area (in ²)	Weight lbs / ea.	Static Load (lbs)*
RPS360400	1	4	10	12.5	8	94.3	2.95	1000
RPS360401	2	6	10	12.5	8	94.3	4.65	1000
RPS360403	3	4	16	18.5	8	140.8	4.40	1500
RPS360404	4	6	16	18.5	8	140.8	7.05	1500

* Max. recommended load at 10.6 psi roof loading. Contact project or roofing engineer for maximum allowable load on individual project roof system.

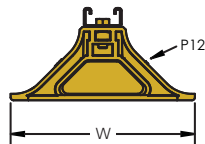
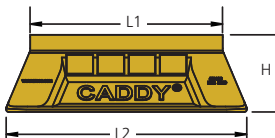

Cable/Conduit

CADDY® PYRAMID ST Series

Adjustable-Height Strut Supports

Features

- Allow elevation change up to 16" off the roof surface with up to 10" or 16" of usable strut length
- Static load is up to 1,500 lbs
- Hot-dip galvanized finish provides superior corrosion protection

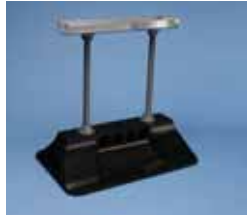

Fig. #1



Fig. #2

Part Number	Fig. #	H1 (in)	Max H2 (in)	L1 (in)	L2 (in)	W (in)	Surface Area (in ²)	Weight lbs / ea.	Static Load (lbs)*
RPS360402	1	4.6	12	10	12.5	8	94.3	4.30	1000
RPS360405	2	5.5	17	16	18.5	8	140.8	6.00	1500

* Max. recommended load at 10.6 psi roof loading. Contact project or roofing engineer for maximum allowable load on individual project roof system.

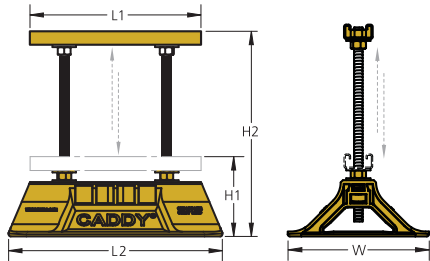

Cable/Conduit

CADDY® PYRAMID RL Series

Fixed Roller Supports

Features

- Provides roller capability for up to 6" nominal pipe with 5.5" fixed height
- Polymeric rollers will not rust, helping to ensure long-lasting performance and smooth roller action
- Hot-dip galvanized finish on steel roller axle, fittings and other hardware provides superior corrosion protection
- Supports up to 6" diameter (Nom.) Sch. 40 water-filled steel pipe at maximum spacing of 10'

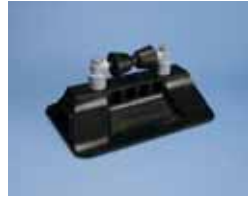

Fig. #1



Fig. #2

Part Number	Fig. #	Nominal Pipe Ø (in)	H (in)	L (in)	W (in)	Surface Area (in ²)	Weight lbs / ea.	Max. Nom. Pipe Size (in)* Ø
RPS360406	1	3/4 - 3	5.5	12.5	8	94.3	3.85	3
RPS360408	2	2 - 6	5.5	18.5	8	140.8	5.20	6

* Maximum diameter of Sch. 40 water-filled steel pipe at maximum 10' support spacing.

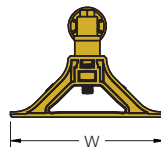
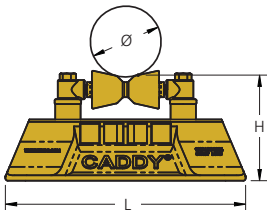

Cable/Conduit

CADDY® PYRAMID RL Series

Adjustable-Height Roller Supports

Features

- Can accommodate elevation changes of up to 16" off the roof with up to 6" diameter (Nom.) pipe
- Polymeric rollers will not rust, helping to ensure long-lasting performance and smooth roller action
- Hot-dip galvanized finish on steel roller axle, fittings and other hardware provides superior corrosion protection
- Supports up to 6" diameter (Nom.) Sch. 40 water-filled steel pipe at maximum spacing of 10'



Fig. #1



Fig. #2

Part Number	Fig. #	Nom. Pipe Ø (in)	H1 (in)	Max. H2 (in)	L (in)	W (in)	Surface Area (in ²)	Weight lbs / ea.	Max. Nom. Pipe Size (in)* Ø
RPS360407	1	3/4 - 3	5.5	12	12.5	8	94.3	4.20	3
RPS360409	2	2 - 6	5.5	16	18.5	8	140.8	5.95	6

* Maximum diameter of Sch. 40 water-filled steel pipe at maximum 10' support spacing.

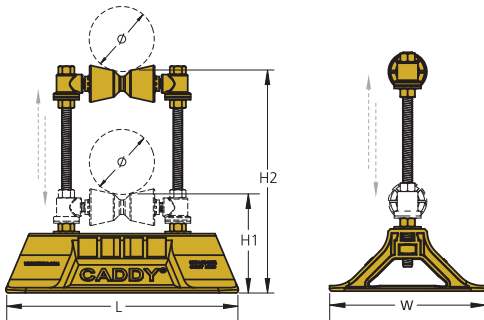

Cable/Conduit

CADDY® PYRAMID EZ Series

Adjustable-Height Tool-Free Rooftop Pipe Supports



Fig. #1

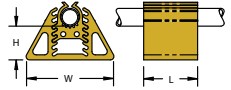

Features

- Quick and easy: No tools or fasteners needed; fast snap-on installation
- Roof friendly: Made of UV-stabilized EPDM material
- Height adjustable: Multiple models allow for height adjustment from 1-3/4" to 4", 4" to 6", or 5" to 7"
- Convenient: Models can accommodate all pipe and conduit types up to 2" Sch. 40

Part Number	Fig. #	Max. Nom. Pipe or Conduit Size (in)*	Max. Pipe or Conduit OD (in)	H (in)	L (in)	W (in)	Weight lbs / ea.	Ultimate Load (lbs)**
RPSE1H24	1	1	1.315	1 3/4 - 4	4	6	2	170
RPSE1H57	2	1	1.315	5 - 7	4	6	3.04	170
RPSE2H46	3	2	2.370	4 - 6	4	6	3.30	250
RPSE4H46	-	4	4.500	4 - 6	4	9.5	5.14	400

* Maximum diameter of Sch. 40 water-filled steel pipe at maximum 10' support spacing.

** Ultimate load at 1/4" deflection. Contact project or roofing engineer for maximum allowable load on individual project roof system.



Fig. #2

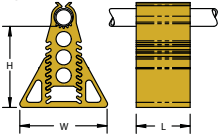
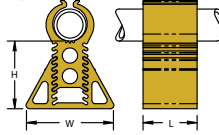

Fig. #3



Cable/Conduit

CADDY® PYRAMID ST & RL Series Accessories

Part Number	Fig. #	Description	Standard Packaging Quantity
RPS360410	1	Rubber mat for CADDY® PYRAMID ST and RL Series, 9" X 13.5"	10
RPS360411	1	Rubber mat for CADDY® PYRAMID ST and RL Series, 9" X 19.5"	10
RPS360412	2	Retainer strap for CADDY® PYRAMID RL Series, up to 3"	25
RPS360413	3	Retainer strap for CADDY® PYRAMID RL Series, 3.5" - 6"	25
RPSCSEG	4	CADDY® PYRAMID Column Support, EG	1
P110000EG	5	Post Base for A Channel	5
P110000HD	5	Strut Post Base P11	25



Fig. #1



Fig. #2



Cable/Conduit



Fig. #3



Fig. #4



Fig. #5



Cable/Conduit

CADDY® PYRAMID 25

Pipe & Equipment Supports

Features

- Supports up to 25 lb static loads
- Lightweight, all-plastic construction weighs less than 0,15 kg
- Has a small – 4" x 5" footprint
- UV-resistant, designed and tested for outdoor use
- Handles up to three 1/2" (21,3 mm) or two 3/4" (26,9 mm) or one 1" (33,7 mm) pipes/conduit
- No tools or fasteners needed for installation
- Helps protect the roof membrane

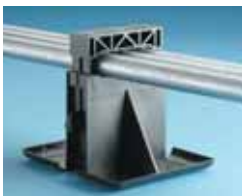

Part Number	Max. Static Load (lbs)	Height (in)
PPRPS25H4	25	3 5/8
PPRPS25H6	25	5 5/8

CADDY® PYRAMID 50

Pipe & Equipment Supports

Features

- Supports up to 50 lb static loads
- Polyethylene closed-cell foam and 1,5 mm steel construction.
- The 4" high model has a 10-3/8" x 4" footprint
- The 6" high model has a 10-3/8" x 4-3/4" footprint
- Electro-galvanized (EG) finish on the rooftop version and grey polyester coating on the plenum version provide superior corrosion protection
- Metal top designed to shed water and minimize water collection on foam base
- Helps protect the roof membrane

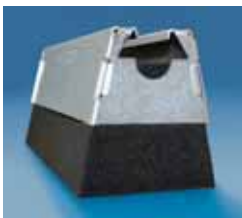

Part Number	Max. Static Load (lbs)	Height (in)	Surface Finish
RPS50AHSV	50	2 1/4	Polyester
RPS50H4EG	50	4	EG
RPS50H6EG	50	6	EG



Cable/Conduit

CADDY® PYRAMID 150

Pipe & Equipment Supports

Features

- Supports up to 150 lb static loads
- Has six 3/8"-16 threaded inserts with captive nuts that allows the product to be used with standard pipe clamps and accessories
- Large 16" x 12" footprint distributes load more evenly than alternative methods
- Polyethylene closed-cell foam and 14-gauge steel construction
- Electro-galvanized (EG) finish on top plate for added corrosion protection
- Helps protect the roof membrane



Part Number	Max. Static Load (lbs)	Height (in)	Thread Size	Surface Finish	With Strut
RPS150T1	150	3 3/16	3/8-16	EG	No
RPS150T2	150	4	3/8-16	EG	Yes

CADDY® PYRAMID 300

Pipe & Equipment Supports

Features

- Dramatically reduces installation time by replacing labor-intensive methods for supporting pipes and conduits
- Supports multiple runs of pipe and conduit on roofs and below raised floors
- Supports concentrated static loads up to 300 lbs
- Absorbs shock and vibration
- Protects roof membrane
- Metal cover protects from weather and other environmental conditions
- Features an electro-galvanized finish for corrosion protection



Part Number	Max. Static Load (lbs)	Height (in)	Thread Size	Surface Finish	With Strut
RPS300T1	300	3 3/16	3/8-16	EG	No
RPS300T2	300	4	3/8-16	EG	Yes

Cable/Conduit

CADDY® PYRAMID 600

Pipe & Equipment Supports

Features

- Consists of two CADDY® PYRAMID 300 bases tied together with a length of strut
- Footprint is 32" x 12" (24" x 16" optional with cutting of strut) for more even load distribution
- Supports up to 600 lb static loads
- Helps to protect the roof membrane



Part Number	Max. Static Load (lbs)	Height (in)	Thread Size	Surface Finish	With Strut
RPS600T2	600	4	3/8-16	EG	Yes



Cable/Conduit

CADDY® PYRAMID RPS H-Frame Series

Features

- Designed to offer superior protection to rooftop membrane
- Highly engineered design of the base uniformly distributes load
- Continuous bottom surface mitigates unwanted stress concentrations
- Ideal for pipework, duct, conduit, cable tray, or any combination of these
- Base is made from recycled, UV stabilized engineered thermoplastic
- Integral foam pad provides gentle interface for all roof types
- Accepts standard strut channels, 1-5/8" x 1-5/8"
- Mounting hardware pre-installed in bases
- Hot-dip galvanized hardware
- Hardware kit includes 6 bolts, 6 strut nuts, and 2 L-brackets to complete H-frame

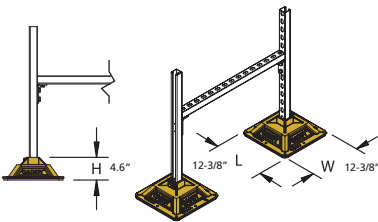

Fig. #1

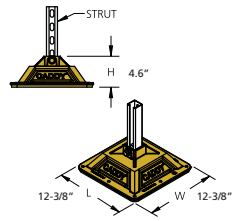

Fig. #2

Part Number	Fig. #	Description	Static Load lbs	Standard Packaging Quantity
RPS360420	1	RPS H-Frame Kit, 12x12 in, Foam, Hardware Kit Included	1500	1
RPS360421	1	RPS H-Frame Kit, 12x12 in, Rubber, Hardware Kit Included	1500	1
RPS360422	2	RPS Post Base, 12x12 in, Foam	750	1
RPS360423	2	RPS Post Base, 12x12 in, Rubber	750	1

NOTES: Maximum static load represents 750 lbs (3,335 N) per foot.

The end user must select and evaluate the strut framing to ensure the assembled H-Frame can properly support the applied load.

Cable/Conduit

Metal Deck Conduit Support

Features

- Provides spacing between conduit and deck surface
- Easily attached with screw gun or power tool
- Permits conduit to be laid out and then attached
- Eliminates offset bending conduit



Part Number	Description	Standard Packaging Quantity
AOL8P	Support bracket for 1/2" EMT	100
AOL12P	Support bracket for 3/4" EMT or 1/2" Rigid	100
AOL16P	Support bracket for 1" EMT or 3/4" Rigid	100

Notes: No Load Rating - Positioning Only

Nail Bracket

Features

- Used to attach conduit to wood, steel or concrete
- Eliminates the need for offset bends
- Works with power tools, screw guns or nails
- May be attached after positioning conduit



Part Number	Description	Standard Packaging Quantity
CNB812M	Nail Bracket, M-Series 1/2" & 3/4" Conduit	100
CNB8P	Nail Bracket, P-Series for 1/2" EMT	100
CNB12P	Nail Bracket, P-Series for 3/4" EMT or 1/2" Rigid	100

Notes: No Load Rating - Positioning Only



Beam/Purlin



Beam/Purlin

CADDY® ROD LOCK Beam Clamp

Features

- Works with slightly damaged threads and minor burrs on the threaded rod
- Reduces installation time up to 60%
- Load capacity up to 500 lbs- depending on flange thickness
- UL® 203 & UL 2239 Listed
- FM® Approved

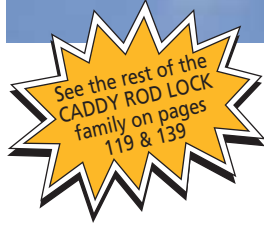

Part Number	Description	Standard Packaging Quantity
CRLB37EG	3/8" CADDY® ROD LOCK Beam Clamp	100

Notes:

1. Load Rating for flanges 1/8"-5/16" is 250 lbs and for flanges 3/8"-7/16" is 500 lbs.
2. CRLB37EG Beam Clamp is FM Approved when installed in the bottom mount orientation.
3. CRLB37EG Beam Clamp is UL Listed for fire sprinkler applications when a lock nut is installed on the threaded rod on the bottom side of the beam clamp.
4. For use on plain and electro-galvanized (EG) hardware only

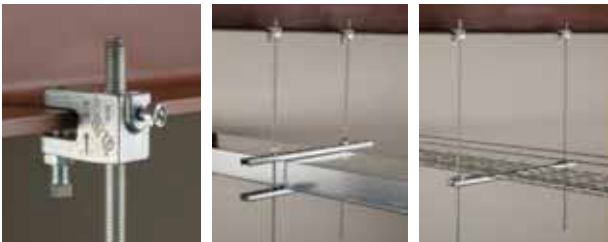
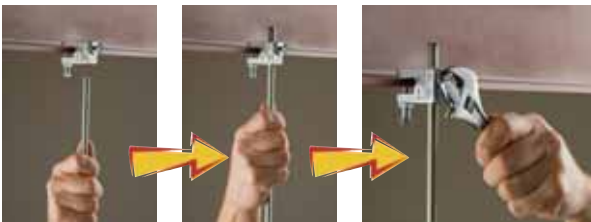

Beam/Purlin

Hammer-On Flange Clip

Features

- Provides a “portable” 1/4” hole
- Fits most beams and bulb tees
- Installs with just a hammer



Part Number	Flange Thickness (in)	Standard Packaging Quantity	Static Load (lbs)
2H4	3/32 to 9/64	100	160
4H24	1/8 to 1/4	100	200
4H58	5/16 to 1/2	100	200
4H912	9/16 to 3/4	100	200



See CADDY® SPEED LINK in the Hangers/Hanging Systems chapter for more information

Beam/Purlin

Spring Steel Beam Clamps

Features

- Eliminates offset bending conduit
- BCISN375 has built-in smart nut which snaps directly onto 3/8" -16 threaded rod, is adjustable and removable, and eliminates extensive "threading" into place
- Easy installation to beam flanges up to 1/2"
- Accommodates standard 1/4"-20 or #10-24 threaded bridle rings
- Supports 1/4" and 3/8" threaded rod, S-hooks, electrical boxes, conduit and bridle rings



Fig. #1

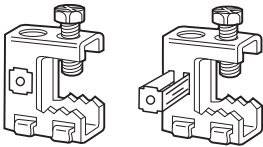

Fig. #2

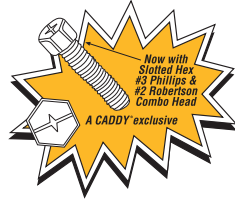

Fig. #3



Fig. #4



Fig. #5



Fig. #6



Beam/Purlin

Part Number	Fig. #	Description	Static Load (lbs)	Standard Packaging Quantity
BC	1	Beam clamp through 1/2" flange	100	100
BCISN375	2	Beam clamp through 1/2" flange with 3/8-16 Smart Nut	100	100
BC812M	3	1/2" or 3/4" conduit to beam through 1/2" flange	100	100
BC16M	3	1" conduit to beam through 1/2" flange	100	100
BC20M	3	1 1/4" conduit to beam through 1/2" flange	100	100
BC24M	3	1 1/2" conduit to beam through 1/2" flange	100	50
BC32M	3	2" conduit to beam through 1/2" flange	100	50
BC812MSM	4	1/2" or 3/4" conduit to beam through 1/2" flange, side mount	25	100
BC16MSM	4	1" conduit to beam through 1/2" flange, side mount	25	100
BC20MSM	4	1 1/4" conduit to beam through 1/2" flange, side mount	25	100
BC24MSM	4	1 1/2" conduit to beam through 1/2" flange, side mount	25	50
BC32MSM	4	2" conduit to beam through 1/2" flange, side mount	25	50
BC8P	5	1/2" conduit to beam through 1/2" flange	25*	100
BC12P	5	3/4" conduit to beam through 1/2" flange	25*	100
BC16P	5	1" conduit to beam through 1/2" flange	25*	100
BC8PSM	6	1/2" conduit to beam through 1/2" flange, side mount	15*	100
BC12PSM	6	3/4" conduit to beam through 1/2" flange, side mount	15*	100
BC16PSM	6	1" conduit to beam through 1/2" flange, side mount	15*	100

*Ultimate static load limit.

Notes: When using rigid conduit on P-Series, use next size larger clip (1/2" Rigid use 12P).

Beam/Purlin

Beam Clamps

Features

- Easy installation to beam flanges up to 1/2"
- Supports 1/4" threaded rod, 1/4" threaded bridle rings and boxes
- Available riveted to conduit clips 1/2" to 2"
- Bright zinc finish
- Eliminates offset bending conduit



Fig. #1

Static Load (lbs): 100

Part Number	Fig. #	Rigid (in)	EMT (in)	Standard Packaging Quantity
BC200	1	-	-	50
BC200CD0B	2	1/2	1/2	50
BC200CD1B	2	3/4	3/4	50
BC200CD2.5B	2	-	1 1/4	50
BC200CD2B	2	1	1	50
BC200CD3B	2	1 1/4	1 1/2	50
BC200CD4B	2	1 1/2	-	25
BC200CD5B	2	2	2	25

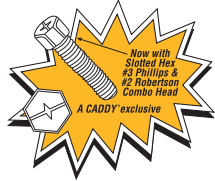

Fig. #2

Notes: Threaded hole on back and bottom. See Misc. Components section for threaded bridle rings.

Big Beam Clamp

Features

- Ideal for electrical, mechanical, and HVAC applications



Static Load (lbs): 200

Part Number	Description	Standard Packaging Quantity
BC400	For 3/8-16 threaded rod or 3/8-16 bolts to beam flange through 3/4"	25



Beam/Purlin

Hammer-On Plain and Threaded Rod Hangers

Beam Clamps

Features

- Requires only a hammer to install
- Used to suspend #8 wire, 1/4", 3/8" plain rod or 1/4" or 3/8" threaded rod from beam flanges 1/8" to 3/4" thick



Fig. #1

Static Load: 200 lbs

Part Number	Fig. #	Flange Thickness (in)	Rod Size	Standard Packaging Quantity
70824	1	1/8 to 1/4	#8 wire or 1/4" Plain Rod	100
70858	1	5/16 to 1/2	#8 wire or 1/4" Plain Rod	100
708912	1	9/16 to 3/4	#8 wire or 1/4" Plain Rod	100
6A24	2	1/8 to 1/4	3/8" (Plain)	100
6A58	2	5/16 to 1/2	3/8" (Plain)	100
6A912	2	9/16 to 3/4	3/8" (Plain)	100
4TI24	3	1/8 to 1/4	1/4-20	100
4TI58	3	5/16 to 1/2	1/4-20	100
4TI912	3	9/16 to 3/4	1/4-20	100
6TI24	3	1/8 to 1/4	3/8-16	100
6TI58	3	5/16 to 1/2	3/8-16	100
6TI912	3	9/16 to 3/4	3/8-16	100
6TA24	3	1/8 to 1/4	1/4-20 or 3/8-16 Threaded*	100
6TA58	3	5/16 to 1/2	1/4-20 or 3/8-16 Threaded*	100
6TA912	3	9/16 to 3/4	1/4-20 or 3/8-16 Threaded*	100

*Nuts required.



Fig. #2



Fig. #3



Beam/Purlin

Hammer-On Flange Clip - Universal

Features

- When used with a CADDY® brand combination conduit hanger, the conduit run lines up with “knock-outs” in outlet box and eliminates offsets and bends
- Provided with a 1/4-20 thread impression so that the box may be quickly and securely attached to the clamp
- Also available with a staked stud, 1/4-20 x 3/8” to provide easier attachment of outlet boxes to beams.
- Eliminates having to use loose screws
- The combination washer-wing nut (Part No. 4WN) can be used to attach box (not included)
- Allows for use with cable ties
- 1/4-20 x 3/8” screws P/N S3575BP50 available as separate item

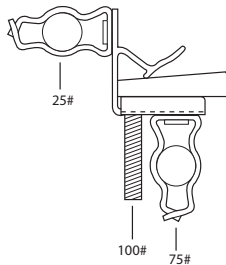

Fig. #1

Part Number	Fig. #	Flange Thickness (in)	Standard Packaging Quantity
M24	1	1/8 to 1/4	100
M58	1	5/16 to 1/2	100
M912	1	9/16 to 3/4	100
M24S	2	1/8 to 1/4	100
M58S	2	5/16 to 1/2	100
M912S	2	9/16 to 3/4	100



Fig. #2



Indicated loads are static load limits and should not be combined.



Beam/Purlin

"C" Purlin Clips - Vertical

Features

- One fastener fits flanges 1/16" to 1/4"
- Supports wire or rod from bar joist and C-Purlin
- Installs from floor with VAFT tool and conduit



Fig. #1

Static Load (lbs): 160

Part Number	Fig. #	Description	Standard Packaging Quantity
VF14	1	Universal attachment to 1/16" to 1/4" angle flange	100
VF14708	2	#8 wire or 1/4" plain rod to 1/16" to 1/4" thick vertical flange	100
VF146A	2	3/8" plain rod to 1/16" to 1/4" thick vertical flange	100
VF144TI	3	1/4-20 threaded rod to 1/16" to 1/4" thick vertical flange	100
VF146TI	3	3/8-16 threaded rod to 1/16" to 1/4" thick vertical flange	100
VF146T	3	1/4-20 or 3/8-16 threaded rod to 1/16" to 1/4" thick vertical flange (nuts required)	100

Notes: Installation tool VAFT.



Fig. #2



Fig. #3



Installation tool for VF & AF assemblies



Part Number	Description	Standard Packaging Quantity
VAFT	Installation tool for VF & AF assemblies (1/2" conduit not included)	1

Beam/Purlin

"Z" Purlin Clips - Angular

Features

- One fastener fits flanges 1/16" to 1/4"
- Supports wire or rod from bar joist and "Z"-Purlin
- Installs from floor with VAFT tool and conduit



Fig. #1

Static Load (lbs): 100

Part Number	Fig. #	Description	Standard Packaging Quantity
AF14	1	Universal attachment to 1/16" to 1/4" vertical flange	100
AF14708	2	#8 wire or 1/4" plain rod to 1/16" to 1/4" thick angle flange	100
AF146A	2	3/8" plain rod to 1/16" to 1/4" thick angle flange	100
AF144TI	3	1/4-20 threaded rod to 1/16" to 1/4" thick angle flange	100
AF146TI	4	3/8-16 threaded rod to 1/16" to 1/4" thick angle flange	100
AF146T	3	1/4-20 or 3/8-16 threaded rod to 1/16" to 1/4" thick angle flange (nuts required)	100

Notes: Installation tool VAFT.



Fig. #2



Fig. #3



Fig. #4



Beam/Purlin

"Z" Purlin Clips

Features

- Hammer-on clip compensates for angle of purlin
- Provides method for attaching conduit and boxes to purlin



Fig. #1

Part Number	Fig. #	Description	Standard Packaging Quantity
122	1	1/4" hole to Z purlin	100
123	2	1/4" bottom hole to Z purlin	100
122708	3	For #8 wire or 1/4" plain rod to Z purlin	100
1226A	3	For 3/8" plain rod to Z purlin	100
1224TI	4	For 1/4" threaded rod to Z purlin	100
1226TI	4	For 3/8" threaded rod to Z purlin	100
1226T	4	For 1/4" and 3/8" threaded rod to Z purlin, nuts required	100
1236M	5	For 3/8" conduit to Z purlin	100
123812M	5	For 1/2" to 3/4" conduit to Z purlin	100
1238P*	6	For 1/2" conduit to Z purlin	100
12312P*	6	For 3/4" conduit to Z purlin	100
12316M	5	For 1" conduit to Z purlin	100
12316P*	6	For 1" conduit to Z purlin	50
12320M	5	For 1 1/4" conduit to Z purlin	50

*When using rigid conduit on P series, use next size larger clip (1/2" Rigid use 12P).

Notes: Loads indicated are for CADDY® Fasteners only.

Purlin thickness 13 to 16 gage.

Static load limit 100 lbs except for P Series which is 25 lbs ultimate static load limit.



Fig. #2



Fig. #3



Fig. #4



Fig. #5



Fig. #6



Beam/Purlin

Multi-Flange Rod Hanger

Features

- "C" or "Z" Purlins or up to 1/4" (7 mm) horizontal beam flanges
- Slotted, Hex, Robertson, Phillips combo head bolt
- Hardened cup point setscrew for secure grip
- Fast installation of threaded components
- Integrated thread eliminates need for nuts
- Structural attachment to bottom of purlins and beams to support threaded rod
- Swivel feature option
- Electro-galvanized finish for corrosion protection



Fig. #1



Part Number	Fig. #	Description	Thread Size (in)	Standard Packaging Quantity
PH4	1	Multi-Flange Beam Clamp for 1/4" Rod	1/4-20	25
PH6	1	Multi-Flange Beam Clamp for 3/8" Rod	3/8-16	25
PHSW4	2	Multi-Flange Beam Clamp with Swivel for 1/4-20 Rod	1/4-20	25
PHSW6	2	Multi-Flange Beam Clamp with Swivel for 3/8-16 Rod	3/8-16	25

Notes: Torque wrenches are generally not used or available on many job sites, the setscrew should be tightened so it contacts the beam and then an additional 1/4 to 1/2 turn added.

Loads up to 200 lbs (0.90 kN) on C or Z purlins or 160 lbs (0.71 kN) on horizontal beams.



Fig. #2



Beam/Purlin

Retainer Strap Assemblies

Features

- Only one piece to install
- Fast hammer-on installation
- Riveted retainer strap replaces cumbersome assemblies and hardware
- Retainer strap is easily bent into position
- Lightweight design, heavyweight results



Fig. #1

Part Number	Fig. #	Description	Load Limit (lbs)
CM245	1	1/8"-1/4" Flange - 1/4-20 x 3/8" Stud	75
CM585	1	5/16" - 1/2" Flange - 1/4-20 x 3/8 Stud	75
CM912S	1	9/16" - 3/4" Flange - 1/4-20 x 3/8 Stud	75
C4TI24	2	1/8" - 1/4" Flange - 1/4-20 Threaded Rod	200
C4TI58	2	5/16" - 1/2" Flange - 1/4-20 Threaded Rod	200
C4TI912	2	9/16" - 3/4" Flange - 1/4-20 Threaded Rod	200
C6TI24	2	1/8" - 1/4" Flange - 3/8-16 Threaded Rod	200
C6TI58	2	5/16" - 1/2" Flange - 3/8-16 Threaded Rod	200
C6TI912	2	9/16" - 3/4" Flange - 3/8-16 Threaded Rod	200
CM24812M	3	1/8" - 1/4" Flange - 1/2" & 3/4" Conduit	75
CM2416M	3	1/8" - 1/4" Flange - 1" Conduit	75
CM58812M	3	5/16" - 1/4" - 1/2" & 3/4" Conduit	75
CM5816M	3	5/16" - 1/4" - 1" Conduit	75
CM912812M	3	9/16" - 3/4" - 1/2 & 3/4 Conduit	75
CM91216M	3	9/16" - 3/4" - 1 Conduit	75
C24812SM	4	1/8" - 1/4" Flange - 1/2" - 3/4" Conduit	25
C2416SM	4	1/8" - 1/4" Flange - 1" Conduit	25
C58812SM	4	5/16" - 1/4" Flange - 1/2" - 3/4" Conduit	25
C5816SM	4	5/16" - 1/2" Flange - 1 Conduit	25
C912812SM	4	9/16" - 3/4" Flange - 1/2" - 3/4" Conduit	25
C91216SM	4	9/16" - 3/4" Flange - 1 Conduit	25

Standard Packaging Quantity: 50



Fig. #2



Fig. #3



Fig. #4



Bulb Tee Clip

Features

- Provides means of support from underside of bulb tee 1-1/2" to 2-3/8" wide
- Ceiling material not defaced when correctly applied
- Requires only a hammer to install
- Eliminates offset bending conduit



Fig. #1

Part Number	Fig. #	Description	Standard Packaging Quantity
4J2438	1	Jr. Beam Clamp for bulb tees - Use standard 1/4" carriage bolt (not included)	100
4NJ2438*	2	Jr. Beam Clamp for bulb tee with 3/8" long 1/4-20, nut included	100
6NJ2438*	2	Jr. Beam Clamp for bulb tees - 3/8-16 nut included	100
4J2438S	2	Jr. Beam Clamp for bulb tees - 1/4-20, stud included	100

*Nut included

Notes: Other stud lengths quoted on request.
Will support 135 lbs static load limit from a 1-1/2" wide flange.



Fig. #2



Beam/Purlin

Wide Mouth Beam Clamps Models BC13/BC14



Fig. #1

Features

- BC13 Heavy-duty steel beam clamp to fit up to 7/8" (22 mm) thick flanges
- BC14 Heavy-duty steel beam clamp to fit flanges from 5/8" (16 mm) to 15/8" (41 mm) thick
- Hardened cup point setscrew to provide secure grip on tapered sections
- Electro-galvanized finish for corrosion protection
- Retaining strap available separately, for more secure attachment for industrial applications (see BC09 Series)
- Threaded to allow quick and easy attachment of threaded rod or bolted components

Part Number	Fig. #	Rod Size	Bolt Size	Flange Thickness (Max) (in)	Standard Packaging Quantity	Load Capacity (lbs)
BC130025EG	1	1/4-20	3/8-16	7/8	20	650
BC130037EG	1	3/8-16	3/8-16	7/8	20	650
BC130050EG	1	1/2-13	1/2-13	7/8	10	1,100
BC130062EG	1	5/8-11	1/2-13	7/8	10	1,600
BC140037EG	2	3/8-16	3/8-16	1 5/8	20	800
BC140050EG	2	1/2-13	1/2-13	1 5/8	20	1,300
BC140062EG	2	5/8-11	1/2-13	1 5/8	10	1,900

Minimum flange thickness 5/8" (16 mm).

Notes: Torque wrenches are generally not used or available on many job sites, the setscrew should be tightened so it contacts the beam and then an additional 1/4 to 1/2 turn added.

Setscrew must be tightened and torqued onto the sloped side of the I-beam.

Retaining strap available separately, for more secure attachment.



Fig. #2



Reversible Beam Clamps Model 300 & 310

Features

- Conforms with Federal Specification WW-H-171 (Type 23), Manufacturers Standardization Society ANSI®/MSS-SP-58 (Type 19 & 23), install in accordance with ANSI/MSS-P-69
- Malleable iron clamp with electro-galvanized finish for enhanced corrosion protection
- Available in hot dip galvanized finish (special order)
- Hardened cup point setscrew to provide secure grip on tapered sections
- Accommodates attachment of 1/4" dia. threaded rod, bridle rings and boxes from three positions – top, bottom and back
- Retaining strap available separately (for Model 300C)
- Reversible for attachment to top or bottom flange



Fig. #1

Part Number	Fig. #	Rod Size	Flange Thickness (in)	Fastener Height (in)	Fastener Width (in)	Standard Packaging Quantity	Bottom Mount Load (lbs)	Top Mount Load (lbs)
3000037EG	1	3/8-16	3/4	1 9/16	13/16	100	250	500
3000050EG	1	1/2-13	3/4	1 13/16	1 1/16	50	760	950
3000062EG	1	5/8"	3/4	1 13/16	1 1/16	50	760	950
3000075EG	1	3/4"	3/4	1 3/4	1 1/8	50	760	950
3100037EG	2	3/8"	1 1/4	2 1/16	13/16	50	250	500
3100050EG	2	1/2"	1 1/4	2 3/8	1 1/16	50	760	950
BC260025EG	3	1/4-20	1/4	-	-	100	100	250

Notes: Safety factor of 3.5. Available in hot dip galvanized finish (special order).

Finish: Electro-zinc plated (EG)



Fig. #2



Fig. #3



Beam/Purlin

Multi-Purpose Purlin Clamp Models 315



Features

- Large mouth opening (15/8" - 41 mm) to fit large thick flange (bottom flange) steel beams or angles and large lip "C" or "Z" Purlins
- Available for threaded rod sizes 3/8" diameter
- Locknut and hardened cup point setscrew to provide secure grip on tapered sections
- Malleable iron clamp with electro-galvanized finish for enhanced corrosion protection
- Available in hot dip galvanized finish (special order)
- Attaches to a wide variety of structural sections including "C" or "Z" Purlins, angles, channels and beams

Part Number	Rod Size	Bolt Size	Flange Thickness (in)	Surface Finish	Standard Packaging Quantity	Rec# Load (lbs)
3150037EG	3/8-16	3/8-16	1	EG	25	400



Beam/Purlin

Beam Clamp With Swivel Option Model BC10



Fig. #1

Features

- For attachment to beams or angles up to 3/4" (20 mm) thick
- Hardened cup point setscrew to provide secure grip on tapered sections
- Stamped steel with electro-galvanized finish for enhanced corrosion protection
- J-Bolt assembly available for more secure attachment in industrial applications
- Designed to allow swivel up to 15° from bottom holes or with the use of BC15 swivel (available separately) for attachment to inclined beams without bending the rod
- Accommodates rod sizes up to 1/2" dia. (max)

Part Number	Fig. #	Rod Size (in)	Flange Thickness (in)	Surface Finish	Standard Packaging Quantity	Max. Rec. Load (lbs)
BC100000EG	1	1/2	3/4	EG	25	300; 500
BC101500EG	2	1/2	3/4	EG	25	500

Note: F1 is the load rating from the front hole (500 lbs); F2 is the load rating from the back hole (300 lbs)



Fig. #2

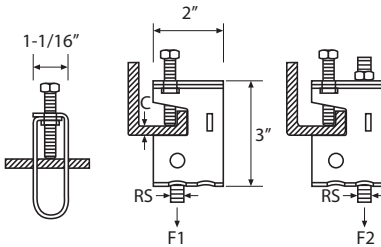

Beam/Purlin

Beam Retainer Accessories

J-Bolt for use with BC10 Beam Clamp

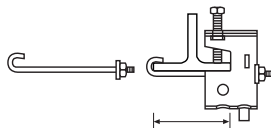

Fig. #1

Part Number	Fig. #	Description
BC110000EG	1	Beam Clamp with 8" J-Bolt
BC120000EG	1	Beam Clamp with 12" J-Bolt



Retainer Straps for use with BC13 and BC14 Beam Clamps



Fig. #2

Part Number	Fig. #	Description	Standard Packaging Quantity	Flange Width (in) [Max]
BC090900EG	2	Anchor Strap 9"	50	6
BC091200EG	2	Anchor Strap 12"	50	9
BC091500EG	2	Anchor Strap 15"	25	12

Beam/Purlin

Rod Hanger Beam Clamp Model 200



Features

- For attachment to beams or angles up to 3/4" (20 mm) thick
- Locknut and hardened cup point setscrew to provide secure grip on tapered sections
- Stamped steel with electro-galvanized finish for enhanced corrosion protection
- Available for 3/8" to 5/8" threaded rod size
- Available in hot dip galvanized finish
- Retaining strap available separately for more secure attachment for industrial applications (for Model 34SL, 300C and 35RS)

Part Number	Rod Size	Bolt Size	Flange Thickness (in)	Height (in)	Width (in)	Standard Packaging Quantity	Rec# Load (lbs)
2000037EG	3/8-16	3/8-16	3/4	2 3/8	2 1/4	100	250

Notes: Safety factor of 5.



Pipe-To-Beam Clamps

Features

- Ideal for direct attachment of RMC or service pipe sections
- Malleable iron casting with steel hardware
- Hot dip galvanized coating for superior corrosion protection
- Range for 3/8" to 4" diameter pipe
- Available with stainless steel hardware (special order)



RA

Part Number	Pipe Size (in)	Rec# Load (lbs)	Standard Packaging Quantity	Qty. Exception
PAR- — RA- 0037HD	3/8	200	25	-
PAR- ET- RA- 0050HD	1/2	250	25	-
PAR- ET- RA- 0075HD	3/4	300	25	-
PAR- ET- RA- 0100HD	1	400	25	-
PAR- ET- RA- 0125HD	1 1/4	400	25	-
PAR- ET- RA- 0150HD	1 1/2	500	20	PAR-25
PAR- ET- RA- 0200HD	2	600	20	-
PAR- ET- RA- 0250HD	2 1/2	700	10	PAR- 10; ET-25; RA-20
PAR- ET- RA- 0300HD	3	800	10	RA-15
PAR- — RA- 0350HD	3 1/2	900	10	-
PAR- — RA- 0400HD	4	1,000	10	-

Notes: C Max is 1/4"/20 mm. Available with stainless steel hardware (special order).



PAR



ET



CADDY® ROD LOCK

Threaded Rod Mounting System

- Features a breakthrough “push-install” design that works with slightly damaged threads and minor burrs on the threaded rod
- Reduces installation time by up to 52%



Strut



CADDY® ERISTRUT Channel



Part Number	Description	Qty. Per
A12AH200GN	12GA Half Slot Welded 1 5/8" 20' Green	200' bundle
A12AH200PG	12GA Half Slot Welded 1 5/8" 20' Pre-Galvanized	200' bundle
A12H1000GN	12GA Half Slot 1 5/8" 10' Green	500' bundle
A12H1000PG	12GA Half Slot 1 5/8" 10' Pre-Galvanized	500' bundle
A12H2000GN	12GA Half Slot 1 5/8" 20' Green	500' bundle
A12H2000PG	12GA Half Slot 1 5/8" 20' Pre-Galvanized	500' bundle
A14H1000GN	14GA Half Slot 1 5/8" 10' Green	500' bundle
A14H1000PG	14GA Half Slot 1 5/8" 10' Pre-Galvanized	500' bundle
A14H2000GN	14GA Half Slot 1 5/8" 20' Green	500' bundle
A14H2000PG	14GA Half Slot 1 5/8" 20' Pre-Galvanized	500' bundle
C12H1000GN	12GA Half Slot 13/16" 10' Green	500' bundle
C12H1000PG	12GA Half Slot 13/16" 10' Pre-Galvanized	500' bundle
C12H2000GN	12GA Half Slot 13/16" 20' Green	500' bundle
C12H2000PG	12GA Half Slot 13/16" 20' Pre-Galvanized	500' bundle
C14H1000GN	14GA Half Slot 13/16" 10' Green	500' bundle
C14H1000PG	14GA Half Slot 13/16" 10' Pre-Galvanized	500' bundle
C14H2000GN	14GA Half Slot 13/16" 20' Green	500' bundle
C14H2000PG	14GA Half Slot 13/16" 20' Pre-Galvanized	500' bundle
CONB122000PG	1 3/8 Continuous Concrete Insert Pre-Galvanized	500' bundle

Model	Width (in)	Height (in)	Gauge
A12	1-5/8	1-5/8	12
A14	1-5/8	1-5/8	14
B12	1-5/8	1-3/8	12
C12	1-5/8	13/16	12
C14	1-5/8	13/16	14

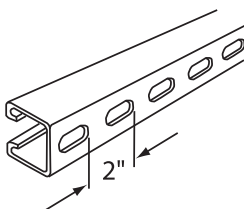

Half Slot (H)
1-1/8" x 9/16" slots
punched on 2" centers



CON
Continuous Concrete Insert



CADDY® ROD LOCK Channel Nut

Features

- Works with slightly damaged threads and minor burrs on the threaded rod
- Reduces installation time up to 34%
- Load capacity up to 750 lbs
- Electro-galvanized ductile iron



Part Number	Description	Max. Recommended Load	Standard Packaging Quantity
CRLS37EG	3/8" CADDY® ROD LOCK Channel Nut	750 lbs	100

- For use on plain and electro-galvanized (EG) hardware only.
- ASTM® A307 Grades A-C, ISO® 898 Grades 4-6.

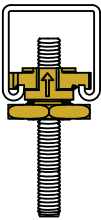

N1
↓

Strut

Strut Nuts



Fig. #1



Fig. #2



Fig. #3



Fig. #4



Fig. #5



Fig. #6



Fig. #7



Fig. #8



Strut

1 5/8" (41 mm) wide

Part Number	Fig. #	Description
MFA4I	1	1/4-20 thread impression
NUT0025EG	2	Strut Nut w/o Spring 1/4"
NUT0031EG	2	Strut Nut w/o Spring 5/16"
NUT0037EG	2	Strut Nut w/o Spring 3/8"
NUT0050EG	2	Strut Nut w/o Spring 1/2"
NUT0062EG	2	Strut Nut w/o Spring 5/8"
NUT0075EG	2	Strut Nut w/o Spring 3/4"
TSNT0025EG	3	Top Spring Nut for 1/4" Channel
TSNT0037EG	3	Top Spring Nut for 3/8" Channel
TSNT0050EG	3	Top Spring Nut for 1/2" Channel

1 5/8" x 1 5/8" (41 mm x 41 mm) or

1 5/8" x 1 3/8" (41 mm x 35 mm)

Part Number	Fig. #	Description
SPRA0037EG	4	Spring Nut for A&B Channel 3/8"
SPRA0050EG	4	Spring Nut for A&B Channel 1/2"

1 5/8" x 13/16" (41 mm x 21 mm)

Part Number	Fig. #	Description
SPRC0025EG	5	Spring Nut for C Channel 1/4"
SPRC0050EG	5	Spring Nut for C Channel 1/2"

1 5/8" x 2 7/16" (41 mm x 62 mm) or

1 5/8" x 3 1/4" (41 mm x 83 mm)

Part Number	Fig. #	Description
SPRD0025EG	6	Spring Nut for D&E Channel 1/4"
SPRD0037EG	6	Spring Nut for D&E Channel 3/8"
SPRD0050EG	6	Spring Nut for D&E Channel 1/2"
SPRD0062EG	6	Spring Nut for D&E Channel 5/8"
SPRD0075EG	6	Spring Nut for D&E Channel 3/4"

Part Number	Fig. #	Description	Stud Length (in)
MFA625	7	1/4-20 x 5/8" stud	5/8
SPRM2508EG	8	Stud Spring Nut 1/4" x 7/8"	7/8
SPRM2511EG	8	Stud Spring Nut 1/4" x 1-1/8"	1 1/8
SPRM3711EG	8	Stud Spring Nut 3/8" x 1-1/8"	1 1/8
SPRM5011EG	8	Stud Spring Nut 1/2" x 1-1/8"	1 1/8
SPRM5013EG	8	Stud Spring Nut 1/2" x 1-3/8"	1 3/8

Strut

CADDY® SLICK NUT

Features

- Eliminates the need for hard-to-handle spring nuts and a washer
- Unique one-piece design installs with one hand
- Provides fast, universal attachment of threaded rod and hardware to standard strut profiles
- Reduces installation time
- Easily fits all standard strut depths – reducing inventory
- For use in indoor environments



Part Number	Thread Size	Recommended Torque (ft lb)	F1 Load (lbs.)		F2 Load (lbs.)		Standard Packaging Quantity
			12 GA	14 GA	12 GA	14 GA	
SLICK250	1/4-20	5	250	150	800	800	100
SLICK375	3/8-16	15	400	300	1,100	1,100	100
SLICK500	1/2-13	20	650	550	1,250	1,100	100

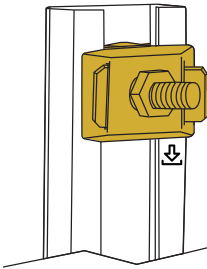

F1 Load

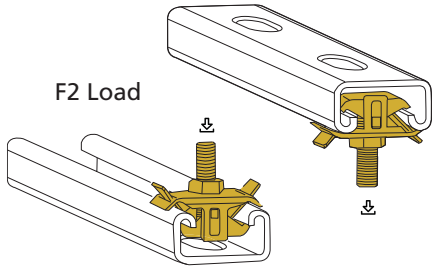

Strut

STS (Strut-to-Strut) Strut Clamp

Features

- Provides fast assembly of back-to-back half-slot strut as an alternative to welded strut
- Unique one-piece assembly that eliminates the need for bolts, washers, and nuts
- For new or retrofit applications
- Allows joining of dissimilar half-slot channel, regardless of profile size or finish
- Easy installation with a 1/2" nut driver
- Can be used on CADDY® ERISTRUT or any half-slot strut with minimal half slot dimensions of 9/16" x 7/8"



Part Number	Description	Load (lbs)	Recommended Torque (ft-lbs)	Standard Packaging Quantity
STS	Strut-to-Strut Clamp	1,000	5	100

Note: 1000 lbs working load per total assembly. Half-slot dimensions vary by manufacturer. Minimum half-slot dimensions 14 mm x 22 mm. Strut type and structure need to be evaluated to establish load for assembly. Use 1 STS per 1 ft. of strut, minimum of 2 required.

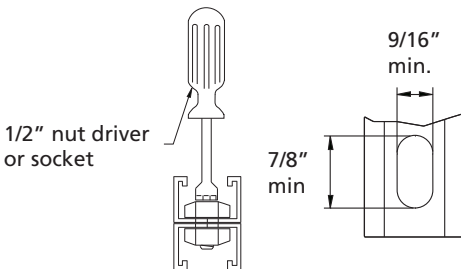

Rigid Pipe Clamp One-Piece



Features

- Supports rigid pipe to strut
- Handles heavy loads
- One -piece design incorporates a retained bolt and built-in nut
- Installs with either a screwdriver or a nut driver
- Complete line is available to fit a wide range of pipe sizes
- Available in various materials and finishes

Part Number	Pipe Size (in)		Load (lbs)	Standard Packaging Quantity
	Nominal	O.D.		
RIGD0050XX	1/2	0.840	400	100
RIGD0075XX	3/4	1.050	400	100
RIGD0100XX	1	1.315	600	100
RIGD0125XX	1 1/4	1.660	600	50
RIGD0150XX	1 1/2	1.900	800	50
RIGD0200XX	2	2 3/8	800	50
RIGD0250XX	2 1/2	2 7/8	800	25
RIGD0300XX	3	3 1/2	800	25
RIGD0350XX	3 1/2	4	1,000	25
RIGD0400XX	4	4 1/2	1,000	25

Notes: XX denotes finish available: EG - Electro-Galvanized, CG - Yellow Chromate, S4 - Stainless 304, S6 - Stainless 316, HD - Hot Dip Galvanized, AL - Aluminum.



Strut

One-Piece Strut Clamp

SCH Series

Features

- One-piece installation
– no screws or bolts to drop
- Installs quickly and easily;
requires only a screwdriver or
nut driver for installation
- Heavy-duty construction with
a bright zinc finish
- Size 3/8" MC/AC to 4" EMT
conduit
- All sizes available with load
distribution plate attached to
screw
- Surface finish: electro zinc plated



Fig. #2



Part Number	Fig. #	EMT (in)	Rigid (in)	Cable OD (in)	Static Load (lbs)	Standard Packaging Quantity
SCH8	1	1/2	-	-	200	100
SCH12	1	3/4	1/2	-	200	100
SCH16	1	1	3/4	-	200	100
SCH20	1	1 1/4	1	-	200	100
SCH6B	2	3/8	-	0.100 - 0.630	200	100
SCH8B	2	1/2	-	0.340 - 0.710	200	100
SCH12B	2	3/4	1/2	0.570 - 0.920	200	100
SCH16B	2	1	3/4	0.720 - 1.160	200	100
SCH20B	2	1 1/4	1	1.000 - 1.510	200	100
SCH24B	2	1 1/2	1 1/4	1.250 - 1.750	350	50
SCH32B	2	2	1 1/2	1.740 - 2.200	350	50
SCH40B	3	-	2	2.000 - 2.380	350	25
SCH48B	3	2 1/2	2 1/2	2.380 - 2.880	350	25
SCH56B	3	3	3	2.720 - 3.500	350	25
SCH64B	3	3 1/2	3 1/2	3.250 - 4.000	350	10
SCH72B	3	4	4	3.850 - 4.500	350	10



Fig. #1



Fig. #3



Strut

Universal One-Piece Strut Clamp

SK Series

Features

- One-piece construction
- Retained bolt and built-in nut prevents dropping of loose parts
- One size fits EMT and Rigid
- Installs with screwdriver, standard wrench or nut driver
- Break in half and install
- Bright zinc finish
- Works with standard Strut

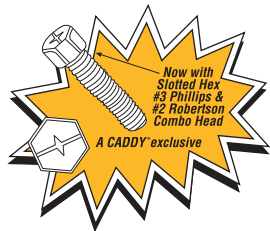

Fig. #1



Fig. #2

Part Number	Fig. #	EMT Rigid (in)	Standard Packaging Quantity
Mild Steel - Static Load 200 lbs.			
SK125I	1	3/4	100
SK165I	1	1	100
SK205I	1	1 1/4	100
SK245I	1	1 1/2	50
SK325I	1	2	50
SK85I	1	1/2	100
Mild Steel - Static Load 350 lbs.			
SK405I	2	2 1/2	50
SK485I	2	3	50
SK565I	2	3 1/2	25
SK645I	2	4	25



Strut

Dual Purpose Strut/ Beam Clamps

Features

- More versatile alternative to window bracket or standard beam clamp
- Supports strut and/or rod
- Lock nut and hardened cup point setscrew provide secure grip on tapered sections
- Permits strut channel opening positioning in any direction



Fig. #1

Part Number	Fig. #	Description	Rod Size	Max. Flange Thickness (in)	Load (lbs)	Standard Packaging Quantity
200RS375	1	Dual Purpose Strut/Beam Clamp 3/8-16	3/8-16	1	250	10
200RS500	2	Dual Purpose Strut/Beam Clamp 1/2-13	1/2-13	1	360	10
STCB6*	3	Dual Purpose Strut/Beam Clamp, Widemouth 3/8-16	3/8-16	2	400	10

*When used as a Strut Beam Clamp, Min-Max flange size is 3/4" - 1 5/8". When used as a beam clamp without strut, Min-Max flange size is 1 1/2" - 2".

Notes: Load rating based on single clamp. When used as strut hanger minimum required is two clamps.



Fig. #2



Fig. #3



Strut

Beam Clamps for Strut

Features

- Structural attachment to beams and columns to support strut
- Fits A and D channels



Fig. #1

Part Number	Fig. #	Description	Bolt Size	Max. Flange Size	Load (lbs)	Standard Packaging Quantity
BC16A000EG	1	Channel to Beam Clamp for A Channel	-	7/8" (22 mm)	740	20
BC17A000EG	2	Channel to Beam Clamp for A Channel	-	3/4" (20 mm)	1,200	25
BC17D000EG	2	Channel to Beam Clamp for D Channel	-	3/4" (20 mm)	1,200	25
BC17PL00EG	2	Plate Only	-	-	-	-
BC180037EG	3	Beam Clamp for Strut	3/8-16	1" (25 mm)	660	25
BC180050EG	3	Beam Clamp for Strut	1/2-13	1" (25 mm)	660	25
BC200000EG	4	1/2" Retainer Strap	-	1/2" (13 mm)	460	50
BC210000EG	5	1" Retainer Strap	-	1" (25 mm)	460	25

Note: Used in pairs



Fig. #2



Fig. #3



Fig. #4



Fig. #5



Strut



Fig. #1



Fig. #2



Fig. #3



Fig. #4



Fig. #5

Column Strut Clamps

Features

- Easy to install, as both parts clip to strut during installation
- For attachment of strut inside wide flange column or beams
- Quick to install - Tightening of only one or two bolts is required
- Fits all strut



Fig. #1



Fig. #2

Part Number	Fig. #	Description	Load (lbs)	Standard Packaging Quantity
BC23A000EG	1	Column Strut Clamp	800	25
INC8T5	2	Column Strut Clamp with mounting plates and two 5/16" x 1" bolts	100	100

Notes: Packed in pairs.

Load rating is based upon use in pairs.



Strut

ESC

Features

- Works on industry standard strut profile
- Spring steel permits snap-in attachment without tools
- Provides fast attachment of a 1/4" mounting hole, J-hook, cable, conduit, or 1/4" threaded rod to strut



Fig. #1

Part Number	Fig. #	Description	Standard Packaging Quantity
ESC4	1	Easy Strut Clip	100
ESC6M	2	Snap-in MC/AC cable	100
ESC812M	2	Snap-in 1/2"-3/4" conduit	100
ESC8P	3	Snap-in 1/2" conduit	100
ESC12P	3	Snap-in 3/4" conduit	100
ESC4TI	4	Snap-in 1/4- 20 threaded rod	100
ESC6TI	4	Snap-in 3/8-16 threaded rod	100



Fig. #2



Fig. #3



Fig. #4



Strut

Hardware Washer

Part Number	Description	Standard Packaging Quantity
F140000EG	Square Channel Washer 3/8" EG	100
F150000EG	Square Channel Washer 5/8" EG	100



Threaded Rod

Part Number	Description	Standard Packaging Quantity
0502510EG	Threaded Rod 1/4" x 10' EG	25
0503710EG	Threaded Rod 3/8" x 10' EG	25
0505010EG	Threaded Rod 1/2" x 10' EG	25



Hangers / Hanging Systems



Hangers / Hanging Systems

Rod And Wire Hangers

Features

- **OFFSET BRACKET** suspends plain rod, threaded rod or wire drops from vertical structures such as laminated wood or concrete beams, joists, ceilings and walls
- **ANGLE BRACKET** suspends plain rod, threaded rod and wire drops from horizontal structures such as laminated wood or concrete beams, joists, ceilings and walls



Fig. #1

Static Load: 160 lbs.

Part Number	Fig. #	Description	Standard Packaging Quantity
Angle Bracket			
4TIB	1	For 1/4" threaded rod, with thread impression	100
6AB	2	For 3/8" plain rod	100
6TB	3	For 1/4" or 3/8" threaded nuts required	100
6TIB	3	For 3/8" threaded rod, with thread impression	100
708AB	4	For #8 wire or 1/4" plain rod	100
Offset Bracket			
4TIO	5	For 1/4" threaded rod, with thread impression	100
6AO	6	For 3/8" plain rod	100
6TIO	7	For 3/8" threaded rod, with thread impression	100
6TO	7	For 1/4" or 3/8" threaded nuts required	100
708AO	8	For #8 wire or 1/4" plain rod	100

Note: Loads indicated are for CADDY® Fasteners only. Method of attachment to structure must be evaluated separately.



Fig. #2



Fig. #3



Fig. #4

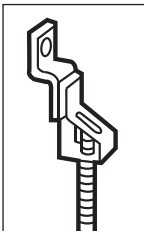

Fig. #5

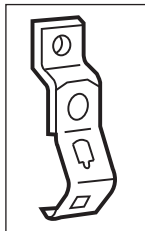

Fig. #6

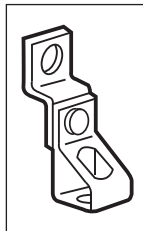

Fig. #7

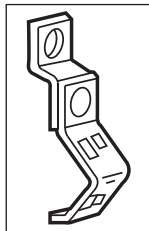

Fig. #8



Hangers / Hanging Systems

Pin Driven Angle Brackets

Features

- Longer leg angle bracket for tool clearance
- Designed to fit a variety of pin drivers
- Improved for easier installation with pin drivers
- Pregalvanized steel
- Preassembly options available for rod, wire, strap and cable applications



Fig. #1

Part Number	Fig. #	Description	Working Load (lbs)	Standard Packaging Quantity
4TIAFAB3	1	For 1/4" threaded rod, with thread impression	160	50
6TAFAB3	1	For 1/4" or 3/8" threaded rod, nuts required	160	100
6TIAFAB3	1	For 3/8" threaded rod, with thread impression	160	100
6AFAB3	2	For 3/8" plain rod	160	100
708AFAB3	3	For #8 wire or 1/4" rod	160	100
AFAB3	4	Angle bracket with 1/4" slotted hole and 3/16" mounting hole	160	100

Note: Load limits apply to CADDY® Fasteners only. Pin must be evaluated separately.



Fig. #2



Fig. #3



Fig. #4

Hangers / Hanging Systems

Hammer-On Plain and Threaded Rod Hangers Beam Clamps

Features

- Requires only a hammer to install
- Used to suspend #8 wire, 1/4", 3/8" plain rod or 1/4" or 3/8" threaded rod from beam flanges 1/8" to 3/4" thick



Fig. #1

Static Load: 200 lbs.

Part Number	Fig. #	Flange Thickness (in)	Rod Size	Standard Packaging Quantity
70824	1	1/8 to 1/4	#8 wire or 1/4" Plain Rod	100
70858	1	5/16 to 1/2	#8 wire or 1/4" Plain Rod	100
708912	1	9/16 to 3/4	#8 wire or 1/4" Plain Rod	100
6A24	2	1/8 to 1/4	3/8" (Plain)	100
6A58	2	5/16 to 1/2	3/8" (Plain)	100
6A912	2	9/16 to 3/4	3/8" (Plain)	100
4TI24	3	1/8 to 1/4	1/4-20	100
4TI58	3	5/16 to 1/2	1/4-20	100
4TI912	3	9/16 to 3/4	1/4-20	100
6TI24	3	1/8 to 1/4	3/8-16	100
6TI58	3	5/16 to 1/2	3/8-16	100
6TI912	3	9/16 to 3/4	3/8-16	100
6TA24	3	1/8 to 1/4	1/4-20 or 3/8-16 Threaded*	100
6TA58	3	5/16 to 1/2	1/4-20 or 3/8-16 Threaded*	100
6TA912	3	9/16 to 3/4	1/4-20 or 3/8-16 Threaded*	100

*Nuts required.



Fig. #2



Fig. #3



Hangers / Hanging Systems

Threaded Rod Hanger For Bar Joists

Features

- Fits open web joists with round bottom chords
- Part No. 4TW for threaded rods or bolts, 1/4-20 thread impression
- Part No. 6W for threaded rods 3/8" and smaller, nuts required
- Permits accurate centering



Fig. #1

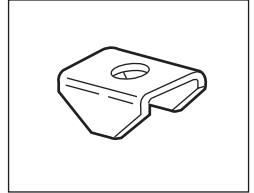
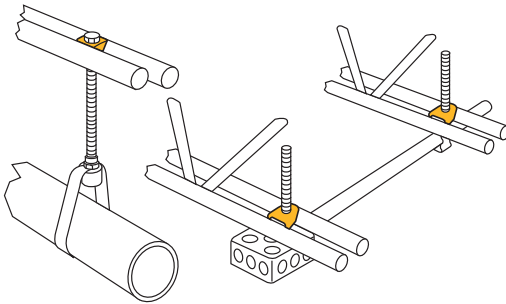

Fig. #2

Part Number	Fig. #	Description	Static Load (lbs)	Standard Packaging Quantity
4TW	1	Threaded wedge hanger	100	100
6W	2	Wedge hanger	200	100



Hangers / Hanging Systems

Fixture Support From Plain Rod

Features

- No tools required for installation
- Eliminates the use of nut and allows the use of plain rod

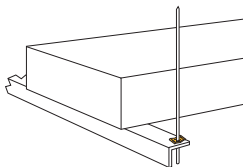

Part Number	Size	Static Load (lbs)	Standard Packaging Quantity
2EBN	#8 wire	100	100
4EBN	1/4" plain rod	100	100
6EBN	3/8" plain rod	200	100

ISN Smart Nut

Features

- Snaps anywhere on 3/8-16 threaded rod
- Adjustable and removable
- Eliminates excessive threading into place
- Supports plumbing, HVAC, electrical
- Reduces installation time
- Ideal when rod ends are not accessible or for retrofit applications



Part Number	Description	Weight per 100 (lbs)	Static Load (lbs)	Standard Packaging Quantity
ISN375	Smart Nut, 3/8-16 thread	3.1	150	100



Hangers / Hanging Systems

SN Series Nut

Features

- Reduces the need for threading compared to standard nuts and washers
- Offers up to 50% installation time savings
- Ideal for retrofit projects, such as trapeze installations (simply add on as needed)
- Can be used on threaded rod with slightly damaged threads or minor burrs
- Load rating is stronger than the threaded rod itself



Part Number	Description	Static Load (lbs)	Standard Packaging Quantity
SN25	1/4" SN Series Nut	500	100
SN37	3/8" SN Series Nut	1,350	100
SN50	1/2" SN Series Nut	2,250	100

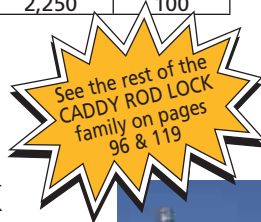

CADDY® ROD LOCK Anchor Screw

- Works with slightly damaged threads and minor burrs on the threaded rod
- Fast "push-install" assembly reduces installation time up to 35%
- Load capacity up to 660 lbs
- FM Approved
- Electro-galvanized finish
- 3:1 Safety Factor



Part Number	Description	Rod Size Ø	Static Load (N1)	Standard Packaging Quantity
CRLA37EG	3/8" CADDY® ROD LOCK Anchor Screw	3/8"	660 lbs	100

Note: For use on plain and electro-galvanized (EG) hardware only. Tested in 3000 psi (20.67 Mpa) concrete

Hangers / Hanging Systems

ISSP Strut Plate

Features

- Allows for easy attachment of strut between existing rods.
- Helps eliminate the need for precise cutting of strut and the need for multiple hardware pieces.
- For commercial and industrial applications.
- Bolt has locking design to prevent loosening due to vibration.



Part Number	Description	Max. Rec. Load (lbs)	Weight per 100 (lbs)	Standard Packaging Quantity
ISSP375	Strut Plate Only (No Hardware)	-	36	100
ISSPK	ISN/ISSP Kit (for 3/8-16 threaded rod)	220	10.4	*

*Order in sets of 12 - 1 set includes (2) ISSP375 and (4) ISN375



Hangers / Hanging Systems

Deck Hangers For Rods And Wires

From Cellular Floor Deck
(H.H. Robertson or R.C. Mahon)



Fig. #1

Features

- Designed to support #8 wire, 1/4" or 3/8" plain rod, 1/4" or 3/8" threaded rod
- Positive locking through deck tab. Prevents twisting or loosening due to vibration

Part Number	Fig. #	Description	Standard Packaging Quantity
DH2	1	For wrapping wire, "S" hooks, bolting straps	100
DH4TI	2	For 1/4" threaded rod, with thread impression	100
DH6T	2	For 1/4" and 3/8" threaded rod, nuts required	100
DH6TI	2	For 3/8" threaded rod, with thread impression	100
DH6A	3	For 3/8" plain rod	100
DH708	4	For #8 wire or 1/4" plain rod	100

Note: Static load limit 160 lbs. Check with deck manufacturer for recommended load capacity.

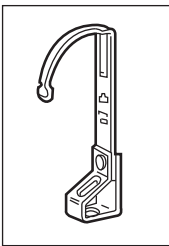

Fig. #2



Fig. #3



Fig. #4

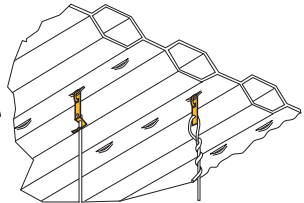
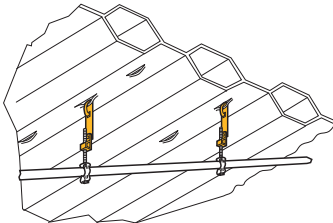

Hangers / Hanging Systems

Deck Hanger And Punch

Features

- 1/4" or 3/8" square section nut or 3/8" (10 mm) clearance hole
- Maximum trapeze width 2" (50 mm)
- Minimum roof decking sheet thickness 24 gauge



Fig. #1

Part Number	Fig. #	Description	Standard Packaging Quantity
TDH	1	3/8" Plain Hole	50
TDHT4	2	1/4 - 20 Nut	50
TDHT6	2	3/8 - 16 Nut	50



Fig. #2

Features

- Decking hole punch tool
- Easy one-step operation
- Preset dimensions
- No secondary power sources needed



Fig. #3

Part Number	Fig. #	Description	Standard Packaging Quantity
TDHP2	3	Deck Hanger Punch	1
TDHP2PR10	4	Replacement Punch (requires 2 per punch)	1



Fig. #4

Roof Decking Thickness				
in	mm	gauge	lbs.	kN.
0.025-0.0276	0.63-0.70	24	130	0.60
0.0276-0.0315	0.70-0.80	23	150	0.70
0.0315-0.0394	0.80-1.00	22	180	0.80
0.0394	1.00	19	200	0.90
0.0516	1.20	18	240	1.07



Hangers / Hanging Systems

Strap Hanger Clips

Features

- Size Range: 1/8" – 3/4" Flange Thickness
- Supports pipe or duct from flange with banding or strapping
- The new clips are made from galvanized steel instead of spring steel. This expands the use to more applications, especially when used with other plated parts like the BC200 beam clamp
- Note: Pre-measure length of strap, hammer clip onto flange, then trapeze pipe or duct. Accepts strap up to 1-1/4" wide



Fig. #1

Part Number	Fig. #	Max. Rec. Load (lbs)	Flange Thickness (in)	Standard Packaging Quantity
MSS24	1	200	1/8 to 1/4	50
MSS58	1	200	5/16 to 1/2	50
MSS912	1	200	9/16 to 3/4	50
MSR24	2	200	1/8 to 1/4	50
MSR58	2	200	5/16 to 1/2	50
MSR912	2	200	9/16 to 3/4	50
MSSAFAB3	3	160	-	50



Fig. #2



Fig. #3

Max. Recommended Load: 100 lbs

Part Number	Fig. #	Flange Thickness (in)	Standard Packaging Quantity
MSRBC200	1	1/8 to 5/8	50
MSSBC200	2	1/8 to 5/8	50



Fig. #1



Fig. #2



Hangers / Hanging Systems

CADDY® SPEED LINK

Features

- Reduces installation time
- Quickly installs as a stand-alone hanging system without drilling into the building structure
- Works with a variety of CADDY® Fasteners
- Meets the fire rating requirements of DIN 4102-2 for 30 minutes (for galvanized wire rope)
- Reduces inventory, storage space and shipping costs
- Increases installation versatility
- Minimizes vibration and system wear and tear
- Improves installation aesthetics
- Unique steel locking device allows for adjustment both during and after installation



Fig. #1



Fig. #2



Fig. #3



Fig. #4



Fig. #5



Fig. #6



Many ERICO® products are UL Listed.
Please contact your ERICO representative for approval information.

Hangers / Hanging Systems

Part Number	Fig. #	Wire Rope Diameter		Wire Rope Length (Y Length)		Static Load		Standard Packaging Quantity
		mm	in	m	ft	kg	lbs	
HOOK								
SLD2L1	1	2.0	0.079	1	3.3	45	100	100
SLD2L2	1	2.0	0.079	2	6.6	45	100	100
SLD2L3	1	2.0	0.079	3	9.9	45	100	100
SLD2L5	1	2.0	0.079	5	16.4	45	100	50
SLD2L7	1	2.0	0.079	7	22.9	45	100	25
SLD2L10	1	2.0	0.079	10	32.8	45	100	25
SLD3L1	1	3.0	0.118	1	3.3	90	200	100
SLD3L2	1	3.0	0.118	2	6.6	90	200	100
SLD3L3	1	3.0	0.118	3	9.9	90	200	50
SLD3L5	1	3.0	0.118	5	16.4	90	200	50
SLD3L7	1	3.0	0.118	7	22.9	90	200	25
SLD3L10	1	3.0	0.118	10	32.8	90	200	25
Y-TOGGLE								
SLD2Y300	2	2.0	0.079	300 mm	11.8 in	45	100	20
SLD2Y500	2	2.0	0.079	500 mm	19.6 in	45	100	20
INTEGRAL Y-TOGGLE								
SLD2Y300L2	3	2.0	0.079	2 (300 mm)	6.6 (11.8 in)	45	100	20
SLD2Y300L3	3	2.0	0.079	3 (300 mm)	9.9 (11.8 in)	45	100	20
SLD2Y300L5	3	2.0	0.079	5 (300 mm)	16.4 (11.8 in)	45	100	20
SLD2Y300L7	3	2.0	0.079	7 (300 mm)	22.9 (11.8 in)	45	100	20
SLD2Y300L10	3	2.0	0.079	10 (300 mm)	32.8 (11.8 in)	45	100	10
SLD2Y500L3	3	2.0	0.079	3 (500 mm)	9.9 (19.6 in)	45	100	20
SLD2Y300L050H	4	2.0	0.079	50 mm (300 mm)	2 in (11.8 in)	45	100	20
Y-HOOK								
SLD2YH500	5	2.0	0.079	(500 mm)	(19.6 in)	45	100	10
SLD2YH800	5	2.0	0.079	(800 mm)	(31.4 in)	45	100	10
SLD3YH500	5	3.0	0.118	(500 mm)	(19.6 in)	90	200	10
SLD3YH800	5	3.0	0.118	(800 mm)	(31.4 in)	90	200	20
INTEGRAL Y-HOOK								
SLD2YH500L2	6	2.0	0.079	2 (500 mm)	6.6 (19.6 in)	45	100	20
SLD2YH500L3	6	2.0	0.079	3 (500 mm)	9.9 (19.6 in)	45	100	20
SLD2YH500L7	6	2.0	0.079	7 (500 mm)	22.9 (19.6 in)	45	100	20
2-PACKS - INTEGRAL Y-HOOK								
SLD2YH500L2TP	6	2.0	0.079	2 (500 mm)	6.6 (19.6 in)	45	100	20 bags of 2
SLD2YH500L3TP	6	2.0	0.079	3 (500 mm)	9.9 (19.6 in)	45	100	20 bags of 2
SLD2YH500L7TP	6	2.0	0.079	7 (500 mm)	22.9 (19.6 in)	45	100	20 bags of 2
INDIVIDUALLY PACKAGED HOOK								
SLD2L1BP	1	2.0	0.079	1	3.3	45	100	20 bags of 1
SLD2L2BP	1	2.0	0.079	2	6.6	45	100	20 bags of 1
SLD2L3BP	1	2.0	0.079	3	9.9	45	100	20 bags of 1
SLD2L5BP	1	2.0	0.079	5	16.4	45	100	20 bags of 1
SLD2L10BP	1	2.0	0.079	10	32.8	45	100	20 bags of 1
SLD3L1BP	1	3.0	0.118	1	3.3	90	200	20 bags of 1
SLD3L2BP	1	3.0	0.118	2	6.6	90	200	20 bags of 1
SLD3L3BP	1	3.0	0.118	3	9.9	90	200	20 bags of 1
SLD3L5BP	1	3.0	0.118	5	16.4	90	200	20 bags of 1
SLD3L10BP	1	3.0	0.118	10	32.8	90	200	20 bags of 1

Hangers / Hanging Systems

CADDY® SPEED LINK LD

Features

- Ideal for lighting and other installation projects
- Cost-effective alternative to jack chain, threaded rod and associated hardware
- Static load of 20 kg (44 lbs.)
- 5:1 safety factor
- Sleek low-profile locking device reduces visual impact
- Adjustable after installation
- Works with a variety of CADDY® Fasteners
- Meets the fire rating requirements of DIN 4102-2 for 30 minutes (for galvanized wire rope)



Fig. #1



Fig. #2



Fig. #3



Fig. #4



Fig. #5



Many ERICO® products are UL Listed.
Please contact your ERICO representative for approval information.

Hangers / Hanging Systems

Part Number	Fig. #	Wire Rope Diameter		Wire Rope Length (Y Length)		Static Load		Standard Packaging Quantity
		mm	in	m	ft	kg	lbs	
HOOK								
SLD15L1	1	1.5	0.059	1	3.3	20	44	100
SLD15L2	1	1.5	0.059	2	6.6	20	44	100
SLD15L3	1	1.5	0.059	3	9.9	20	44	100
SLD15L5	1	1.5	0.059	5	16.4	20	44	100
SLD15L7	1	1.5	0.059	7	22.9	20	44	100
SLD15L10	1	1.5	0.059	10	32.8	20	44	100
TOGGLE								
SLD15L1T	2	1.5	0.059	1	3.3	20	44	20
SLD15L2T	2	1.5	0.059	2	6.6	20	44	20
SLD15L3T	2	1.5	0.059	3	9.9	20	44	20
SLD15L5T	2	1.5	0.059	5	16.4	20	44	20
SLD15L7T	2	1.5	0.059	7	22.9	20	44	20
SLD15L10T	2	1.5	0.059	10	32.8	20	44	20
Y-TOGGLE								
SLD15Y200	3	1.5	0.059	200 mm	7.8 in	20	44	20
SLD15Y300	3	1.5	0.059	300 mm	11.8 in	20	44	20
SLD15Y500	3	1.5	0.059	500 mm	19.6 in	20	44	20
SLD15Y800	3	1.5	0.059	800 mm	31.4 in	20	44	20
INTEGRAL Y-TOGGLE								
SLD15Y300L3	4	1.5	0.059	3 (300 mm)	9.9 (11.8 in)	20	44	20
SLD15Y300L5	4	1.5	0.059	5 (300 mm)	16.4 (11.8 in)	20	44	20
SLD15Y500L3	4	1.5	0.059	3 (500 mm)	22.9 (19.6 in)	20	44	20
QUAD TOGGLE								
SLD15QT250	5	1.5	0.059	250 mm	9.8 in	20	44	20
2-PACKS - HOOK								
SLD15L1TP	1	1.5	0.059	1	3.3	20	44	20 bags of 2
SLD15L2TP	1	1.5	0.059	2	6.6	20	44	20 bags of 2
SLD15L3TP	1	1.5	0.059	3	9.9	20	44	20 bags of 2
SLD15L5TP	1	1.5	0.059	5	16.4	20	44	20 bags of 2
2-PACKS - TOGGLE								
SLD15L1TTP	2	1.5	0.059	1	3.3	20	44	20 bags of 2
SLD15L2TTP	2	1.5	0.059	2	6.6	20	44	20 bags of 2
SLD15L3TTP	2	1.5	0.059	3	9.9	20	44	20 bags of 2
SLD15L5TTP	2	1.5	0.059	5	16.4	20	44	20 bags of 2
SLD15L10TTP	2	1.5	0.059	10	32.8	20	44	20 bags of 2
2-PACKS - Y-TOGGLE								
SLD15Y500TP	3	1.5	0.059	(500 mm)	(19.6 in)	20	44	20 bags of 2
SLD15Y800TP	3	1.5	0.059	(800 mm)	(31.4 in)	20	44	20 bags of 2

Hangers / Hanging Systems

CADDY® SPEED LINK Tools & Accessories

Part Number	Fig. #	Description	Standard Packaging Quantity
SL1214	1	CADDY SPEED LINK Clip .468 - .562 MC/AC Cable	100
SL1518	1	CADDY SPEED LINK MC/AC Clip 0.500" – 0.718"	100
SLADCP	2	CADDY SPEED LINK Air Duct Corner Protector	10
SLADS	3	CADDY SPEED LINK Screw-on Air Duct Angle Support	100
SLEB250	4	Eye Bolt 1/4-20 x 1-3/16"	100
SLEB375	4	Eye Bolt 3/8-16 x 1-9/16"	100
SLEBM6*	4	Eye Bolt M6; 30 mm long	100
SLEBM8*	4	Eye Bolt M8; 40 mm long	100
SLEBWS	4	Eye Bolt Wood Screw H6 x 2-3/8"	100
SLAFAB3	5	Angle Bracket with Slotted Hole and 3/16" Mounting Hole	50
SLLC250*	6	CADDY SPEED LINK Lighting clip 1/4 inch	200
SLWC	7	CADDY SPEED LINK Wire Cutter	1
SLWPT	8	CADDY SPEED LINK Wire Insulation Protection Tube, 82 ft	82
VAFT	9	Installation tool for VF & AF assemblies (1/2" conduit not included)	1

*50 pound (22 Kg) ultimate load limit. Not to be used as a lifting device.



Fig. #1

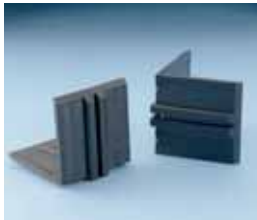

Fig. #2



Fig. #3



Fig. #4



Fig. #5



Fig. #6



Fig. #7



Fig. #8



Fig. #9



Stud Wall



Stud Wall

Electrical Box Bracket

Features

- Can be pre-fabricated prior to attaching box to the bracket
- Box locking tabs securely lock electrical boxes in place to prevent disassembly during shipment
- Easily identify mounting orientation of electrical boxes. Round keyholes for 4-11/16" boxes and octagonal keyholes for 4" sq. boxes
- Mounts 4" or 4-11/16" electrical boxes or plaster rings for low-voltage applications
- Feet on the far-side supports help prevent damage to the drywall
- Can be mounted to stud on all four sides
- Designed with two far-side supports for added stability
- Allows any box size or depth to be used



Fig. #1



Fig. #2

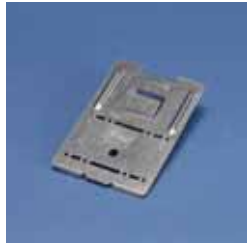

Fig. #3



Part Number	Fig. #	Description	Standard Packaging Quantity
TEB23	1	Electrical box bracket for 2-1/2" or 3-5/8" stud depth	50
TEB4	2	Electrical box bracket for 4" stud depth	50
TEB6XT	3	Far Side Box Support for TEB23-Snap on for 6" deep stud walls	100



Stud Wall

Box Mounting Bracket For Electrical Box

Features

- Easily attaches 4" and 4 11/16" outlet boxes to metal stud (HS3 for switch boxes)
- Support leg reduces movement of box in wall
- Can be attached to metal or wood stud
- Offset design and use of #SMS8 low profile self-tapping screws (not included) reduce dry wall bulge



Fig. #1



Part Number	Fig. #	Application	Box Size	Stud Depth (in)	Standard Packaging Quantity
H23	1	U.S.	4 in sq. & 4-11/16 in	2 1/2 & 3 1/2	100
H23TC	1	Canada	4 in sq. & 4-11/16 in	2 1/2 & 3 1/2	100
H4	1	U.S.	4 in sq. & 4-11/16 in	4	50
H46TC	1	Canada	4 in sq. & 4-11/16 in	4 & 6	100
H6	1	U.S.	4 in sq. & 4-11/16 in	6	50
HS3	2	U.S. & Canada	Switch	2 1/2 & 3 1/2	100



Fig. #2

Stud Wall

Screw On Conduit Support

Features

- Accommodates 1/2", 3/4" and 1" EMT, Conduit and MC/AC Cable
- Alignment tab positively locates the fastener on the stud, keeping your conduit in line with box knock out and H-series brackets
- For wood or metal stud
- Delivers compliance with: NEC Article 358.30(A) which requires conduit support within 36" of an electrical box. CEC Rule 12-1404 which requires conduit support within 1 m (36") of an electrical box. CEC Rule 12-618 which requires support of armoured cable within 300 mm (12") of an electrical box



Part Number	Description	Standard Packaging Quantity
CS812	Screw on Conduit Support; attaches 1/2" and 3/4" EMT, conduit, MC/AC to metal or wood stud For 1 1/2 deep box	100
CS812D	Screw on Conduit Support; attaches 1/2" and 3/4" EMT, conduit, MC/AC to metal or wood stud For 2 1/8 deep box	100
CS16	Screw on Conduit Support; attaches 1" EMT, conduit, MC/AC to metal or wood stud For 2 1/8" deep box	100

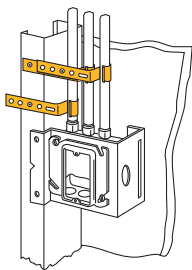

Eliminates offset bending of conduit



Stud Wall

"Mounts Electrical Boxes" Hanger

Features

- One bracket works for: Two box depths (1 1/2" or 2 1/8" deep) Two box sizes (4" or 4 11/16" sq.) Three wall stud depths (2 1/2", 3 1/2" & 4" studs)
- All-in-one design simplifies handling, reduces inventory and saves space
- Requires only a screw gun to install
- V-notched on center allows for consistent positioning
- Built-in support legs reduce box movement when used with EMT and is ideal for flexible conduit, MC, AC or Non-metallic sheathed cable
- Offset design of MEB1 and use of #SMS8 low profile self-tapping screws (not included) reduce drywall bulge
- Can be pre-assembled in the shop to allow for greater efficiency at the job site
- Plaster rings can be mounted separately eliminating the need for an electrical box for low-voltage applications
- MP Series brackets can be attached in-line to the MEB1 for low voltage applications
- Mounts on either side of stud without need to reposition box



One-Piece Design

One Size Fits All

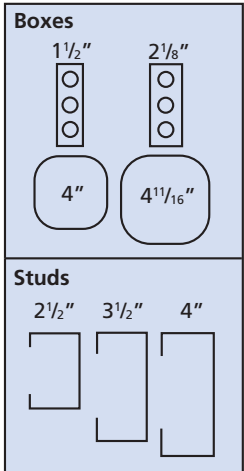

Part Number	Description	Standard Packaging Quantity
MEB1	"Mounts Electrical Boxes" Hanger	25

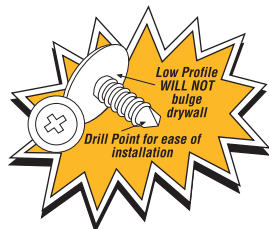

Stud Wall

Press-On Nail Plate

Features

- Fast press-on installation; no tools required
- Protects electrical, datacomm and plumbing
- Works on wood or metal studs
- Meets NEC 300.4(b)(2). Also Designed to meet CEC 12-516 and 12-616
- Breakable tabs permit multiple plates to be ganged together
- Corrosion resistant zinc phosphate coating



Part Number	Description	Standard Packaging Quantity
304B2	Press-on Wood/Metal Stud Protection Plate	100



Gang Applications

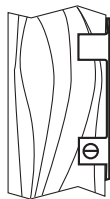
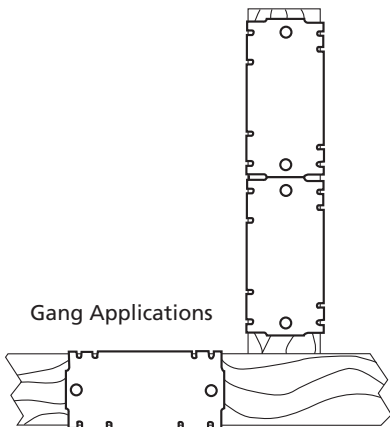

Side View

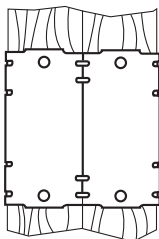

Face View



Stud Wall

Snap On Box Supports for Metal/Wood Studs

Features

- Spring steel for press-on attachment
- Center hole assists in consistent alignment, exact positioning and screw attachment
- MSF requires hammer to attach clip to box. DBM2 attaches without hammer

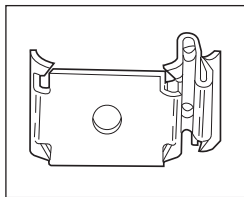

Fig. #1

Part Number	Fig. #	Description	Standard Packaging Quantity
MSF	1	Box support to outside of stud	100
DBM2	2	Double box mount support	50

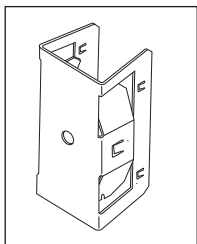
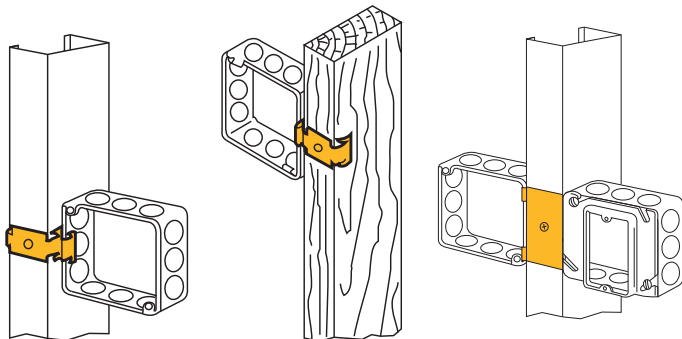
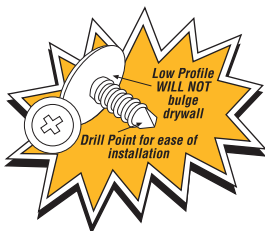

Fig. #2



Stud Wall

Adjustable Far Side Box Support

Features

- Provides far side electrical box support in various stud wall depths
- No adjustment needed in a 3-5/8" wall for the 766PM and 766PMD



Fig. #1



Fig. #5

Note: No Load Rating - Positioning Only

Part Number	Fig. #	Description	Standard Packaging Quantity
J1A35	1	Adjustable Far Side Box Support - Hammer on for 2 1/2" and 3 1/2" studs	100
766	2	Adjustable Far Side Box Support - Lock on for 2 1/2", 3 1/2" and 4" studs	100
766A	3	Adjustable Far Side Box Support - Snap on for 2 1/2", 3 1/2", 4" & 6" studs	100
766PM	4	Adjustable Far Side Box Support - Snap on for 1-1/2" deep electrical boxes	100
766PMD	5	Adjustable Far Side Box Support - Snap on for 2-1/8" deep electrical boxes	100



Fig. #2



Fig. #3



Fig. #4



Stud Wall

Switch Box Or Conduit To Metal Stud

Features

- Allows the switch box to protrude through any size dry wall – 1/4", 3/8", 1/2", 5/8" or 3/4"
- Fits most dry wall studding
- Fits most switch boxes
- Figure 1, 4, and 5 only



Fig. #1

Part Number	Fig. #	Description	Standard Packaging Quantity
MF1	1	1/4-20 Thread impression	100
MFS	2	With screw (adjustable 1/4" thru 3/4")	100
MFO	3	Riveted flush to stud face	100
MF250	3	Riveted for 1/4" dry wall	100
MF375	3	Riveted for 3/8" dry wall	100
MF500	3	Riveted for 1/2" dry wall	100
MF625	3	Riveted for 5/8" dry wall	100
MF750	3	Riveted for 3/4" dry wall	100
6MF	4	3/8" Conduit or BX to metal stud	100
812MF	4	1/2" to 3/4" Conduit to metal stud	100
16MF	4	1" Conduit to metal stud	100
8PF	5	1/2" Conduit to metal stud	100
12PF	5	3/4" Conduit to metal stud	100
16PF	5	1" Conduit to metal stud	100



Fig. #2



Fig. #3



Fig. #4



Fig. #5

Stud Wall

Screw On Box Support

Features

- Permits positioning of metal electrical box anywhere on metal or wood stud, regardless of stud size
- The 350 is securely held in place with screws



Fig. #1

Part Number	Fig. #	Description	Standard Packaging Quantity
350	1	For 4" electrical box to metal stud	100
350812M	2	For 1/2" or 3/4" conduit to metal stud	100
35016M	2	For 1" conduit to metal stud	100
3508P	3	For 1/2" conduit to metal stud	100
35012P	3	For 3/4" conduit to metal stud	100
35016P	3	For 1" conduit to metal stud	100



Fig. #2



Fig. #3

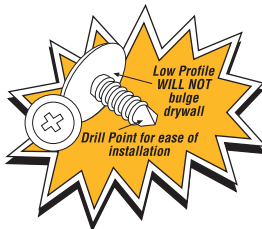
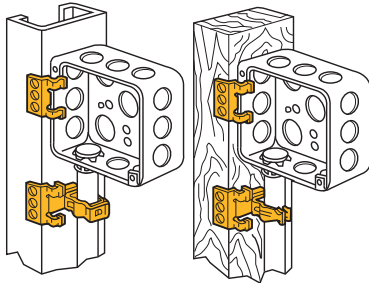

Stud Wall

Telescoping Box Support

Features

- Adjustable from 12" to 25"
- Accommodates up to 6-gang box in 16" stud spacing or up to 10-gang in 24" stud spacing
- Will support four electrical boxes in 24" stud spacing
- Open design allows a variety of positions for box location
- Easy to adjust after the electrical box is installed
- For use with 4" square and 4-11/16" boxes and mud rings
- Unique, one-piece, break apart design



Part Number	Description	Standard Packaging Quantity
TSRBS1625	Telescoping Rigid Box Support	25

Note: For metal stud use in Canada, attach CADDY® part number 766PM for 1-1/2" deep boxes or 766PMD for 2-1/8" deep boxes.



Stud Wall

Box Mounting Brackets For Between Studs

Features

- Accommodates up to four 4" or 4 11/16" boxes
- Eliminates the need for an electrical box on low voltage applications
- Mounts 1 1/2" or 2 1/8" deep boxes
- Supports electrical boxes, plaster rings or low voltage devices from one bracket



Fig. #1

Part Number	Fig. #	Description	Standard Packaging Quantity
RBS16	1	Between Stud Box Mounting Brackets -Mounts up to three 4" or 4 11/16" boxes/plaster rings, 16" bracket	25
RBS24	2	Between Stud Box Mounting Brackets -Mounts up to four 4" or 4 11/16" boxes/plaster rings, 24" bracket	25



Fig. #2



Stud Wall

Screw Gun Box Bracket For Between Studs

Features

- Can mount multiple 1-1/2" or 2-1/8" deep boxes. Notched and marked for easy identification and bending
- Improved design with stamped inch markings and pilot holes accelerates precise box conduit mounting between studs
- Pilot holes allow easy box attachment with a screwdriver
- Requires only a screw gun to install
- Reduces movement of the box when used with flexible conduit, ENT, MC, AC or non-metallic sheathed cable
- Can be mounted to face or inside of stud
- No more time-consuming field fabrication with scrap floor track.
- Adjustable for non-standard stud spacing
- Interlocking tab prevents accidental disassembly.
- Unique, one-piece, break apart design

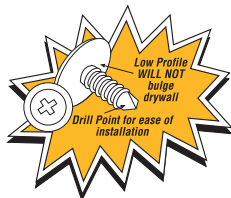

Fig. #1

Part Number	Fig. #	Description	Box Depth (in)	Standard Packaging Quantity
TSGB16	1	Telescoping Screw Gun Bracket 11" to 18" Stud Spacing	1 1/2 & 2 1/8	50
TSGB1624*	1	Telescoping Screw Gun Bracket 15-3/4" to 25" Stud Spacing	1 1/2 & 2 1/8 & 2 1/2	50
TSGB24	1	Telescoping Screw Gun Bracket 17" to 26" Stud Spacing	1 1/2 & 2 1/8 & 2 1/2	50

*For an innovative pre-fab solution see the CADDY® GLIDER (TSGLDR1)

- Can be pre-assembled by the contractor to allow for greater productivity at the job site
- Pre-set for studs 16" or 24" on center



Fig. #2

Part Number	Fig. #	Description	Box Depth (in)	Standard Packaging Quantity
SGB16A*	2	Screw Gun Bracket 16" Stud Spacing	1 1/2 & 2 1/8	50
SGB24A†	2	Screw Gun Bracket 24" Stud Spacing	1 1/2 & 2 1/8	50

*Replaces SGB16 & SGB16D

†Replaces SGB24 & SGB24D

Stud Wall

CADDY® GLIDER Electrical Box Attachment

Features

- Attaches to the TSGB without tools and without the need to disassemble the TSGB
- Allows closer installation of multiple boxes between or against the studs
- Allows for easy repositioning of electrical boxes
- Ideal for pre-fab assemblies
- Easily attaches electrical boxes to the Telescopic Screw Gun Bracket with a single screw



Part Number	Description
TSGLDR1	CADDY® GLIDER Electrical Box Attachment
TSGLDR1TC	CADDY® GLIDER Electrical Box Attachment



Stud Wall

Electrical Box Mounting Strap

Features

- Can be used as a height gauge for box center lines of 12", 15" or 18"
- Pre-punched holes provide easy screw insertion
- Keyholes allow simple pre-mounting and installation of screws
- Works with stud spacing up to 25"
- Replaces multiple SKUs compared to competitor products
- Marked centerline for 16" and 24" stud spacing
- Ideal for use with TEB23 and CER4 for box mounting
- Works with TSRBS1625 as a floor mounted box support



Part Number	Description	Standard Packaging Quantity
TEBS1624	Electrical Box Mount Strap	50



Stud Wall

Floor Mounted Box/ Conduit Supports

Features

- FB series supports electrical boxes from floor or concrete forms
- Available in 12", 16" and 18" heights
- Slot provides for 8" height adjustment
- Use FBS with CCS812 to support conduits in concrete pours
- CCS812 eliminates offset bending of conduit
- CCS812 also works with TSGB and SGB

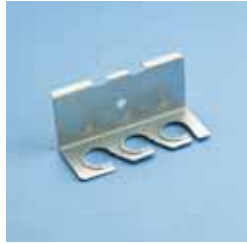

Fig. #1



Fig. #2



Part Number	Fig. #	Description	Standard Packaging Quantity
CCS812	1	Conduit bracket- floor support- 1/2" or 3/4" EMT - 1/2" RIGD	100
FBS12	2	Floor support- for 12" High box	50
FBS16	2	Floor support- for 16" High box	50
FBS18	2	Floor support- for 18" High box	50



Stud Wall

FMBS18

Features

- Positions center of electrical box 18 1/2" above unfinished floor
- Meets ADA (Americans with Disabilities Act) accessibility Guidelines Standards (15" height minimum for "forward reach" from a wheelchair)
- Quick, easy and efficient compliance to construction requirements
- Mounts 4" or 4 11/16" U.S. or Canadian boxes; 1 1/2" or 2 1/8" deep
- Mounts plaster rings for low voltage applications
- Mounts inside (use mounting tabs) or under floor track
- Versatile positioning - independent of wall stud location
- Built-in far-side back support for 2 1/2", 3 1/2", and 4" metal or wood studs
- Reduces stocking different size brackets
- Accommodates additional brackets for multiple box and device mounting



Part Number	Description	Standard Packaging Quantity
FMBS18	Floor Mount Box Support	25



Stud Wall

Low Voltage Mounting Bracket For New Construction

Features

- Provides a bracket for mounting low voltage Class 2 communication outlets
- Reduces bulges in the dry wall caused by plaster rings
- May be installed to the front or the side of the metal or wood stud
- Side support provides for a rigid installation
- Attaches with self-tapping screws or nails
- Works with 1/2" and 5/8" dry wall
- Works with wood or metal studs



Fig. #1



Fig. #2

Notes: No Load Rating - Positioning Only

Part Number	Fig. #	Description	Standard Packaging Quantity
MP1S	1	Single gang plate mounting bracket for new work	25
MP2S	2	Double gang plate mounting bracket for new work	25



Stud Wall

Cable Gripper

Features

- Attaches to existing holes in metal studs without tools or with Metal Stud Punch (MSP20)
- Delivers compliance with: NEC 300.4(d), CEC 12-510 and 12-516
- Installs easily to metal and wood studs
- Provides secure installation of multiple cables with unique locking/unlocking system
- Staples, nails or screws to wood stud
- Supports four NMC or eight 4-pair UTP, Category 5 and higher (electrical and datacomm cannot be combined)



Patent Number:
5,626,316



Part Number	Description	Bag Qty
CG4	Cable Gripper cable support	100

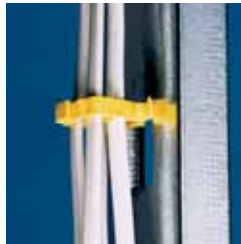

Refer to part number
MSP20 for the Metal
Stud Punch

Stud Wall

Non-Metallic Sheathed Cable and MC/AC Cable Support

Features

- Effectively support non-metallic sheathed and MC/AC cables
- Secures cables 1-1/4" from the face of the stud
- Flared edges prevent damage to the cable jacket
- Holds up to four MC/AC cables or four 12-3 non-metallic sheathed cables with ground
- Unique "stop-bend" design helps prevent cables from being installed too far from face of stud



Cable Capacity					
	MC/AC				Non-Metallic Sheathed Cables
Cable Size	14-2 w/ ground	12-3 w/ ground	12-4 through 10-4	Single cables up to 6-3 stranded	Up to 12-3 w/ ground
No. of Cables	4	3	2	1	4

Part Number	Description	Standard Packaging Quantity
CER4	Non-Metallic Sheathed and MC/AC Cable Support	100



Metal Stud with MC/AC Cable



Metal Stud with non-metallic sheathed cables



Stud Wall

"Colorado Jim" Cable Support

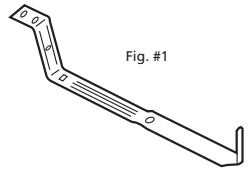

Fig. #1

Features

- Easy-to-use locking tab
- Cable locating ribs to maintain cable separation
- Flared edges for cable protection
- NEC 300.4D applicable
- For wood or metal stud

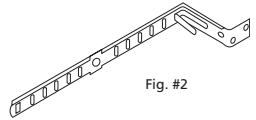
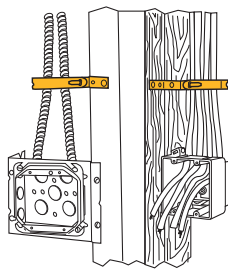

Fig. #2

Part Number	Fig. #	Description	Standard Packaging Quantity
CJ6	1	Cable support- Non-metallic or metal clad to wood or metal stud	100
CJ6IN*	1	Cable Support with insulation	100
CJ6S	2	AC or Flexible Cable to Furring strip and hat channel	100

*Used only in Canada

PART NUMBER	CABLE TYPE	CABLE SIZE	CABLES PER FASTENER
CJ6 to Wood	Non-Metallic	14-2, 12-2, 10-2, 14-3, 12-3 and 10-3 w/ground	6 maximum
		8-2 and 6-2 w/ground	4 maximum
CJ6 to Metal Stud	Metal Clad (MC) Cable	14-2, 12-2, 10-2, 14-3, 12-3, 10-3, 14-4, 12-4 and 10-4 w/ground	4 maximum
CJ6S to Furring Strip and Hat Channel	Armored Cable (AC)	14-4, 12-2, 10-2, 8-2, 14-3, 12-3, 10-3, 14-4, 12-4 and 10-4 w/ground	4 maximum
	Flexible Conduit (BX)	5/16, 3/8	4 maximum
USED ONLY IN CANADA			
CJ6IN to Metal Stud	Non-Metallic Sheathed Cable	14-2, 12-2, 10-2, 14-3, 12-3 and 10-3 w/ground	4 maximum



Stud Wall

Non-Metallic Sheathed Cable NMC And MC/AC Cable Support For Studs



Features

- Delivers compliance with: NEC 300.4(d), CEC 12-618 and CEC 12-510
- No installation tools required
- Provides secure support of NMC or MC/AC to metal/wood stud in seconds. One fastener, four applications



Part Number	Description	Standard Packaging Quantity
FXC20	NMC sizes 14-2 with ground thru 12-3 with ground MC/AC cable sizes 14-2 thru 12-3 to studs	100

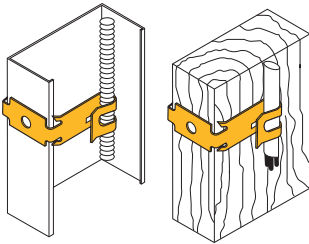

Note: When supporting NMC in Canada, FXC20 can only be used on wood stud.

Anti-Rattle Support

Features

- Permits ENT, MC and AC to be pulled thru metal stud
- Requires a self-tapping screw to install
- Supports ENT, MC/AC, EMT or rigid conduit up to 1"



Part Number	Description	Standard Packaging Quantity
781	Anti-Rattle Stud Support - conduit up to 1"	100

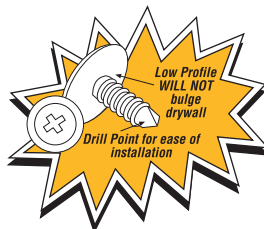

Stud Wall

Through Stud Cable/Conduit Support

Features

- Eliminates conduit rattling
- Provides a quick means of support for horizontal runs of Rigid, EMT, MC/AC or ENT through metal stud



Fig. #1



Fig. #2

“Florida Bob” Series

- Available with 812M snap shut conduit support, as well as push in conduit support
- Installs with screw gun

Part Number	Fig. #	Description	Standard Packaging Quantity
FB6M	1	Through Stud Cable/Conduit Support for MC/AC	100
FB812M	1	Through Stud Cable/Conduit Support for 1/2" or 3/4" Conduit	100
FB8P	2	Through Stud Cable/Conduit Support for 1/2" Conduit	100
FB12P	2	Through Stud Cable/Conduit Support for 3/4" Conduit	100

459/AR812

- One-piece spring steel design snaps onto stud

Part Number	Fig. #	Description	Standard Packaging Quantity
459	3	Through Stud Cable/Conduit Support for MC/AC (14-2, 14-3, 12-2, or 12-3)	100
AR812	3	Through Stud Cable/Conduit Support for: 1/2" and 3/4" EMT Conduit 1/2" Rigid, IMC, PVC Sch 40 5/8" and 3/4" Copper Tube MC/AC .700 - .925 O.D.	100



Fig. #3

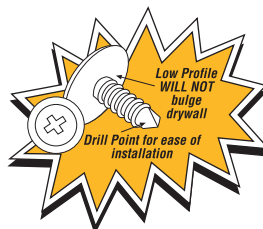

Stud Wall

Easy Snap Grommet

Features

- Snap one grommet into standard 1-11/32" field punched hole, OR snap tight two together into any shape factory punched hole
- Provides 360° protection for cable and makes cable pulls easier
- The ESGFP fits 1" CPVC pipe, copper tubing and conduit.



Fig. #1

Part Number	Fig. #	Description	Standard Packaging Quantity
ESG1	1	Metal Stud Grommet	100
ESG1M	1	Metal Stud Grommet	1,000
ESGP	2	Metal Stud Anti-Rattle Grommet	100
ESGFP	3	Metal Stud Grommet	100



Fig. #2

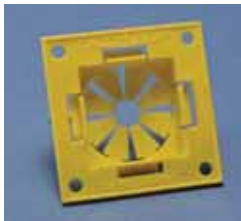

Fig. #3



Stud Wall

Metal Stud Punch

Features

- Cushioned handles mean less operator fatigue and more comfortable handling
- Tool design with offset handles allows punch to work in confined locations and near perpendicular walls
- Lightweight punch makes accurate location of holes easier
- Hardened steel components keep tool sharper longer – less replacement
- Punches up to 20 gauge sheet metal
- Plastic grommets snap easily into 1-11/32" hole



Part Number	Description	Standard Packaging Quantity
MSP20	Metal Stud Punch	1

Metal Screws

Features

- Minimizes drywall bulge.
- Self-drilling and tapping.



Part Number	Description	Standard Packaging Quantity
SMS8	#8 x 1/2 low profile- self drilling and tapping screw	1,000

Notes: Use to mount CADDY® Fasteners in all metal stud applications.

Innovative New Products for 2011 from CADDY®

ERICO has unveiled an exciting new group of CADDY® products to address a variety of common installation issues. And, the innovative designs will help save significant time, labor and money on the jobsite.



The CER4 Cable Support features a unique "stop-bend" design to prevent cables from being pushed or pulled out of position.



The MP1WWM Within Wall Mounting Plate mounts inside the wall to prevent gaps between the faceplate and wall.



The FMSBC1 Fixture Mount Stabilizer Clip levels signage and helps eliminate bulges in ceiling tiles – no tools required!



The TEB23 Electrical Box Bracket can be mounted on any side to eliminate rewiring if relocated.



Drywall



Drywall

Old Work Box Mount

Features

- One-piece, break-apart design is easy to handle
- Works on drywall, lathe and plaster; only a drywall saw required



Fig. #1

Part Number	Fig. #	Description	Wall Thickness (in)	Standard Packaging Quantity
DSI2A	1	Old work box mount	Up to 1-1/2	100

DSB

- One-piece, break-apart design is easy to handle
- Works on drywall, lathe and plaster; only a drywall saw required
- Accommodates single or multiple gang boxes; for multiple gang boxes use (2) DSB's.
- Can be placed at different locations on an electrical box to allow for more clearance.
- Fastener installs before the box to free up your hands.



Fig. #2

Part Number	Fig. #	Description	Wall Thickness (in)	Standard Packaging Quantity
DSB	2	Old work box mount	1/4 to 1-1/4	100

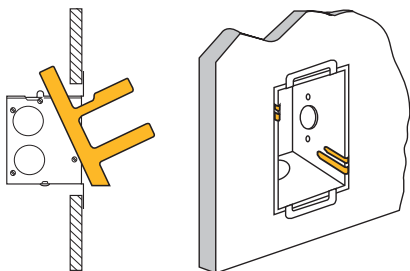

Drywall

Device Leveler And Retainer

Features

- Use for oversize dry wall openings
- Helps prevent broken cover plates
- Helps prevent device from being pushed back in wall
- Makes floating device rigid



Part Number	Description	Standard Packaging Quantity
RLC	Device leveler and retainer	100



Versatile Thread Impression

Features

- Support point for speakers, audio/video/security panels, EXIT signs, etc
- Works in 1/2" and 5/8" drywall
- Use either #6-32 screw or #6 sheet metal screw
- Spring steel with corrosion protection finish



Part Number	Description	Standard Packaging Quantity
MPVTI	Versatile thread impression	20



Drywall

Within Wall Mounting Plate

MP1WWM

Features

- Unique installation eliminates excess movement
- Fits any drywall thickness
- Designed to eliminate gaps between the wall and faceplate
- Highly visible yellow material helps prevent incorrect installation
- Template dimples on the bracket provide measurement markings for simplified installation
- Securing pins lock the plate into the drywall
- Convenient removable tether assists with positioning
- cULus® Listed



Part Number	Description	Standard Packaging Quantity
MP1WWM	Within Wall Mounting Plate	100



Drywall

Mounting Plate Brackets (Non-Metallic)

Features

- No sharp metal edges with plastic design
- Fast, easy way to install
- No installation tools required to secure bracket in the drywall opening
- Serrated interlocking system secures tightly
- Template points on brackets help eliminate multiple measurement markings during installation
- Recessed design helps assure flush mount of device
- Only CADDY® provides the industry with the widest application range 1/4" to 1 1/4" wall thickness
- Available in single gang, double gang and a unique 3-4 gang sizes
- Eliminates the need for electrical boxes on low voltage class 2 applications



Fig. #1

Notes: For low voltage Class 2 use only.; No Load Rating - Positioning Only

Part Number	Fig. #	Description	Standard Packaging Quantity
MP1P	1	Non-Metallic Single gang mounting plate	100
MPAL2	2	Non-Metallic double gang mounting plate	100
MP34P	3	Non-Metallic 3 or 4 gang mounting plate	2



Fig. #2



Fig. #3



Drywall

Mounting Plate Brackets (Metallic)

Screw-On Support

Features

- Provides positive support with locking screws
- Mounts any standard low voltage device in 1/2" through 1 1/4" walls
- Makes wire "fishing" easier
- Install with a drywall saw and screwdriver
- Eliminates the need for an electrical box when installing low voltage Class 2 wiring



Fig. #1

Notes: For low voltage Class 2 use only.

Part Number	Fig. #	Description	Standard Packaging Quantity
MP1	1	Single gang Mounting Plate Brackets (no screws included)	100
MPLS	2	Single gang Mounting Plate Brackets screws to drywall (screws included)	100
MPLS2	3	Double gang Mounting Plate Brackets screws to drywall (screws included)	100



Fig. #2



Fig. #3

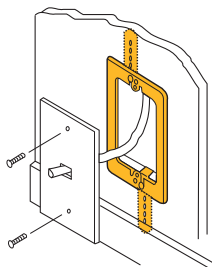

Datacomm / ITS



CADDY® CAT LINKS

Patent Pending

Features

- Provides proper support of cabling (CAT6a and higher)
- CADDY® fasteners easily attach to any size CADDY CAT LINKS J-hook
- cULus® Listed and complies with NEC® and TIASM requirements for structured cabling systems
- Cost effective alternative to expensive cable tray
- Pre-galvanized J-hooks provide smoother cable pull and greater corrosion resistance

Part Number	Fig. #	Description	Standard Packaging Quantity
CAT16HP	1	1" J-hook designed for CAT6a and higher cabling	50
CAT32HP	1	2" J-hook designed for CAT6a and higher cabling	50
CAT48HP	1	3" J-hook designed for CAT6a and higher cabling	25
CAT64HP	1	4" J-hook designed for CAT6a and higher cabling	25
CATHPA4	2	CATHP Angle Bracket with 1/4" hole	50
CATHPA6	2	CATHP Angle Bracket with 3/8" hole	50
CATHPAN	2	CATHP Angle Bracket with 3/16" hole	50
CATHP54	3	CATHP Straight Bracket with 3/8" hole	50
CATHP TM	4	CATHP Tree Mounting Bracket	50
CATHP24	5	Hammer-on assembly for 1/4"-1/8" flange with 360° rotation	25
CATHP58	5	Hammer-on assembly for 5/16"-1/2" flange with 360° rotation	25
CATHP912	5	Hammer-on assembly for 1/2"-3/4" flange with 360° rotation	25
CATHPBCB	6	Screw-on beam assembly for 1/8"-1/2" flange with 360° rotation	25
CATHPBC200B	7	Screw-on beam assembly for 1/8"-5/8" flange with 360° rotation	25
CATHP24SM	8	Hammer-on assembly for 1/8"-1/4" flange	50
CATHP58SM	8	Hammer-on assembly for 5/16"-1/2" flange	50
CATHP912SM	8	Hammer-on assembly for 1/2"-3/4" flange	25
CATHPBC	9	Screw-on beam assembly for 1/8"-1/2" flange	50
CATHPBC200	10	Screw-on beam assembly for 1/8"-5/8" flange	25
CATHPAF14	11	Z purlin assembly for 1/16"-1/4" flange	50
CATHPVF14	12	C purlin assembly for 1/16"-1/4" vertical flange	50
CATHPESC	13	Easy strut assembly	50
CATHP4Z34	14	Rod/flange assembly for #12 SWG - 1/4" wire or plain rod, 1/4" threaded rod & 1/8"-3/8" flange	50
CATHP6Z34	14	Rod/flange assembly for 3/8" threaded rod & 3/8"-9/16" flange	50
CATHPCD0B	15	Underfloor assembly for 3/4" round pedestal	25
CATHPCD1B	15	Underfloor assembly for 7/8"-1" round pedestal or 3/4" square pedestal	25
CATHPCD2.5B	15	Underfloor assembly for 1" square pedestal	25
CATHPCD2B	15	Underfloor assembly for 7/8" square pedestal	25
CAT16HPTS	16	Acoustical tee bar assembly	2
CATHPPLR	17	Cable Puller for CATHP	2





Fig. #1



Fig. #2



Fig. #3



Fig. #4



Fig. #5



Fig. #6



Fig. #7



Fig. #8



Fig. #9



Fig. #10



Fig. #11



Fig. #12



Fig. #13



Fig. #14



Fig. #15



Fig. #16



Fig. #17

See page 214
for the complete
CADDY® CABLECAT
Capacity Guide

CADDY® CABLECAT

Wide Base Cable Support

Features

- Provides proper support of Category 5e, Category 6, fiber optic and innerduct
- Many sizes and designs available to attach to a variety of structures.
- Cost effective alternative to expensive cable tray
- Galvanized finish on J-hooks provide smoother cable pull and greater corrosion resistance.
- cULus® listed and complies with NEC® and TIASM requirements for structured cabling systems

* Patent Number: 5,740,994

Part Number	Fig. #	Description	Standard Packaging Quantity
CAT12*	1	J-hook that accepts up to 16 4-pair UTP CAT 5e or 2-strand fiber optic cable, or 10 CAT 6 - 3/4" dia	50
CAT21*†	1	J-Hook that accepts up to 50 4-pair UTP CAT 5e or 2-strand fiber optic cable or innerduct, or 32 CAT 6 - 1 5/16" dia	80
CAT32*†	1	J-Hook that accepts up to 80 4-pair UTP CAT 5e or 2-strand fiber optic cable or innerduct, or 50 CAT 6 - 2" dia	60
CAT64*	1	J-Hook that accepts up to 300 4-pair UTP CAT 5e or 2-strand fiber optic cable, or 185 CAT 6 - 4" dia	25
CATHBA	2	Extended J-Hook angle bracket - 1/4" mounting hole	40
CATHBA3††	3	Extended J-Hook angle bracket - 3/16" mounting hole	40
CATHBA6	3	Extended J-Hook angle bracket - 3/8" mounting hole	40
CATHBA8	3	Extended J-Hook angle bracket - 1/2" mounting hole	40
CATKITA	4	CAT32 – 20 pieces; CATHBA Hanger – 5 pieces; BC200 Beam Clamps – 5 pieces	1
CATKITB	4	CAT21 – 10 pieces; CAT32 – 10 pieces; CATHBA Hanger – 5 pieces; BC200 Beam Clamps – 5 pieces (screws included)	1
CATKITC	4	CAT21 – 20 pieces; CATHBA Hanger – 5 pieces; BC200 Beam Clamps – 5 pieces (screws included)	1
CATTS	5	Support from tee grid	100

† Available in Stainless Steel

†† Load limits apply to CADDY® fasteners only.
Pin must be evaluated separately.





Fig. #1



Fig. #2



Fig. #3



Fig. #4



Fig. #5



See page 214
for the complete
CADDY® CABLECAT
Capacity Guide

Metal Screws

Features

- For CADDY® CABLECAT Wide Base Cable Support.

Part Number	Description	Standard Packaging Quantity
S3575BP100	1/4- 20 x 3/8" round head screw	100
S3575DP100	1/4- 20 x 3/4" round head screw	100

CADDY® CABLECAT

Wide Base Cable Support Clips -
3/4" Diameter Loop



Part Number	Fig. #	Description	Standard Packaging Quantity
CAT124Z34	1	3/4" J-Hook assembled to 4Z34 - #12 thru 1/4" wire, plain or threaded rod and 1/8" thru 3/8" flange	40
CAT126Z34	1	3/4" J-Hook assembled to 6Z34 - 3/8" plain or threaded rod and 3/8" thru 7/16" flange	60
CAT12TS	2	3/4" J-Hook assembled to Acoustical tee bar bracket	60
CAT12AB	3	3/4" J-Hook assembled to angle bracket - 1/4" mounting hole	40
CAT12AFAB3	4	3/4" J-Hook assembled to Angle Bracket Assembly - 3/16" mounting hole	40
CAT12VF14	5	3/4" J-Hook assembled to C purlin bracket - 1/16" thru 1/4" vertical flange	40
CAT12912SM	6	3/4" J-Hook assembled to hammer-on 1/2" thru 3/4" flange - side mount	40
CAT12912	7	3/4" J-Hook assembled to hammer-on 1/2" thru 3/4" flange - bottom mount rotates 360°	20
CAT1224SM	6	3/4" J-Hook assembled to hammer-on 1/8" thru 1/4" flange - side mount	40
CAT1224	7	3/4" J-Hook assembled to hammer-on 1/8" thru 1/4" flange - bottom mount rotates 360°	40
CAT1258SM	6	3/4" J-Hook assembled to hammer-on 5/16" thru 1/2" flange - side mount	40
CAT1258	7	3/4" J-Hook assembled to hammer-on 5/16" thru 1/2" flange - bottom mount rotates 360°	40
CAT12BC	8	3/4" J-Hook assembled to screw-on bracket - 1/8" thru 1/2" flange	40
CAT12BC200	9	3/4" J-Hook assembled to screw-on bracket - 1/8" thru 5/8" flange	40
CAT12BC200B	10	3/4" J-Hook assembled to screw-on bracket - 1/8" thru 5/8" flange - rotates 360°	40
CAT12BCB	8	3/4" J-Hook assembled to screw-on bracket 1/8" thru 1/2" flange - rotates 360°	40
CAT12CD1B	11	3/4" J-Hook assembled to under floor support to pedestal	40
CAT12AF14	12	3/4" J-Hook assembled to Z purlin bracket - 1/16" thru 1/4" Z purlin	40
CAT12ESC	13	Snap-in 3/4" Diameter J-Hook	60





Fig. #1



Fig. #2



Fig. #3



Fig. #4



Fig. #5



Fig. #6



Fig. #7



Fig. #8



Fig. #9



Fig. #10



Fig. #11



Fig. #12



Fig. #13

See page 214
for the complete
CADDY® CABLECAT
Capacity Guide

CADDY® CABLECAT

Wide Base Cable Support Clips
- 1 5/16" Diameter Loop



Part Number	Fig. #	Description	Standard Packaging Quantity
CAT214Z34	1	1-5/16" J-Hook assembled to 4Z34 - #12 thru 1/4" wire, plain or threaded rod and 1/8" thru 3/8" flange	40
CAT216Z34	1	1-5/16" J-Hook assembled to 6Z34 - 3/8" plain or threaded rod and 3/8" thru 7/16" flange	60
CAT21AB	2	1-5/16" J-Hook assembled to angle bracket - 1/4" mounting hole	40
CAT21AFAB3	3	1-5/16" J-Hook assembled to Angle Bracket Assembly - 3/16" mounting hole	40
CAT21AFAB4	3	1-5/16" J-Hook assembled to Angle Bracket Assembly - 1/4" mounting hole	40
CAT21AFAB6	3	1-5/16" J-Hook assembled to Angle Bracket Assembly - 3/8" mounting hole	40
CAT21VF14	4	1-5/16" J-Hook assembled to C purlin bracket - 1/16" thru 1/4" vertical flange	40
CAT21912SM	5	1-5/16" J-Hook assembled to hammer-on 1/2" thru 3/4" flange - side mount	40
CAT21912	6	1-5/16" J-Hook assembled to hammer-on 1/2" thru 3/4" flange - bottom mount rotates 360°	20
CAT2124SM	5	1-5/16" J-Hook assembled to hammer-on 1/8" thru 1/4" flange - side mount	40
CAT2124	6	1-5/16" J-Hook assembled to hammer-on 1/8" thru 1/4" flange - bottom mount rotates 360°	40
CAT2158SM	5	1-5/16" J-Hook assembled to hammer-on 5/16" thru 1/2" flange - side mount	40
CAT2158	6	1-5/16" J-Hook assembled to hammer-on 5/16" thru 1/2" flange - bottom mount rotates 360°	40
CAT21BC	7	1-5/16" J-Hook assembled to screw-on bracket - 1/8" thru 1/2" flange	40
CAT21BC200	8	1-5/16" J-Hook assembled to screw-on bracket - 1/8" thru 5/8" flange	40
CAT21BC200B	9	1-5/16" J-Hook assembled to screw-on bracket - 1/8" thru 5/8" flange - rotates 360°	40
CAT21BCB	7	1-5/16" J-Hook assembled to screw-on bracket 1/8" thru 1/2" flange - rotates 360°	40
CAT21CD1B	10	1-5/16" J-Hook assembled to under floor support to pedestal	40
CAT21AF14	11	1-5/16" J-Hook assembled to Z purlin bracket - 1/16" thru 1/4" Z purlin	40
CAT21ESC	12	Snap-in 1 5/16" Diameter J-Hook	60





Fig. #1



Fig. #2



Fig. #3



Fig. #4



Fig. #5



Fig. #6



Fig. #7



Fig. #8



Fig. #9



Fig. #10



Fig. #11



Fig. #12

See page 214
for the complete
CADDY® CABLECAT
Capacity Guide

CADDY® CABLECAT

Wide Base Cable Support Clips -
2" Diameter Loop



Part Number	Fig. #	Description	Standard Packaging Quantity
CAT324Z34	1	2" J-Hook assembled to 4Z34 - #12 thru 1/4" wire, plain or threaded rod and 1/8" thru 3/8" flange	40
CAT326Z34	1	2" J-Hook assembled to 6Z34 - 3/8" plain or threaded rod and 3/8" thru 7/16" flange	40
CAT32AB	2	2" J-Hook assembled to angle bracket - 1/4" mounting hole	40
CAT32AFAB3	3	2" J-Hook assembled to Angle Bracket Assembly - 3/16" mounting hole	40
CAT32AFAB4	3	2" J-Hook assembled to Angle Bracket Assembly - 1/4" mounting hole	40
CAT32AFAB6	3	2" J-Hook assembled to Angle Bracket Assembly - 3/8" mounting hole	40
CAT32VF14	4	2" J-Hook assembled to C purlin bracket - 1/16" thru 1/4" vertical flange	40
CAT32912SM	5	2" J-Hook assembled to hammer-on 1/2" thru 3/4" flange - side mount	40
CAT32912	6	2" J-Hook assembled to hammer-on 1/2" thru 3/4" flange - bottom mount rotates 360°	20
CAT3224SM	5	2" J-Hook assembled to hammer-on 1/8" thru 1/4" flange - side mount	40
CAT3224	6	2" J-Hook assembled to hammer-on 1/8" thru 1/4" flange - bottom mount rotates 360°	20
CAT3258SM	5	2" J-Hook assembled to hammer-on 5/16" thru 1/2" flange - side mount	40
CAT3258	6	2" J-Hook assembled to hammer-on 5/16" thru 1/2" flange - bottom mount rotates 360°	20
CAT32BC	7	2" J-Hook assembled to screw-on bracket - 1/8" thru 1/2" flange	40
CAT32BC200	8	2" J-Hook assembled to screw-on bracket - 1/8" thru 5/8" flange	20
CAT32BC200B	9	2" J-Hook assembled to screw-on bracket - 1/8" thru 5/8" flange - rotates 360°	20
CAT32BCB	7	2" J-Hook assembled to screw-on bracket 1/8" thru 1/2" flange - rotates 360°	20
CAT32CD1B	10	2" J-Hook assembled to under floor support to pedestal	20
CAT32AF14	11	2" J-Hook assembled to Z purlin bracket - 1/16" thru 1/4" Z purlin	40
CAT32ESC	12	Snap-in 2" Diameter J-Hook	40





Fig. #1



Fig. #2



Fig. #3



Fig. #4



Fig. #5



Fig. #6



Fig. #7



Fig. #8



Fig. #9



Fig. #10



Fig. #11



Fig. #12

See page 214
for the complete
CADDY® CABLECAT
Capacity Guide

CADDY® CABLECAT

Wide Base Cable Support Clips -
4" Diameter Loop



Part Number	Fig. #	Description	Standard Packaging Quantity
CAT64AFAB3	1	4" J-Hook assembled to Angle Bracket Assembly - 3/16" mounting hole	25
CAT64AFAB4	1	4" J-Hook assembled to Angle Bracket Assembly - 1/4" mounting hole	25
CAT64AFAB6	1	4" J-Hook assembled to Angle Bracket Assembly - 3/8" mounting hole	25
CAT64VF14	2	4" J-Hook assembled to C purlin bracket - 1/16" thru 1/4" vertical flange	25
CAT64912SM	3	4" J-Hook assembled to hammer-on 1/2" thru 3/4" flange - side mount	25
CAT64912	4	4" J-Hook assembled to hammer-on 1/2" thru 3/4" flange - bottom mount rotates 360°	25
CAT6424SM	3	4" J-Hook assembled to hammer-on 1/8" thru 1/4" flange - side mount	25
CAT6424	4	4" J-Hook assembled to hammer-on 1/8" thru 1/4" flange - bottom mount rotates 360°	25
CAT6458SM	3	4" J-Hook assembled to hammer-on 5/16" thru 1/2" flange - side mount	25
CAT6458	4	4" J-Hook assembled to hammer-on 5/16" thru 1/2" flange - bottom mount rotates 360°	25
CAT64BC	5	4" J-Hook assembled to screw-on bracket - 1/8" thru 1/2" flange	25
CAT64BC200	6	4" J-Hook assembled to screw-on bracket - 1/8" thru 5/8" flange	25
CAT64BC200B	7	4" J-Hook assembled to screw-on bracket - 1/8" thru 5/8" flange - rotates 360°	25
CAT64BCB	5	4" J-Hook assembled to screw-on bracket 1/8" thru 1/2" flange - rotates 360°	25
CAT64CD1B	8	4" J-Hook assembled to under floor support to pedestal	25
CAT64AF14	9	4" J-Hook assembled to Z purlin bracket - 1/16" thru 1/4" Z purlin	25





Fig. #1



Fig. #2



Fig. #3



Fig. #4



Fig. #5



Fig. #6



Fig. #7



Fig. #8



Fig. #9

See page 214
for the complete
CADDY® CABLECAT
Capacity Guide

CADDY® CABLECAT Pulley

Features

- CAT32PLR accepts up to 20 four-pair cables
- Complies with the TIASM standard requirement by minimizing the pull force on the cable
- Frees up the “second man” on cable pulling
- Kit includes spring-loaded J-hook, pin, wheel and retainer, link, and beam clamp
- Maintains proper bend radius and protects cable during the installation
- When the job is complete, the pulley and pin assembly can be removed leaving the J-hook as a cable support
- CAT64PLR accepts up to 40 four-pair cables
- The CAT32PLR pulley components can be used on original design CAT32 J-hook
- The CAT64PLR pulley components can be used on original design CAT64 J-hook



Part Number	Description	Standard Packaging Quantity
CAT32PLR	Pulley kit - CAT32 2" spring-loaded J-hook, pin, wheel and retainer, link and beam clamp	10
CAT64PLR	Pulley kit - CAT64 4" spring-loaded J-hook, pin, wheel and retainer, link and beam clamp	2



CADDY® CABLECAT

Vertical Backbone Cable Support

Features

- Makes vertical cable pulling easier - locking mechanism opens during pull and re-engages when cable is released
- Accepts wide range of cable sizes: (75) 4-pair UTP CAT5E, (47) CAT6, (10) 25-pair UTP, (1) each 100-pair through 600-pair.
- Available as wall-mount (#CAT600WM) or strut-mount (#CAT600R)*
- Strut-mount includes pre-riveted assembly that twist-locks into the strut
- Rounded edges help prevent cable damage
- Valuable space savings within telecomm closets
- More versatile allowing future additions of cable runs
- Reduces installation time
- Allows cable installation to start at the bottom floor
- Galvanized finish for corrosion protection



Fig. #1



Fig. #2



Part Number	Fig. #	Description	Standard Packaging Quantity
CAT600R	1	Vertical Cable Support - Strut mount	2
CAT600WM	2	Vertical Cable Support - Wall mount	2
CAT600RKIT	1	Vertical Cable Support - Strut mount kit with (1) 18" precut slotted strut & (4) CAT600R	1

See page 214
for the complete
CADDY® CABLECAT
Capacity Guide

Adjustable Cable Support



Features

- Up to 425 4-pair UTP or 2-strand fiber optic cable, or 265 CAT6 - 4" or 6" dia. loop
- Provides proper support of Category 5e, Category 6, fiber optic and innerduct
- Multiple sizes and designs available to attach to a variety of structures
- Cost effective alternative to expensive cable tray
- cULus® listed and complies with NEC® and TIASM requirements for structured cabling systems
- Suitable for air handling spaces (plenum)

Part Number	Fig. #	Description	Standard Packaging Quantity
Adjustable Cable Support			
CAT425	1	Adj. Cable Support for use with 1/4" Threaded rod or horizontal surface	10
CAT425A6	2	Adj. Cable Support with 3/8" Threaded rod or horizontal surface	10
CAT425WM	3	Adj. Cable Support with Wall mount - vertical surface	10
Beam Clamp			
CAT425BC	4	Adj. Cable Support with Screw-on 1/8" - 1/2" flange (rotates 360°)	10
CAT425BC200	5	Adj. Cable Support with Screw-on 1/8" - 5/8" flange (rotates 360°)	10
Hammer on Flange Clip			
CAT42524SM	6	Adj. Cable Support with Hammer-on 1/8" - 1/4" flange	10
CAT42558SM	6	Adj. Cable Support with Hammer-on 5/16" - 1/2" flange	10
CAT425912SM	6	Adj. Cable Support with Hammer-on 9/16" - 3/4" flange	10
Purlin			
CAT425AF14	7	Adj. Cable Support with Hammer-on 1/16" - 1/4" Z purlin	10
CAT425VF14	8	Adj. Cable Support with Hammer-on 1/16" - 1/4" vertical flange	10
CAT425WMCD1B	9	Adj. Cable Support with Under floor pedestal	10





Fig. #1



Fig. #2



Fig. #3



Fig. #4



Fig. #5



Fig. #6



Fig. #7



Fig. #8



Fig. #9

See page 214
for the complete
CADDY® CABLECAT
Capacity Guide

CADDY® CAT CM

Features

- Specially designed U-Hooks and double J-Hooks have large- diameter, rounded support surfaces/edges to avoid over-bending and kinking of cables
- Cable support system offering unprecedented installation flexibility
- Compliant with NEC® and ANSI®/TIASM structured cabling systems standards
- Hooks are cULus® listed
- Convenient pathway for wires and cables
- Rod-Mounted allows for field assembly onto All-Thread Rod
- Cantilever-Mounted allows U-hooks to be mounted with brackets to walls and columns



Part Number	Fig. #	Description	Standard Packaging Quantity
CAT100CM	1	Double J-Hook	20
CAT200CM*	2	U-Hook 200 mm/8" with T-nut	10
CAT200CMLN	2	U-Hook 200 mm/8" less nut	10
CAT300CM*	2	U-Hook 300 mm/12" with T-nut	10
CAT300CMLN	2	U-Hook 300 mm/12" less nut	10
CATRL200CM	3	Roller 200 mm/8" (incl. rod & nuts)	10
CATRL300CM	3	Roller 300 mm/12" (incl. rod & nuts)	10
CATRT200CM	4	Wire Retainer 200 mm/8"	50
CATRT300CM	4	Wire Retainer 300 mm/12"	50
CATTBCM	5	Protection Tube	30
CATWCM	6	Wall Bracket	10

*Quick-Attach T-nut for HALFSLOT Strut

CABLE	CAT100CM ON ROD	CAT200CMLN ON ROD OR CANTILEVER	CAT300CMLN ON ROD OR CANTILEVER
4-pair UTP, Cat 5/5e	80	500	750
4-pair UTP, Cat 6	50	315	470
4-pair ScTP/FTP	40	250	375
4-pair STP	26	170	250
Area (sq. in.)	2 x 1.58	21.00	32.00





Fig. #1



Fig. #2



Fig. #3



Fig. #4



Fig. #5



Fig. #6

See page 214
for the complete
CADDY® CABLECAT
Capacity Guide

Multi-Purpose Clip

Features

- Requires only a hammer to install
- Accommodates any beam flange from 1/8" to 1/2" thickness
- Accommodates standard 1/4-20 or #10-24 threaded bridle rings, standard drive rings as well as unthreaded bridle rings
- Supports drive rings or bridle rings from flange



Fig. #1

Part Number	Fig. #	Description	Standard Packaging Quantity
2FMP28	1	Multi-purpose clip that accommodates beam flange from 1/8" to 1/2"	100

Note: Drive rings not available from ERICO



Cable Gripper

Features

- Attaches to existing holes in metal studs without tools or with Metal Stud Punch (MSP20)
- Delivers compliance with: NEC® 300.4(d), CEC 12-510 and 12-516
- Installs easily to metal and wood studs
- Provides secure installation of multiple cables with unique locking/unlocking system
- Staples, nails or screws to wood stud
- Supports four NMC or eight 4-pair UTP, Category 5 and higher (electrical and datacomm cannot be combined)



Patent Number:
5,626,316



Part Number	Description	Bag Qty
CG4	Cable Gripper cable support	100



Refer to part number
MSP20 for the Metal
Stud Punch

Plain, Threaded And Wood Screw Bridle Rings

Features

- When combined with other CADDY® Fasteners, Bridle Rings can be located on:
- "C" Purlins – VF144TI.
- "Z" Purlins – 1224TI or AF144TI.
- Acoustical T-Grid – ATS4I or ATA4I.
- Beam Flanges up to 3/4" – 2FMP28, BC, BC200, M912.
- Concrete – 4TIB.
- Drop Wire – 4Z34 - 6Z34.



Fig. #1

Part Number	Fig. #	Description	Standard Packaging Quantity
2BR8	1	Bridle ring 1/2" dia. #8 wire	100
2BR12	1	Bridle ring 3/4" dia. #8 wire	100
2BR20	1	Bridle ring 1-1/4" dia. #8 wire	100
2BR32	1	Bridle ring 2" dia. #8 wire	100
2BRT8	2	Bridle ring 1/2" dia. 10-24 threaded	100
2BRT12	2	Bridle ring 3/4" dia 10-24 threaded	100
2BRT20	2	Bridle ring 1-1/4" dia. 10-24 threaded	100
2BRT32	2	Bridle ring 2" dia. 10-24 threaded	100
4BRT20	2	Bridle Ring 1-1/4" dia. 1/4-20 threaded	100
4BRT32	2	Bridle Ring 2" dia. 1/4-20 threaded	100
4BRT64	2	Bridle Ring 4" dia. 1/4-20 threaded	50
4BRT20WS	3	Bridle Ring 1-1/4" dia. #14 wood screw thread	100
4BRT32WS	3	Bridle Ring 2" dia. #14 wood screw thread	100

Notes: Bridle Rings not recommended for high performance cables, see CADDY® CABLECAT series.



Fig. #2



Fig. #3



CADDY® Mille-Tie™

Features

- Suitable for heavy duty applications
- Maintains cable properties and conductor configuration
- Protects cable from crimping with "Intelligent Grip Technology"
- Cushions vibration
- No sharp edges
- One size fits all
- Reusable



Fig. #1

Part Number	Fig. #	Description	Standard Packaging Quantity
CATMTLS	1	Yellow CADDY Mille-Tie (Low Smoke - Zero Halogen)	1,000
CATMTP	2	Red CADDY Mille-Tie (suitable for air-handling spaces)	1,000
CATMTH	3	CADDY Mille-Tie Heavy Duty (Black)	100



Fig. #2



Fig. #3

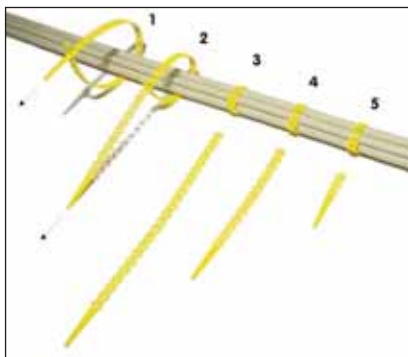

CADDY® CAT CR50 Cable Retainer



Features

- Allows for horizontal and vertical change of direction
- Complies with the NEC®, the CEC and TIASM standards
- Installs easily\works with CAT 5e and higher, fiber optic and coaxial cable
- Residential Application
- Suitable for air-handling spaces (plenum rating)



Part Number	Description	Standard Packaging Quantity
CATCR50	Cable Retainer 50 mm, 2" dia.	25



See page 214
for the complete
CADDY® CABLECAT
Capacity Guide



Mille-Tie is a trademark of Millepede International, Ltd.

Camera, alarm and speaker hanging support solutions

Features

- Reduces installation time
- Securely fastens cameras to various building structures
- Complies with codes and best practices



Fig. #1

Part Number	Fig. #	Description	Standard Packaging Quantity
SCMKB	1	Security Camera Mounting Kit - Beam	20
SCMKC	2	Security Camera Mounting Kit - Between T-grid	20
SCMKT	3	Security Camera Mounting Kit - T-grid	20
SCMKW	4	Security Camera Mounting Kit - Wall Mount	20



Fig. #2



Fig. #3



Fig. #4



CADDY® LINIAN Clip

Features

- After the hole is drilled, no tools are required for installation
- Corrosion-resistant coating
- Easily fixes fire-resistant cables to brickwork, concrete, masonry, wood studs and wood beams
- Independently tested to resist tensile loads of up to 24 lbs
- Installs up to 70% faster than saddle clips



Fig. #1

Part Number	Fig. #	Description	Standard Packaging Quantity
LI1	1	Cable clip for coax, control & alarm cable and speaker wire (6 to 8 mm)	100
LI2	1	Cable clip for coax, control & alarm cable and speaker wire (9 to 11 mm)	100
LI1B	2	Cable clip for coax, control & alarm cable and speaker wire (6 to 8 mm)	100
LI2B	2	Cable clip for coax, control & alarm cable and speaker wire (9 to 11 mm)	100
LI1W	3	Cable clip for coax, control & alarm cable and speaker wire (6 to 8 mm)	100
LI2W	3	Cable clip for coax, control & alarm cable and speaker wire (9 to 11 mm)	100



Fig. #2



Fig. #3



Box Eliminator Conduit Support

Features

- Eliminates need for electrical box when datacomm cables are run in conduit
- Supports 3/4", 1" and 1-1/4" conduit
- Easily attaches to the MP15 or MP25 low voltage mounting plates
- MP1SCB & MP2SCB mounting plate kits include: mounting plate, conduit support and screws



Fig. #1

Part Number	Fig. #	Description	Standard Packaging Quantity
MP1SCB	1	Single Gang Box Eliminator Conduit Support (Includes: MP15, MP1SCB1220 and screws)	25
MP2SCB	2	Double Gang Box Eliminator Conduit Support (Includes: MP25, MP1SCB1220 and screws)	25
MPCB1220	3	Box Eliminator Conduit Support (with screws)	25



Fig. #2

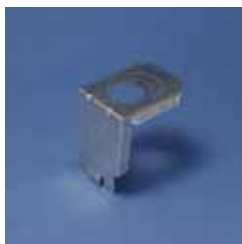

Fig. #3



Low Voltage Mounting Bracket For New Construction

Features

- Provides a bracket for mounting low voltage Class 2 communication outlets
- Reduces bulges in the dry wall caused by plaster rings
- May be installed to the front or the side of the metal or wood stud
- Side support provides for a rigid installation
- Attaches with self-tapping screws or nails
- Works with 1/2" and 5/8" dry wall
- Works with wood or metal studs



Fig. #1



Fig. #2

Notes: No Load Rating - Positioning Only

Part Number	Fig. #	Description	Standard Packaging Quantity
MP1S	1	Single gang plate mounting bracket for new work	25
MP2S	2	Double gang plate mounting bracket for new work	25



Mounting Plate Brackets (Metallic)

Screw-On Support

Features

- Provides positive support with locking screws
- Mounts any standard low voltage device in 1/2" through 1 1/4" walls
- Makes wire "fishing" easier
- Install with a drywall saw and screwdriver
- Eliminates the need for an electrical box when installing low voltage Class 2 wiring



Fig. #1

Notes: For low voltage Class 2 use only.

Part Number	Fig. #	Description	Standard Packaging Quantity
MP1	1	Single gang Mounting Plate Brackets (no screws included)	100
MPLS	2	Single gang Mounting Plate Brackets screws to drywall (screws included)	100
MPLS2	3	Double gang Mounting Plate Brackets screws to drywall (screws included)	100



Fig. #2



Fig. #3

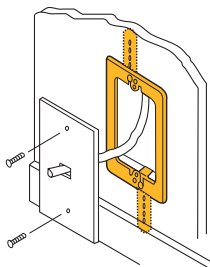

Within Wall Mounting Plate

MP1WWM

Features

- Unique installation eliminates excess movement
- Fits any drywall thickness
- Designed to eliminate gaps between the wall and faceplate
- Highly visible yellow material helps prevent incorrect installation
- Template dimples on the bracket provide measurement markings for simplified installation
- Securing pins lock the plate into the drywall
- Convenient removable tether assists with positioning
- cULus® Listed



Part Number	Description	Standard Packaging Quantity
MP1WWM	Within Wall Mounting Plate	100



Mounting Plate Brackets (Non-Metallic)

Features

- No sharp metal edges with plastic design
- Fast, easy way to install
- No installation tools required to secure bracket in the drywall opening
- Serrated interlocking system secures tightly
- Template points on brackets help eliminate multiple measurement markings during installation
- Recessed design helps assure flush mount of device
- Only CADDY® provides the industry with the widest application range 1/4" to 1 1/4" wall thickness
- Available in single gang, double gang and a unique 3-4 gang sizes
- Eliminates the need for electrical boxes on low voltage class 2 applications



Fig. #1

Notes: For low voltage Class 2 use only.

No Load Rating - Positioning Only

Part Number	Fig. #	Description	Standard Packaging Quantity
MP1P	1	Non-Metallic Single gang mounting plate	100
MPAL2	2	Non-Metallic double gang mounting plate	100
MP34P	3	Non-Metallic 3 or 4 gang mounting plate	2



Fig. #2



Fig. #3



Metal Stud Punch And Easy Snap Grommet

Features

- Cushioned handles mean less operator fatigue and more comfortable handling
- Tool design with offset handles allows punch to work in confined locations and near perpendicular walls
- Lightweight punch makes accurate location of holes easier
- Hardened steel components keep tool sharper longer – less replacement
- Punches up to 20 gauge sheet metal
- Plastic grommets snap easily into 1-11/32" hole



Fig. #1



Part Number	Fig. #	Description	Standard Packaging Quantity
MSP20	1	Metal Stud Punch	1

Features

- Snap one grommet into standard 1-11/32" field punched hole, OR snap tight two together into any shape factory punched hole
- Provides 360° protection for cable and makes cable pulls easier



Fig. #2

Part Number	Fig. #	Description	Standard Packaging Quantity
ESG1	2	Metal Stud Grommet	100
ESG1M	2	Metal Stud Grommet	1,000
ESGP	3	Metal Stud Anti-Rattle Grommet	100



Fig. #3



Wire Basket Tray Clip











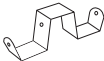

Features

- Attaches wire basket tray to strut without any additional hardware.
- Fits tray wires from 4mm to 8mm (3/16" to 5/16").
- No tools required.

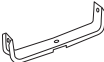

Part Number	Description	Standard Packaging Quantity
KBT	Wire Basket Tray Clip	1

- * For trays 300mm (12") or under use 2 clips per strut support.
- * For trays 457mm (18") or under use 3 clips per strut support.
- * For larger trays add one (1) clip per strut support for every 150mm (6") of tray width.
- * For positioning only (no load rating).

CADDY® CABLECAT Capacity Guide			
Area (sq. in.)	Capacity (4-pair)		Part Number
	Cat. 5e	Cat. 6	
0.60	16	10	CAT12 
2.16	50	32	CAT21 
3.17	80	50	CAT32 
2 x 1.58	80	50	CAT100CM 
15.28	300	220	CAT64 
20.43	425	265	CAT425 
21.00	500	315	CAT200CMLN 
32.00	750	470	CAT300CMLN 
3.14	75	47	CAT600 
1.07	25	15	CAT16HP 
3.97	95	60	CAT32HP 
9.26	220	140	CAT48HP 
15.48	380	230	CAT64HP 
2.67	50	36	CATCR50 



Acoustical/Ceiling/Partitions



Acoustical/Ceiling/Partitions

Seismic Fixture Clamp

Features

- Cost effective
- Reusable
- Secures fluorescent light fixtures to the ceiling frame members
- Requires no additional chains, cables or slack wires attached to the fixture
- Helps strengthen integrity of the T-Bar system
- Holds in place against the force of standard fire-hose pressure
- Meets U.S. building code and electrical code specifications
- Also satisfies NEC® 410.16(C) positive attachment for secure fastening of luminaires (fixtures) complying with Acceptance Criteria 184



Fig. #1

Part Number	Fig. #	Description	Standard Packaging Quantity
SFCLT	1	Seismic Fixture Lighting Clamp (set of 4) for one standard tapered 2' x 4' light fixture	100
SFCLTCF	2	Seismic Fixture Lighting Clamp (set of 2) for one 2' x 2' light fixture. In addition, a set of SFCLT is required	100
SFCLTCFS	3	Seismic Fixture Lighting Clamp (set of 2) for reinforcement of T-Bar main runner/cross runner connections	100
SFCLTE	2	Seismic Fixture Lighting Clamp (set of 2) for two standard tapered 2' x 4' light fixtures end-to-end. In addition, a set of SFCLT is required	50
SFCLTS	2	Seismic Fixture Lighting Clamp (set of 2) for two standard tapered 2' x 4' light fixtures side-by-side. In addition, a set of SFCLT is required	50



Fig. #2



Fig. #3



SFC required at each corner

Note: The Seismic Fixture Clamp has been tested for compliance to the UBC, NEC, NBC, and CEC as well as approved and listed with:

- Warnock Hersey (Listed)
- ETL (Listed)
- Certified to CSA C22.2 No. 9.0-96 Component Only
- ID: Seismic Fixture Clamp



ICBO standards are a copyright of the International Code Council.
ICC is a registered trademark of the International Code Council.
Warnock Hersey & ETL are listing marks of Intertek Testing Services, NA.

Acoustical/Ceiling/Partitions

Lay In And Troffer Light Fixture Support Clips

Features

- Complies with The National Electrical Code, Article 410.16 Means of Support
- Gives a positive method of securing troffers and lay-ins
- Fits round or rectangular head tee bar
- No tools required for installation
- 4 clips per fixture required per UL listing
- 515 For straight lip fixtures
- 515A For straight or upturned lip fixtures



Fig. #1

**Works On
New Taller
T-Grid!**



Part Number	Fig. #	Description	Standard Packaging Quantity
515	1	Straight lip fixtures	100
515A	2	Upturned or straight lip fixtures	100
515AWHA	2	Upturned or straight lip fixtures	100

Note: No load rating – Position only



Fig. #2



TGE Clip T-Grid Splicing Clip

Features

- Replaces pop riveting
- No need to cut and bend "T"
- Can be used to splice across "T" into the main "T"
- "T" to edge angle

Part Number	Description	Standard Packaging Quantity
TGE	Attaches tee to edge trim	100



Acoustical/Ceiling/Partitions

Electrical Component Supports

Features

- Provides a method of supporting conduit and outlet boxes above acoustical tee bar
- Available for both horizontal and vertical support
- Clips are available with 1/4-20 thread impression or plain hole
- Riveted assemblies accommodate MC/AC to 1" conduit
- No installation tools required for basic clip
- Additional support required per NEC 300.11



Fig. #3

Part Number	Fig. #	Side or Top Mounted	Description	Standard Packaging Quantity
12PATS	1	Side	for 3/4" conduit	100
16PATS	1	Side	for 1" conduit	100
8PATS	1	Side	to 1/2" conduit	100
12PATA	2	Top	for 3/4" conduit	100
16PATA	2	Top	for 1" conduit	100
8PATA	2	Top	for 1/2" conduit	100
ATA4I	3	Top	1/4-20 thread impression	100
ATS4I	4	Side	1/4-20 thread impression	100
16MATS	5	Side	for 1" conduit	100
6MATS	5	Side	for MC/AC cable	100
812MATS	5	Side	for 1/2" to 3/4" conduit	100
16MATA	6	Top	for 1" conduit	100
6MATA	6	Top	for MC/AC cable	100
812MATA	6	Top	for 1/2" - 3/4" conduit	100
MAC2ATA	7	Top	Acoustical Tee	100

Notes: No Load Rating - Positioning Only; Eliminates need for offset bending conduit; Additional support required per NEC 300.11



Fig. #1



Fig. #2



Fig. #4



Fig. #5



Fig. #6



Fig. #7



Acoustical/Ceiling/Partitions

Independent Support Clips

Features

- Provides a means of independent support of fixtures
- No tools required for installation
- Includes mounting hardware



Fig. #1

Static Load: 65 lbs.

Part Number	Fig. #	Grid Size (in)	Stud Length (in)	Standard Packaging Quantity
Stud: 1/4-20				
IDS	1	15/16	5/8	100
IDS15	1	15/16	1 1/2	100
IDS2	1	15/16	2	100
IDS9 ⁺	1	9/16	5/8	100
IDS95 ⁺	2	9/16 x 5/16	5/8	100
Stud: 8-32				
IDST ⁺	3	15/16	9/16	100
IDS9T ⁺	3	9/16	9/16	100
IDS95T ⁺	2	9/16 x 5/16	9/16	100

*For Ultra Line 3500, AWW Ultra Line 3600 (a trademark product of Chicago Metallics Corp.)

*For Fineline and Fineline 1/8" Grids (a trademark product of USG Interiors®, Inc.)

*Uses identical nuts as figure 3



**Works On
New Taller
T-Grid!**



Fig. #2



Fig. #3



Optional barrel nut:
order by adding -WB
suffix to part number
(IDSTWB)

Acoustical/Ceiling/Partitions

Snap On Fixture/ Box Hanger



Fig. #1

Features

- Snaps easily onto tee bar
- Hanger comes complete with box mounting clip and 1/4-20 screw
- Supports from acoustical tee bar as well as main structure with the use of a drop wire
- Dual height feature permits 1-1/2" deep electrical box to be mounted flush with tile or off-set 3/4" for plaster ring
- 512A is height adjustable up to 8" allowing you to install double deep boxes, speaker cases and emergency light fixtures above acoustical tee
- Not permitted for paddle fans

Part Number	Fig. #	Description	Standard Packaging Quantity
512	1	Electrical box hanger - 24" span	50
51212	1	Electrical box hanger - 12" span	50
51220	1	Electrical box hanger - 20" span	50
51230	1	Electrical box hanger - 30" span	50
512A	2	8" height adjustable - 24" span	50
512ATC*	2	8" height adjustable - 24" span	50
512TC*	1	Electrical box hanger - 24" span	50
CHB	3	Box mounting clip	100
CHBTC*	3	Box mounting clip	100
S102438BP50*	-	10-24 1/2" Round Head Robertson screw	50
S3575BP50	-	1/4-20 x 3/8" Round Head Screw	50

*For Canadian boxes

Notes: Not to exceed static load of 20 lbs. without independent wire support to CHB. CHB can be purchased separately when more than one box is required. Screw furnished. One CHB mounting clip is included with each 512.



Fig. #2



Fig. #3



Acoustical/Ceiling/Partitions

T-Grid Box Hanger

Features

- Quickly mounts a box to T-grid
- Now height adjustable for various electrical box depths
- Installs by hand
- Drop wire for independent support from clip and/or bar
- Screws easily to tee bar for added stability
- Multiple box installations
- Double deep box installations
- 512HDXT Extension Brackets
- Not permitted for paddle fans



Fig. #1

Static Load: 50 lbs.

Part Number	Fig. #	Description	Standard Packaging Quantity
510HD	1	Box mounting clip can be purchased separately for multiple box requirements	100
510HDTC*	2	Box mounting clip can be purchased separately for multiple box requirements	100
512HD†	1	Heavy-duty electrical box hanger with box mounting clip – 24" span	25
512HDEEP†	1	Heavy-duty electrical box hanger with extension bracket – 3 5/8" height	25
512HDEEPTC*	1	Heavy-duty electrical box hanger with extension bracket – 3 5/8" height	25
512HDTC*	1	Heavy-duty electrical box hanger with box mounting clip – 24"	25
512HDXT†	3	Extension bracket 3 5/8" height (25 sets)	50

*For Canadian boxes

†Tall grid compatible.

Notes: 512HD Series Standard bar mounts 2-1/8" box – break off tabs for 1-1/2" deep box. Mounts flush with face of tile.

512HDEEP Series with additional 512HDXT mounts 2-1/8" deep box with 1-1/2" extension ring.

One 510HD box mounting clip is included with each 512HD and 512HDEEP.



Fig. #2



Fig. #3



Acoustical/Ceiling/Partitions

Fan/Fixture Mount

Features

- 2-1/8" electrical box is pre-mounted and centered on bracket and is fully adjustable up to 8" in either direction
- Electrical box has three open knockouts for quick installation
- Each kit includes:
 - Screws to mount fan
 - CADDY® SPEED LINK to support from building structure
 - Two Fixture Mount Stabilizer Clips (FMSBC1) to stabilize ceiling tiles
- UL® Listed



Fig. #1



Fig. #2

Part Number	Fig. #	Description	Load Rating		Standard Packaging Quantity
			Fan	Fixture	
512HDFM35	1	Heavy Duty Fan/Fixture Support	35 lbs	50 lbs	1
512HDFM70	2	Heavy Duty Fan/Fixture Support	70 lbs	90 lbs	1



Acoustical/Ceiling/Partitions

Fixture Mount Stabilizer Clip



Features

- Levels signage
- Secures ceiling tile during installation of trim rings
- Helps eliminate bulges in ceiling tiles
- Works with square or hex-shaped electrical boxes
- Can be used on boxes with or without plaster rings
- No installation tools required
- Patent pending design
- Easy to adjust and maintains shape after installation

Part Number	Description	Standard Packaging Quantity
FMSBC1	Fixture Mount Stabilizer Clip (FMSBC1)	100



Acoustical/Ceiling/Partitions

Suspension Bar For Light Fixtures 517 Series

Features

- Reduces installation time
- No tools required for installation
- End clips rotate for mounting horizontal or vertical base plates
- Position of fixture is adjustable, simply slide to location
- No center clips required
- Span adjustable 11" to 26"

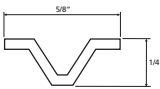
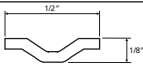
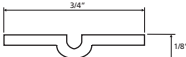

**Works On
New Taller
T-Grid!**

Part Number	Replacement Bar Type	Light Fixtures
517A	 to Standard 5/8" x 1/4"	CAPRI PR-751CX; CAPRI R-10C; CAPRI R-10X; CAPRI R-9X; HALO H17; JUNO AP; JUNO APT; JUNO IC; JUNO ICT; JUNO J; JUNO SC; JUNO TC; THOMAS RI-IC
517FCA		
517B	 to Narrow 1/2" x 1/8"	CAPRI HSG; HALO H7; LIGHTOLIER 711
517FCB		
517C	 to Wide 3/4" x 1/8"	MARCO; Progress P-7
517FCC		

Notes: Applicable to a wide variety of light fixtures.; Measure width of bar to find appropriate bar for fixture.; No Load Rating - Positioning Only; The 517 series bar replaces the fixture bar.

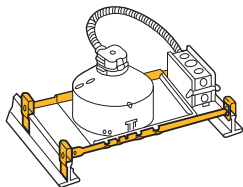

T-Grid Applications

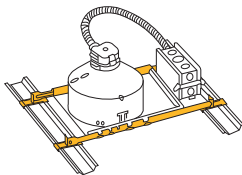

Hat Channel Applications

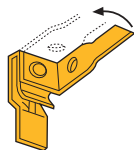

End clips rotate for mounting horizontal or vertical base plates



Acoustical/Ceiling/Partitions

Suspension Bars For Lightolier® Calculite® Series Fixtures



Features

- Reduces installation time
- Only a screwdriver required
- Position of fixture is adjustable with span

Note: No Load Rating - Positioning Only

Part Number	Description	Standard Packaging Quantity (Set)
520	Suspension bars for Lightolier Calculite series fixtures	10

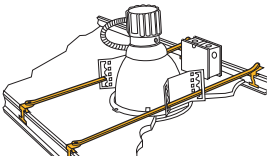

Lightolier and Calculite are registered trademarks of Lightolier, a GENLYTE Company.

“Twist On” Track Light Clips

Features

- Fast, easy installation
- No special tools required
- Will not damage T-bars
- Available in white finish
- Nut included – standard pal nut
For brass hex nut add WB to part number (2G9WB)

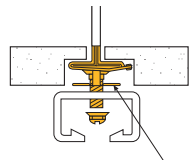

Static Load: 25 lbs

Spacer

Part Number	Description	Surface Finish	Stud Length (in)	Standard Packaging Quantity
2G9	For 9/16" tee	Silver	7/16	100
2G9S10	For 9/16" tee	Silver	5/8	100
4G8	For 15/16" tee	Silver	5/8	100
4G8S7	For 15/16" tee	Silver	7/16	100
4G8S7WH	For 15/16" tee	White	7/16	100
4G8WH	For 15/16" tee	White	5/8	100

Acoustical/Ceiling/Partitions

"Twist On" Fixture Support

Features

- Supports electrical fixtures from acoustical tee bar 9/16", 15/16" or 1-1/2" wide
- 1/4-20 stud – 5/8", 1-1/2", 2" or 3" long
- Washer-wing nut (4WN) included
- No tools required for installation



Fig. #1

Part Number	Fig. #	Description	Static Load (lbs)	Stud Length (in)	Standard Packaging Quantity
4TGS*	1	For recess T-grid system	25	1/4	100
4G24	2	For 1 1/2" tee with 4WN	40	5/8	100
4G16H	3	For 15/16" tee	40	1	100
4G16	4	For 15/16" tee with 4WN	50	5/8	100
4G1615	4	For 15/16" tee with 4WN	50	1 1/2	100
4G162	4	For 15/16" tee with 4WN	50	2	100
4G163	4	For 15/16" tee with 4WN	50	3	100
4G9	4	For 9/16" tee	40	5/8	100

*4TGS: To be used with studded Twist Clips



Fig. #2



Fig. #3



Fig. #4



Acoustical/Ceiling/Partitions

Lock-On Twist Clip

Features

- Attaches easily to tee bar
- Doesn't harm acoustical tee
- Fits 15/16" tee bar
- Provides "positive lock" to position fastener
- 4WN washer wing nut included



Fig. #1

Part Number	Fig. #	Description	Static Load	Standard Packaging Quantity
PT16	1	Lock-on twist clip for 15/16" tee, 3/4" stud	50	100
PT16FP	1	With felt pad	50	100
PT16SPCR	2	Plastic spacer for PT16	N/A	100

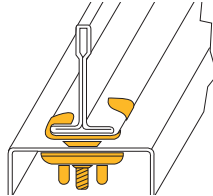

Fig. #2

Conduit Clip

Features

- Secure 1/2", 3/4", 1", 1-1/4" thin wall conduit to 1-1/2" lathers channel
- No tools required for installation



Static Load: 50 lbs

(When conduit hangs below lathers channel)

Part Number	Description
8D15L	1/2" EMT Conduit to 1-1/2" lathers channel
12D15L	3/4" EMT conduit to 1-1/2" lathers channel
16D15L	1" EMT conduit to 1-1/2" lathers channel
20D15L	1-1/4" EMT conduit to 1-1/2" lathers channel

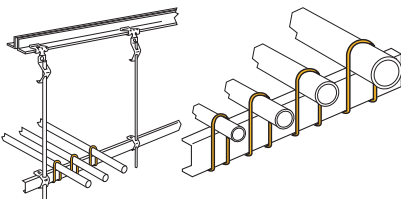

Acoustical/Ceiling/Partitions

Fluorescent Light Fixture Hanger

Features

- Provides an easy method of supporting an industrial class fluorescent light fixture from S-Hooks and Jack Chain.
- Fits most fluorescent light fixtures.
- Reduces the need to modify Jack Chain for fixture installation.
- Requires no special tools for installation.



Fig. #1

Static Load: 50 lbs.

Part Number	Fig. #	Description	Standard Packaging Quantity
LFC	1	Side mount clip	100
LFC90	2	Top mount clip	100



Fig. #2



Jack Chain And S-Hooks

Static Load: 29 lbs.

Part Number	Description	Standard Packaging Quantity
770	#12 Jack Chain 100 ft	1
771	#11 S-Hooks	50



Acoustical/Ceiling/Partitions

Independent Electrical Drop Wire/Rod Securing Clip



Fig. #1

Features

- Helps prevent sway of dedicated electrical drop wire/rod
- Will not affect ceiling grid systems negatively
- No tools required for installation. Forgiving design doesn't require exact cutting of rod/wire
- Painted yellow for easy identification by the inspector

Part Number	Fig. #	Description	Standard Packaging Quantity
EC311	1	Electrical drop wire securing clip #12 thru #8 wire	100
EC3114Z34	2	#12 wire thru 1/4" threaded rod	100
EC3116Z34	2	3/8" threaded rod	100
EC311P	3	Plastic electrical drop wire securing clip #12 thru #8 wire	100

Notes: Consult local authority for application approval.
Refer to NEC 300.11



Fig. #2



Fig. #3

**Works On
New Taller
T-Grid!**



Acoustical/Ceiling/Partitions

Adjustable Box And Conduit Support (DFN)

Features

- Supports boxes and conduit above acoustical T-bar with adjustments from 4-1/4" through 7-1/4"
- Allows attachment of conduit clips with thread impressions at required height
- No tools required for installation



Fig. #1

No Load Rating - Positioning Only

Part Number	Fig. #	Description	Conduit Size (in)	Standard Packaging Quantity
528	1	Adjustable box and conduit support (DFN)	-	50
52812P	2	Tee-bar rivet to hanger assembly 3/4" EMT	For 3/4 EMT	25
52816P	2	Tee-bar rivet to hanger assembly 1" EMT	For 1 EMT	25
5288P	2	Tee-bar rivet to hanger assembly 1/2" EMT	For 1/2 EMT	25

Note: Comes with P-series with THD impression screw assembled to top hole location (adjustable).



Fig. #2

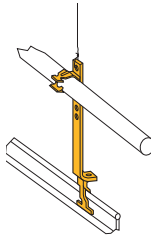

Additional support wire required per NEC 300.11



Conduit/Box Support



Features

- Provides a method for attaching above acoustical tee bars
- Provided with 1/4-20 screw for attachment to tee bar
- Has a 1/4-20 thread impression for direct attachment to an outlet box or conduit clips
- When used in combination with a conduit clip and outlet box, it provides exact alignment – eliminating an offset bend in the conduit

Part Number	Description	Standard Packaging Quantity
4ACS	Conduit/box support on T-grids	100

Works On
New Taller
T-Grid!

Notes: Consult local authority for application approval; Not to be used to hang Tee Grid

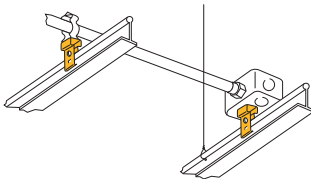

Acoustical/Ceiling/Partitions

Lathers Channel Hanger

- Attaches 1-1/2" lathers channel to #8 wire, 1/4" plain rod
- Attaches 2" lathers channel to 1/4" plain rod
- Available in both center and sidemount for 1/4" rod
- Provides pre-leveling of channel
- Will fit channel flange widths 7/16" thru 5/8"
- No tools required for installation

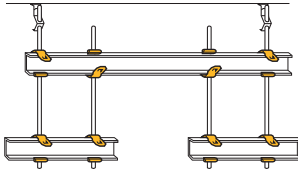

Fig. #1

Part Number	Fig. #	Description	Static Load Limit (lbs)	Standard Packaging Quantity
2B15LS	1	#8 Wire to 1-1/2" lathers channel side mount	160	100
4B15LS	1	1/4" Rod to 1-1/2" lathers channel side mount	160	100
4B2LS	1	1/4" Rod to 2" lathers channel side mount	160	100
4B15L	2	1/4" Rod to 1-1/2" lathers channel	200	100



Fig. #2



- Helps eliminate the major problem of cutouts for lighting layouts, ducts, obstructions and architectural changes
- Provides a method for attaching 1-1/2" channel to existing #8 wire, #9 wire, 3/16" or 1/4" plain rod, or 1/8"- 3/16" x 1" wide strap
- No tools required for installation



Fig. #3

Part Number	Fig. #	Description	Standard Packaging Quantity
HRL15A	3	Lathers Channel Hanger #9 and #8 wire- 3/16" and 1/4" plain rod; 1/8" and 3/16" thick strap (flange)	100

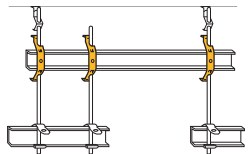

Acoustical/Ceiling/Partitions

Lathers to T-Grid Hanger Clip

Features

- Allows 6" drop space providing area for light fixtures
- Fits 1-1/2" channel with flange widths from 1/2" to 5/8"
- Installs quickly and easily



Fig. #1

Part Number	Fig. #	Description	Standard Packaging Quantity
LTGH	1	Provides 6" space in supporting acoustical tee from 1-1/2" lathers channel	100



Lathers Channel Box Mount

Features

- Provides attachment of conduit and outlet boxes directly to lathers channel with 1/4-20 x 3/4" screw furnished
- Can be applied to the top or bottom flange of the channel
- Fits most lathers channel 3/4", 1-1/2" and 2". Maximum flange width 5/8"



Part Number	Description	Standard Packaging Quantity
4LCB	Lathers channel box mount	100

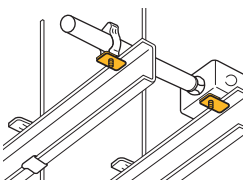

Eliminates offset bending conduit

Acoustical/Ceiling/Partitions

Support Box From Lathers Channel

Features

- Provides a convenient method of supporting an electrical box from 3/4" thru 2" lathers channel
- "One piece/two piece" construction helps prevent dropping of loose parts
- Built-in thread impressions eliminate the need for nuts
- Multiple pre-punched holes allow for box height adjustability and screw and nut are provided



Part Number	Lathers Channel Size	Standard Packaging Quantity
LCSB12	3/4," 1," 1 1/2" or 2"	50

Notes: No Load Rating - Positioning Only

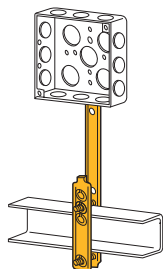

Miscellaneous



Miscellaneous

Hangers

- Permits pre-assembly of wire and plain rod (#8, 1/4" and 3/8")

Part Number	Fig. #	Description	Static Load (lbs)	Standard Packaging Quantity
708	1	For #8 wire or 1/4" plain rod	160	100
6A	2	For 3/8" plain rod	160	100

- Permits wire or chain drops from concrete or wood

Part Number	Fig. #	Description	Static Load (lbs)	Standard Packaging Quantity
AB	3	Angle bracket w/ 1/4" hole	160	100
AO	4	Offset bracket w/ 1/4" hole	160	100

- Rod hanger available for 1-1/4" and 3/8" threaded rod with or without thread impression

Part Number	Fig. #	Description	Static Load (lbs)	Standard Packaging Quantity
6T	5	For 1/4" or 3/8" threaded rod nuts required	160	100
4TI	5	For 1/4" threaded rod with thread impression	160	100
6TI	5	For 3/8" threaded rod with thread impression	160	100



Fig. #1



Fig. #2



Fig. #3



Fig. #4



Fig. #5

Pin Driven Angle Brackets

Features

- Longer leg angle bracket for tool clearance
- Designed to fit a variety of pin drivers
- Improved for easier installation with pin drivers
- Pre-galvanized steel
- Pre-assembly options available for rod, wire, strap and cable applications



Part Number	Description	Working Load (lbs)	Standard Packaging Quantity
AFAB3	Angle bracket with 1/4" slotted hole and 3/16" mounting hole.	160	100
AFAB4	1/4" mounting hole (includes 1/4- 20 x 3/8" round head screw)	350	50
AFAB6	3/8" mounting hole (includes 1/4- 20 x 3/8" round head screw)	350	50

Note: Load limits apply to CADDY® Fasteners only. Pin must be evaluated separately.



Strut Nuts

Features

- Available with a 1/4-20 staked stud 5/8" long
- Eliminates nuts and bolts
- Fits standard 1 5/8" strut
- Requires only a screwdriver to install, adjust or remove
- The combination washer-wing nut (Part No. 4WN) can be used to attach box or fixture (Not included with strut clip)
- Available with a 1/4-20 thread impression

1 5/8" (41 mm) wide

Part Number	Fig. #	Description
MFA4I	1	1/4-20 thread impression

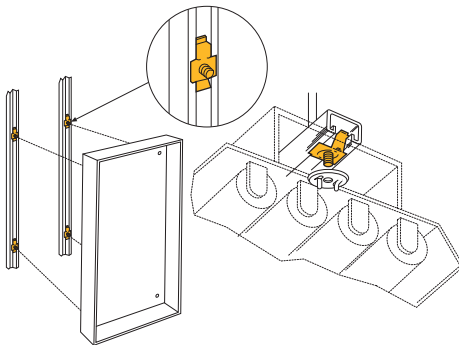

Fig. #1

Part Number	Fig. #	Description	Stud Length (in)
MFA625	2	1/4-20 x 5/8" stud	5/8



Fig. #2



Miscellaneous

Hammer on Flange Clip / Pipe Sleeve Positioner



Features

- Requires only a hammer to install
- Will accommodate Schedule #40, #80 and smaller wall thickness
- Provides secure positioning of pipe sleeve for concrete pouring of wall and floor forms

Notes: No Load Rating - Positioning Only

Part Number	Sleeve Diameter (in)	Wall Thickness	Standard Packaging Quantity
740	2 to 6	Sch. 40 pipe	100

Features

- Provides a "portable" 1/4" hole
- Fits most beams and bulb tees
- Installs with just a hammer



Part Number	Flange Thickness (in)	Standard Packaging Quantity
4H58	5/16 to 1/2	100

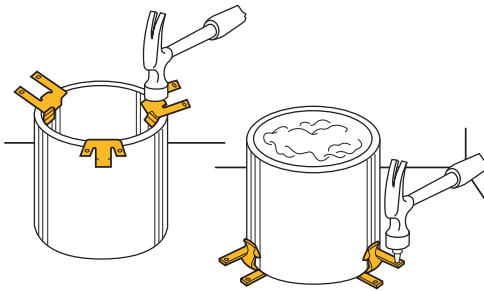

Miscellaneous

Signal Reference Grid Wire Clamp

Features

- Provides a quick method to mechanically support a signal reference grid wire below computer room floors.
- One fastener will support #2 wire, #8 stranded (.146) to #4 stranded (.280).
- Fits post sizes 3/4" to 1" round or square.
- Slots in fastener grip wire to provide positive contact with post.
- Clamps grid wire directly to post allowing a low resistance connection across bare metal contacts.
- Installs easily with a screwdriver or nut driver.



Part Number	Wire Size Gauge	Post Size (in)	Standard Packaging Quantity
RGC	#2 Wire, #8 Solid (.146) thru #4 Stranded (.280)	3/4 to 1 round or square	100

Metal Screws

- Minimizes drywall bulge.
- Self-drilling and tapping.

Patent Number: 5,740,994

Part Number	Fig. #	Description	Standard Packaging Quantity
SMS8	1	#8 x 1/2 low profile-self drilling and tapping screw	1,000



Fig. #1

Notes: Use to mount CADDY® Fasteners in all metal stud applications.

- For CADDY® CABLECAT Wide Base Cable Support.

Part Number	Fig. #	Description	Standard Packaging Quantity
S3575BP100	2	1/4- 20 x 3/8" round head screw	100
S3575DP100	2	1/4- 20 x 3/4" round head screw	100

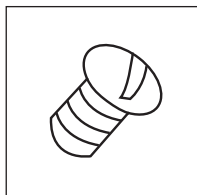

Fig. #2

Miscellaneous

HangerMate® Threaded Rod Anchoring System

Features

- Easy installation of 3/8-16 or 1/4 -20 threaded rod
- Vertical- or side-mount applications
- Installs and taps steel, wood and concrete with drill



Part Number	Rod Size (in)	Description	Standard Packaging Quantity
Concrete Applications – Vertical Mount (End-drilled Head)			
HMZG365	1/4-20	5/16 X 2-1/4" HangerMate Anchor	50
HMZG730	3/8-16	5/16 X 2-1/4" HangerMate Anchor	50
Steel Applications – Horizontal Mount (Cross-drilled Head)			
HMZH455	3/8-16	1/4-20 X 1" HangerMate Anchor, #2 point (.060-.125 steel thickness)	50
HMZH475	3/8-16	1/4-20 X 1" HangerMate Anchor, #3 point (.060-.250 steel thickness)	50
HMZH476*	3/8-16	1/4-20 X 1" HangerMate Anchor with nut, #3 point (.060-.250 steel thickness)	50
Steel Applications – Vertical Mount (End-drilled Head)			
HMZG160	1/4-20	1/4-20 HangerMate Anchor, #3 point	50
HMZG471*	3/8-16	1/4-20 HangerMate Anchor, #3 point with nut	50
HMZG550	3/8-16	5/16-24 X 1-1/8 HangerMate Anchor, #3 point	50
Wood Applications – Horizontal Mount (Cross-drilled Head)			
HMZH665	3/8-16	5/16 X 2-1/4" HangerMate Anchor	50
Wood Applications – Vertical Mount (End-drilled Head)			
HMZG315	1/4-20	5/16 X 2-1/4" HangerMate Anchor	50
HMZG660	3/8-16	5/16 X 2-1/4" HangerMate Anchor	50
Installation Tools			
HMZE215	-	Vert Recessed Drive Socket	1
HMZE220	-	Concrete Recessed Drive Sleeve	1
HMZE240	-	Drill Bit Adapter Kit	1
HMZE340	-	ANSI 1/4" Tanged Drill Bit for Hammer Drills	1
HMZE350	-	ANSI 1/4" SDS Drill Bit for Rotary Hammer Drills	1

*Nut required for light gauge steel applications (16 GA or 0.060")



HangerMate is a registered trademark of Textron Inc.

Reference

Convenient Sizing Information

RIGID STEEL CONDUIT (Heavy Wall Conduit)				
Nominal Conduit Size	Outside Diameter	Nominal Inside Diameter	Minimum Wt. Per 100 Ft. With Couplings Attached	Weight Of Conduit & Conductors Per 100 Ft.
3/8"	0.675 in.	0.493 in.	51.5 lbs.	65.1 lbs.
1/2"	0.840 in.	0.632 in.	79.0 lbs.	101.1 lbs.
3/4"	1.050 in.	0.836 in.	105.0 lbs.	145.8 lbs.
1"	1.315 in.	1.063 in.	153.0 lbs.	219.3 lbs.
1 1/4"	1.660 in.	1.394 in.	201.0 lbs.	318.3 lbs.
1 1/2"	1.900 in.	1.624 in.	249.0 lbs.	408.8 lbs.
2"	2.375 in.	2.083 in.	332.0 lbs.	593.8 lbs.
2 1/2"	2.875 in.	2.489 in.	527.0 lbs.	901.0 lbs.
3"	3.500 in.	3.090 in.	682.6 lbs.	1259.0 lbs.
3 1/2"	4.000 in.	3.570 in.	831.0 lbs.	1604.0 lbs.
4"	4.500 in.	4.050 in.	972.3 lbs.	1967.0 lbs.
INTERMEDIATE METAL CONDUIT				
1/2"	0.815 in.	0.745 in.	60.0 lbs.	82.1 lbs.
3/4"	1.029 in.	0.954 in.	82.0 lbs.	122.8 lbs.
1"	1.290 in.	1.205 in.	116.0 lbs.	182.3 lbs.
1 1/4"	1.638 in.	1.553 in.	150.0 lbs.	267.3 lbs.
1 1/2"	1.883 in.	1.793 in.	182.0 lbs.	341.8 lbs.
2"	2.360 in.	2.266 in.	242.0 lbs.	503.8 lbs.
2 1/2"	2.857 in.	2.727 in.	401.0 lbs.	775.0 lbs.
3"	3.476 in.	3.346 in.	493.0 lbs.	1069.0 lbs.
3 1/2"	3.971 in.	3.841 in.	573.0 lbs.	1346.0 lbs.
4"	4.466 in.	4.336 in.	638.0 lbs.	1632.0 lbs.
ELECTRICAL METALLIC TUBING (EMT) – THIN WALL CONDUIT				
3/8"	0.577 in.	0.493 in.	23.0 lbs.	36.6 lbs.
1/2"	0.706 in.	0.622 in.	28.5 lbs.	50.6 lbs.
3/4"	0.922 in.	0.824 in.	43.5 lbs.	84.3 lbs.
1"	1.163 in.	1.049 in.	64.0 lbs.	130.3 lbs.
1 1/4"	1.510 in.	1.380 in.	95.0 lbs.	212.3 lbs.
1 1/2"	1.740 in.	1.610 in.	110.0 lbs.	269.8 lbs.
2"	2.197 in.	2.067 in.	140.0 lbs.	401.8 lbs.
2 1/2"	2.875 in.	2.731 in.	205.0 lbs.	579.0 lbs.
3"	3.500 in.	3.356 in.	250.0 lbs.	826.3 lbs.
3 1/2"	4.000 in.	3.834 in.	325.0 lbs.	1098.0 lbs.
4"	4.500 in.	4.334 in.	370.0 lbs.	1364.0 lbs.

Dimensions taken from ANSI™ C80.3-1977.

Conduit plus weight of heaviest conductor combination as specified by the National Electrical Code.

Reference

RIGID ALUMINUM CONDUIT

Nominal Conduit Size	Outside Diameter	Nominal Inside Diameter	Minimum Wt. Per 100 Ft. With Couplings Attached	Weight Of Conduit & Conductors Per 100 Ft.
1/2"	0.840 in.	0.632 in.	27.4 lbs.	49.5 lbs.
3/4"	1.050 in.	0.836 in.	36.4 lbs.	77.2 lbs.
1"	1.315 in.	1.063 in.	53.0 lbs.	119.3 lbs.
1 1/4"	1.660 in.	1.394 in.	69.6 lbs.	186.9 lbs.
1 1/2"	1.900 in.	1.624 in.	82.2 lbs.	242.0 lbs.
2"	2.375 in.	2.083 in.	115.7 lbs.	377.5 lbs.
2 1/2"	2.875 in.	2.489 in.	182.5 lbs.	556.5 lbs.
3"	3.500 in.	3.090 in.	238.9 lbs.	815.2 lbs.
3 1/2"	4.000 in.	3.570 in.	287.7 lbs.	1061.0 lbs.
4"	4.500 in.	4.050 in.	340.0 lbs.	1334.0 lbs.
5"	5.563 in.	5.073 in.	465.4 lbs.	2028.0 lbs.
6"	6.625 in.	6.093 in.	612.5 lbs.	2870.0 lbs.

Dimensions taken from ANSI C80.5-1977.

Conduit plus weight of heaviest conductor combination as specified by the National Electrical Code.

SCHEDULE 40 PVC PLASTIC PIPE

Nominal Pipe Size	Outside Diameter	Wall Thickness	Weight Of Pipe	Weight Of Water
1/8"	.405 in.	.068 in.	.04 lbs./ft.	.02 lbs./ft.
1/4"	.540 in.	.088 in.	.07 lbs./ft.	.04 lbs./ft.
3/8"	.675 in.	.091 in.	.10 lbs./ft.	.08 lbs./ft.
1/2"	.840 in.	.109 in.	.15 lbs./ft.	.1 lbs./ft.
3/4"	1.050 in.	.113 in.	.2 lbs./ft.	.2 lbs./ft.
1"	1.315 in.	.133 in.	.3 lbs./ft.	.4 lbs./ft.
1 1/4"	1.660 in.	.140 in.	.4 lbs./ft.	.6 lbs./ft.
1 1/2"	1.900 in.	.145 in.	.5 lbs./ft.	.9 lbs./ft.
2"	2.375 in.	.154 in.	.6 lbs./ft.	1.4 lbs./ft.
2 1/2"	2.875 in.	.203 in.	1.0 lbs./ft.	2.1 lbs./ft.
3"	3.500 in.	.216 in.	1.3 lbs./ft.	3.2 lbs./ft.
3 1/2"	4.000 in.	.226 in.	1.6 lbs./ft.	4.3 lbs./ft.
4"	4.500 in.	.237 in.	1.9 lbs./ft.	5.5 lbs./ft.



Reference

ALL THREADED ROD (ATR)

Nominal Size and Thread	Root Area		Design Load (SF = 5)	
1/4" - 20"	0.027 in.2	0.174 cm2	240 lbs.	1.07 kN
5/16" - 18"	0.045 in.2	0.290 cm2	400 lbs.	1.78 kN
3/8" - 16"	0.068 in.2	0.438 cm2	610 lbs.	2.71 kN

Dimensions taken from ANSI™ B1.1-1982 Unified Inch Screw Threads.

All threads are UNCR series.

Tabulated loads are based on an allowable tensile stress of 12000 psi (82.7 MPa) reduced by 25% resulting in 9000 psi (62 MPa). From ANSI®/MSS SP-58, Table 3.

MC CABLE

AWG Size	INSULATED GROUND	BARE GROUND
	Nominal Outer Diameter in Inches	Nominal Outer Diameter in Inches
14-2 Solid	.450	.430
14-3 Solid	.480	.435
14-4 Solid	.510	.485
12-2 Solid	.495	.465
12-3 Solid	.530	.500
12-4 Solid	.565	.560
10-2 Solid	.560	.520
10-3 Solid	.600	.550
10-4 Solid	.645	.615
8-2 Strd.	.710	.675
8-3 Strd.	.770	.710
8-4 Strd.	.835	.770
6-2 Strd.	.795	.755
6-3 Strd.	.865	.800
6-4 Strd.	.945	.865
4-2 Strd.	.945	.895
4-3 Strd.	1.035	.945
4-4 Strd.	1.135	1.035
2-2 Strd.	1.075	1.015
2-3 Strd.	1.180	1.075
2-4 Strd.	1.295	1.180

ANSI is a trademark of American National Standards Institute, Inc.

AC CABLE										
MINIMUM EXTERNAL DIAMETER OF ARMOR IN INCHES										
Type Of Armored Cable	Type Of Circuit Conductor	AWG Size Of Circuit Conductors	Cable with Two Circuit Conductors and No Grounding Conductor		Cable with Three Circuit Conductors and No Grounding Conductor and Cable with Two Circuit Conductors and a Grounding Conductor		Cable with Four Circuit Conductors and No Grounding Conductor and Cable with Three Circuit Conductors and a Grounding Conductor		Cable with Four Circuit Conductors and a Grounding Conductor	
			Solid	Stranded	Solid	Stranded	Solid	Stranded	Solid	Stranded
ACTMM		14	0.433		0.453		0.486		0.522	
		12	0.467		0.489		0.520		0.545	
	10	0.476		0.500		0.541		0.587		
	THHN	8	0.570	0.604	0.601	0.637	0.654	0.695	0.714	0.759
		6		0.700		0.739		0.807		0.882
	4		0.836		0.885		0.970		1.066	
2		0.956		1.014		1.115		1.228		



The CADDY® Fastener Story

QUALITY CONTROL

CADDY Fasteners, manufactured by ERICO, are produced from spring steel, galvanized steel, plastic, as well as other materials. We are known in the industry as a leader in the design and production of spring steel fasteners. The following is the story of how we manufacture these quality spring steel fasteners.

MANUFACTURING

The steel for CADDY Fasteners is procured in mill lots to AISI and ERICO Standards; other materials are equally controlled.

LOAD RATING

CADDY Fasteners are designed with two load limits:

- 1) **Static load limit** is a rated stationary load limit for a fastener. ERICO Standards require that test samples withstand a load equal to three times this catalog rating.
- 2) The **ultimate static load limit** is the rated stationary load limit which, if exceeded, may cause failure of the fastener. ERICO Standards require that test samples withstand this catalog rating. Some CADDY Fasteners also are designed with an undefined rating and are to be used for positioning only with no loading on them.
- 3) Applications and load ratings may change without notice. Refer to instruction sheet in box or contact ERICO for current load and application information.

Static load limit and ultimate static load limit values specify maximum allowable installed loads for user applications. These values are for loads applied VERTICALLY to the normal fastener installation except as may be diagrammed otherwise. Where the load rating of the CADDY Fastener exceeds that of the structural member, the lowest rated item must set the load limit.

NOTE: CADDY Fasteners are intended for support of electrical components at stationary loads. Not to be used for dynamic loads such as fluid and gas distribution components, etc.

IMPORTANT

CADDY Fasteners used with wire, rod, or threaded rod are designed for use with coarse round wire, hot rolled carbon steel bar, cold rolled carbon steel bar and threaded rod all meeting AISI specifications and tolerances.

QUALITY ASSURANCE

Incoming steel is sampled and inspected for conformance to AISI specifications and ERICO Standards. Test fixtures and procedures for development and quality control are designed to simulate normal field applications. Fasteners are tested, on a sample basis, to ERICO Standards by certified inspectors. Testing of specific quantities of fasteners to destruction in special statistical audits ensures a continuous high level of quality.

The CADDY® Fastener Story

HEAT TREATING

CADDY® Spring Steel Fasteners are heat treated in modern shaker hearth furnaces. Precision controls maintain heat treat operations within the established limits developed by ERICO® for CADDY Fasteners. ERICO Standards incorporate consideration of fastener material and application.

CADDY Fasteners are conveyed directly from the high temperature furnace to the quench tank, through a cleaning cycle and into the tempering furnace. The complete heat treat cycle is automatically controlled.

PRODUCTION PRESSES

CADDY Fasteners are produced with modern presses and precision tooling. Presses and tools are designed for close tolerance stamping.

RESEARCH AND DEVELOPMENT

ERICO Research and Development department is constantly working on new fasteners and, at the same time, improving the present line. Starting with six basic fasteners, the line now has several hundred basic types. The majority of the CADDY Fastener line is the result of ERICO development of fasteners to provide a solution for a customer's problem.

NOTE: Special applications not specified MUST be submitted to ERICO for engineering approval and load rating.

All cULus Listed CADDY fasteners meet the requirements of one of the following UL standards: UL1565, UL2239 or UL514B.

Materials/Coatings

CADDY Fasteners, manufactured by ERICO, are produced from a number of different materials and coatings to accommodate different applications and environments. Among the materials included are low carbon steel, spring steel, malleable iron, aluminum and stainless steel. Protective coatings are available in five basic zinc coatings: zinc phosphate, zinc electroplate, pre-galvanized zinc, mechanical galvanized zinc, hot dip galvanized and CADDY® ARMOUR.

CADDY® ERISTRUT comes in the following finishes: aluminum, chromate (California) gold, copper, electro galvanized zinc plated, green, hot dip galvanized, pre-galvanized, plain steel, plastic, and stainless steel.

MATERIALS

Spring Steel

Spring steel provides light weight fasteners with high gripping power. These fasteners are designed to support a wide range of products from or to a variety of support members. These fasteners are fabricated from high carbon, annealed, spring steel.

NOTE: Spring Steel CADDY Fasteners are designed for indoor and non-corrosive environments. Not to be used in certain areas such as over indoor pools, etc.



The CADDY® Fastener Story

MATERIALS (continued)

Malleable Iron

ANSI/ASTM A 47-77, Grade 32510, annealed.

Aluminum (AL)

Aluminum provides a high strength to weight ratio that improves ease of use for reduced installation costs, is nonmagnetic and provides good corrosion resistance in a variety of environments. The aluminum selected is designed to meet the fastener manufacturing process and the intended application to meet the loads as specified.

Aluminum products are recommended for indoor and outdoor applications. They may also be used in select corrosive environments.

Stainless Steel (SS)

AISI Type 302 or Type 304 (as noted). Type 316 is available on special request for fasteners as noted.

The above stainless steels belong to the austenitic group and provide many desirable properties including high ambient temperature resistance, corrosion resistance, stable structural properties and are nonmagnetic.

Stainless steel products are recommended for indoor and outdoor applications. They are also recommended for corrosive environments; dependent on the grade of stainless steel.

COATINGS

Zinc Electroplate, Electrogalvanized (EG)

ANSI/ASTM B633

This corrosion protective coating is applied after the fabrication of steel or malleable iron parts and uses an electrolytic plating process that deposits zinc up to 0.5 mils. A second passivation coating of chromate is then applied for additional protection.

Zinc electroplate products are recommended for indoor and mildly corrosive applications.

Zinc Phosphate (ZP)

This is the coating system generally used on CADDY spring steel fasteners. It is a two coating system, where the first coating of crystalline zinc phosphate, of over 1000 milligrams per square foot, is designed to increase the adhesion of the second coating. The second coating consists of a synthetic, organic corrosion inhibitor with a particular affinity for zinc compounds. ERICO rates this fastener finish at 30 hours. Salt spray testing is in accordance with ASTM B117-61, Federal Test Number QQM-151.

NOTE: Black Spring Steel CADDY Fasteners are designed for indoor and non-corrosive environments. Not to be used in certain areas such as over indoor pools, etc. Other finishes are used and may be suitable for indoor and outdoor applications where EMT conduit is used.

The CADDY® Fastener Story

Pre-galvanized Zinc (PG)

ANSI/ASTM A 525 and 526

Pregalvanized zinc is produced by continuously rolling steel coils or sheets through molten zinc at the mills. The coils or sheets are slit to size and fabricated by forming, shearing or punching to produce the finished product. During fabrication cut edges are not generally zinc coated; however, the zinc near the uncoated metal becomes a sacrificial anode to protect the bare areas.

Pregalvanized zinc products are generally recommended for indoor use on mildly corrosive environments.

Mechanical Galvanized Zinc (EPZ)

ASTM B 695 -90

Mechanical galvanized zinc is a method of depositing zinc using mechanical forces. The resulting layer of zinc is approximately 1 mil (25 microns), is passivated with clear chromate and then sealed with a transparent sealer.

Mechanical galvanized zinc products are recommended for indoor, outdoor and mildly corrosive environments.

Hot Dip Galvanized Zinc (HDG)

ASTM A123

After a product has finished its fabrication process, it is dipped into a bath of molten zinc. The zinc completely coats all edges and surfaces. Zinc thickness is controlled by the time the part is immersed in the molten zinc bath.

Hot dip galvanized zinc products are recommended for indoor, outdoor and mildly corrosive environments.

IMPORTANT: For more detailed information on a specific product, application or application environment, please contact ERICO Engineering.

CADDY® ARMOUR

The CADDY® ARMOUR coating system features bi-metallic corrosion protection with an inorganic basecoat for sacrificial protection and an organic topcoat for barrier protection. The ERICO standard for CADDY ARMOUR includes at least 1,000 hours resistance against red rust when tested per the ASTM B117, DIN 50021, or ISO/R 1456 salt spray tests.

The CADDY ARMOUR manufacturing line is optimized to control heat energy, thereby minimizing fossil fuel use. Our energy-efficient coating process minimizes waste by reusing coatings in the process, rather than by burning off excess coatings, into the air. The entire coating process has been designed with a waste minimization approach, which allows the reuse of water and process streams.

CADDY® ARMOUR is RoHS compliant.

*Note : Spring steel fasteners are for indoor use in non-corrosive environments. Mild steel fasteners can be used outdoors in humid or mildly corrosive environments. Not to be used in certain areas such as over indoor pools, etc.



Index

0502510EG	132	16M912SM	59	24M912	58
0503710EG	132	16MATA	218	24M912SM	59
0505010EG	132	16MATS	218	24MCPNAM	74
★ 122	105	★ 16MB18	72	24MTDH	74
★ 1224TI	105	★ 16MB1824	72	★ 2B15LS	232
★ 1226A	105	★ 16MB1858	72	★ 2BR12	202
1226T	105	★ 16MB186	72	★ 2BR20	202
1226TI	105	★ 16MB18A	72	★ 2BR32	202
★ 122708	105	16MB18CPNAM	74	★ 2BR8	202
★ 123	105	16MB18TDH	74	★ 2BRT12	202
12312P	105	16MCPNAM	74	★ 2BRT20	202
★ 12316M	105	★ 16MF	157	★ 2BRT32	202
12316P	105	16MTDH	74	★ 2BRT8	202
★ 12320M	105	16P	54	2EBN	138
★ 1236M	105	16P16P	64	★ 2FMP28	200
★ 123812M	105	16P24	57	▲ 2G9	225
1238P	105	16P24SM	57	▲ 2G9S10	225
12D15L	227	16P4I	54	★ 2H4	97
12P	54	16P58	57	★ 3000037EG	110
12P12P	64	16P58SM	57	★ 3000050EG	110
12P16P	64	16P912	57	★ 3000062EG	110
12P24	57	16P912SM	57	★ 3000075EG	110
12P24SM	57	16PATA	218	★ 304B2	154
12P4I	54	16PATS	218	★ 3100037EG	110
12P58	57	16PF	157	★ 3100050EG	110
12P58SM	57	2000037EG	114	★ 3150037EG	111
12P912	57	★ 200RS375	127	★ 32M	54
12P912SM	57	200RS500	127	★ 32M24	58
12PATA	218	20D15L	227	★ 32M24SM	59
12PATS	218	★ 20M	54	★ 32M4I	54
12PF	157	★ 20M24	58	★ 32M58	58
★ 1616M	64	★ 20M24SM	59	★ 32M58SM	59
★ 1620M	64	★ 20M4I	54	★ 32M912	58
★ 1624M	64	20M58	58	★ 32M912SM	59
★ 1632M	64	20M58SM	59	★ 350	158
166M	64	20M912	58	35012P	158
★ 16812M	64	20M912SM	59	35016M	158
16D15L	227	20MCPNAM	74	35016P	158
16M	54	20MTDH	74	350812M	158
16M24	58	★ 24M	54	3508P	158
16M24SM	59	★ 24M24	58	★ 449	77
16M4I	54	★ 24M24SM	59	459	171
16M58	58	★ 24M4I	54	★ 4ACS	231
16M58SM	59	24M58	58	★ 4B15L	232
16M912	58	24M58SM	59	★ 4B15LS	232



Index

★ 4B2LS	232	★ 51212	220	★ 6MB18	72
★ 4BRT20	202	51220	220	★ 6MB1824	72
★ 4BRT20WS	202	51230	220	★ 6MB1858	72
★ 4BRT32	202	512A	220	★ 6MB186	72
★ 4BRT32WS	202	512ATC	220	★ 6MB18A	72
★ 4BRT64	202	★ 512HD	221	6MB18CPNAM	74
4EBN	138	512HDEEP	221	6MB18TDH	74
▲ 4G16	226	512HDEEPTC	221	6MCPNAM	74
4G1615	226	★ 512HDFM35	222	★ 6MF	157
▲ 4G162	226	★ 512HDFM70	222	6MTDH	74
▲ 4G163	226	★ 512HDTC	221	6NJ2438	108
▲ 4G16H	226	★ 512HDXT	221	★ 6T	236
4G24	226	512TC	220	★ 6TA24	101, 136
▲ 4G8	225	▲ 515	217	★ 6TA58	101, 136
▲ 4G8S7	225	▲ 515A	217	★ 6TA912	101, 136
▲ 4G8S7WH	225	515AWHA	217	6TAFAB3	135
▲ 4G8WH	225	517A	224	★ 6TB	134
▲ 4G9	226	517B	224	★ 6TI	236
★ 4H24	97	517C	224	★ 6TI24	82, 101, 136
★ 4H58	97, 238	517FCA	224	★ 6TI58	82, 101, 136
★ 4H912	97	517FCB	224	★ 6TI912	82, 101, 136
4J2438	108	517FCC	224	6TIAFAB3	135
4J2438S	108	520	225	★ 6TIB	134
4LCB	233	528	230	★ 6TIO	134
4NJ2438	108	52812P	230	★ 6TO	134
4TGS	226	52816P	230	★ 6W	137
★ 4TI	236	5288P	230	★ 6Z34	63
★ 4TI24	101, 136	★ 6A	236	6Z3412P	63
★ 4TI58	82, 101, 136	★ 6A24	101, 136	★ 6Z3416M	63
★ 4TI912	101, 136	★ 6A58	101, 136	6Z3416P	63
4TIAFAB3	135	★ 6A912	101, 136	★ 6Z34812M	63
★ 4TIB	134	★ 6AB	134	6Z348P	63
★ 4TIO	134	6AFAB3	135	★ 6Z45	63
★ 4TW	137	★ 6AO	134	★ 708	236
4WN	82	6EBN	138	★ 70824	101, 136
★ 4Z34	63	★ 6M	54	★ 70858	101, 136
4Z3412P	63	★ 6M24	58	★ 708912	101, 136
★ 4Z3416M	63	★ 6M24SM	59	★ 708AB	134
4Z3416P	63	★ 6M4I	54	708AFAB3	135
★ 4Z34812M	63	6M58	58	★ 708AO	134
4Z348P	63	6M58SM	59	740	238
★ 4Z45	63	6M912	58	★ 766	156
★ 510HD	221	6M912SM	59	★ 766A	156
510HDTC	221	6MATA	218	■ 766PM	156
512	220	6MATS	218	■ 766PMD	156



Index

770	228	A14H1000GN	118	BC16P	98
771	228	A14H1000PG	118	BC16PSM	98
★ 781	170	A14H2000GN	118	BC17A000EG	128
★ 812M	54	A14H2000PG	118	BC17D000EG	128
★ 812M24	58	★ AB	236	BC17PL00EG	128
★ 812M245M	59	★ AF14	104	BC180037EG	128
★ 812M4I	54	★ AF144TI	104	BC180050EG	128
812M58	58	★ AF146A	104	★ BC200	100
812M58SM	59	★ AF146T	104	BC200000EG	128
812M912	58	★ AF146TI	104	★ BC200CD0B	100
812M912SM	59	★ AF14708	104	★ BC200CD1B	100
812MATA	218	★ AFAB3	135, 236	★ BC200CD2.5B	100
812MATS	218	★ AFAB4	236	★ BC200CD2B	100
★ 812MB18	72	★ AFAB6	236	★ BC200CD3B	100
★ 812MB1824	72	★ AO	236	★ BC200CD4B	100
★ 812MB1858	72	AOL12P	94	★ BC200CD5B	100
★ 812MB186	72	AOL16P	94	★ BC20M	98
★ 812MB18A	72	AOL8P	94	★ BC20MSM	98
812MB18CPNAM	74	AR812	171	BC210000EG	128
★ 812MB185	72	ATA4I	218	BC23A000EG	130
812MB18TDH	74	ATS4I	218	★ BC24M	98
812MCPNAM	74	B18SBT18	72	★ BC24MSM	98
812MF	157	B18SBT184Z	72	BC260025EG	110
812MTDH	74	B18SBT18CPNAM	74	★ BC32M	98
8D15L	227	B18SBT18TDH	74	★ BC32MSM	98
8P	54	★ BC	98	★ BC400	100
8P12P	64	BC090900EG	113	★ BC812M	98
8P16P	64	BC091200EG	113	★ BC812MSM	98
8P24	57	BC091500EG	113	BC8P	98
8P245M	57	BC100000EG	112	BC8PSM	98
8P4I	54	BC101500EG	112	★ BCISN375	98
8P58	57	BC110000EG	113	C12H1000GN	118
8P58SM	57	BC120000EG	113	C12H1000PG	118
8P8P	64	BC12P	98	C12H2000GN	118
8P912	57	BC12PSM	98	C12H2000PG	118
8P912SM	57	BC130025EG	109	C14H1000GN	118
8PATA	218	BC130037EG	109	C14H1000PG	118
8PATS	218	BC130050EG	109	C14H2000GN	118
8PF	157	BC130062EG	109	C14H2000PG	118
A12AH200GN	118	BC140037EG	109	C24165M	107
A12AH200PG	118	BC140050EG	109	C248125M	107
A12H1000GN	118	BC140062EG	109	C4TI24	107
A12H1000PG	118	BC16A000EG	128	C4TI58	107
A12H2000GN	118	★ BC16M	98	C4TI912	107
A12H2000PG	118	★ BC16MSM	98	C58165M	107



Index

C58812SM	107	★ CAT21BC	188	CAT600RKIT	195
C6TI24	107	★ CAT21BC200	188	★ CAT600WM	195
C6TI58	107	★ CAT21BC200B	188	★ CAT64	184
C6TI912	107	★ CAT21BCB	188	★ CAT6424	192
C91216SM	107	★ CAT21CD1B	188	★ CAT64245M	192
C912812SM	107	CAT21ESC	188	★ CAT6458	192
★ CAT100CM	198	★ CAT21VF14	188	★ CAT6458SM	192
★ CAT12	184	★ CAT300CM	198	★ CAT64912	192
★ CAT1224	186	★ CAT300CMLN	198	★ CAT64912SM	192
★ CAT1224SM	186	★ CAT32	184	★ CAT64AF14	192
★ CAT124Z34	186	★ CAT3224	190	★ CAT64AFAB3	192
★ CAT1258	186	★ CAT32245M	190	★ CAT64AFAB4	192
★ CAT1258SM	186	★ CAT324Z34	190	★ CAT64AFAB6	192
★ CAT126Z34	186	★ CAT3258	190	★ CAT64BC	192
★ CAT12912	186	★ CAT3258SM	190	★ CAT64BC200	192
★ CAT12912SM	186	★ CAT326Z34	190	★ CAT64BC200B	192
★ CAT12AB	186	★ CAT32912	190	★ CAT64BCB	192
★ CAT12AF14	186	★ CAT32912SM	190	★ CAT64CD1B	192
CAT12AFAB3	186	★ CAT32AB	190	★ CAT64HP	182
★ CAT12BC	186	★ CAT32AF14	190	CAT64PLR	194
★ CAT12BC200	186	★ CAT32AFAB3	190	★ CAT64VF14	192
CAT12BC200B	186	★ CAT32AFAB4	190	★ CATCR50	204
CAT12BCB	186	★ CAT32AFAB6	190	★ CATHBA	184
★ CAT12CD1B	186	★ CAT32BC	190	CATHBA3	184
CAT12ESC	186	★ CAT32BC200	190	CATHBA6	184
★ CAT12TS	186	★ CAT32BC200B	190	CATHBA8	184
★ CAT12VF14	186	★ CAT32BCB	190	★ CATHP24	182
★ CAT16HP	182	★ CAT32CD1B	190	★ CATHP245M	182
★ CAT16HPTS	182	CAT32ESC	190	★ CATHP4Z34	182
★ CAT200CM	198	★ CAT32HP	182	★ CATHP58	182
★ CAT200CMLN	198	CAT32PLR	194	★ CATHP58SM	182
★ CAT21	184	★ CAT32VF14	190	★ CATHP6Z34	182
★ CAT2124	188	★ CAT425	196	★ CATHP912	182
★ CAT21245M	188	★ CAT425245M	196	★ CATHP912SM	182
★ CAT214Z34	188	★ CAT42558SM	196	★ CATHPA4	182
★ CAT2158	188	★ CAT425912SM	196	★ CATHPA6	182
★ CAT2158SM	188	★ CAT425A6	196	★ CATHPAF14	182
★ CAT216Z34	188	★ CAT425AF14	196	★ CATHPAN	182
★ CAT21912	188	★ CAT425BC	196	★ CATHPBC	182
★ CAT21912SM	188	★ CAT425BC200	196	★ CATHPBC200	182
★ CAT21AB	188	★ CAT425VF14	196	★ CATHPBC200B	182
★ CAT21AF14	188	★ CAT425WM	196	★ CATHPBCB	182
★ CAT21AFAB3	188	★ CAT425WMCD1B	196	★ CATHPCD0B	182
★ CAT21AFAB4	188	★ CAT48HP	182	★ CATHPCD1B	182
★ CAT21AFAB6	188	★ CAT600R	195	★ CATHPCD2.5B	182



Index

★ CATHPCD2B	182	★ CJ6S	169	ET0050HD	115
★ CATHPESC	182	CM2416M	107	ET0100HD	115
CATHPLR	182	CM24812M	107	ET0125HD	115
★ CATHPS4	182	CM24S	107	ET0150HD	115
★ CATHPTM	182	CM5816M	107	ET0200HD	115
★ CATHPVF14	182	CM58812M	107	ET0250HD	115
CATKITA	184	CM58S	107	ET0300HD	115
CATKITB	184	CM91216M	107	F140000EG	132
CATKITC	184	CM912812M	107	F150000EG	132
CATMTH	203	CM912S	107	FB12P	171
CATMTLS	203	CNB12P	94	★ FB6M	171
CATMTP	203	★ CNB812M	94	★ FB812M	171
CATRL200CM	198	CNB8P	94	FB8P	171
CATRL300CM	198	CONB122000PG	118	FBS12	164
CATRT200CM	198	CPNAM	74	FBS16	164
CATRT300CM	198	CRLA37EG	139	FBS18	164
CATTBCM	198	★ CRLB37EG	96	★ FMBS18	165
★ CATTS	184	CRLS37EG	119	FMSBC1	223
CATWMCM	198	★ CS16	152	★ FXC20	170
CCS812	164	★ CS812	152	★ H23	151
★ CD0B	56	★ CS812D	152	H23TC	151
CD0BCPNAM	74	DBM2	155	★ H4	151
CD0BTDH	74	★ DH2	141	H46TC	151
★ CD1B	56	★ DH4TI	141	★ H6	151
CD1BCPNAM	74	★ DH6A	141	HMZE215	240
CD1BTDH	74	★ DH6T	141	HMZE220	240
★ CD2.5B	56	★ DH6TI	141	HMZE240	240
CD2.5BCPNAM	74	★ DH708	141	HMZE340	240
CD2.5BTDH	74	DSB	176	HMZE350	240
★ CD2B	56	★ DS12A	176	HMZG160	240
CD2BCPNAM	74	EC311	229	HMZG315	240
CD2BTDH	74	EC3114Z34	229	HMZG365	240
★ CD3B	56	EC3116Z34	229	HMZG471	240
★ CD4B	56	EC311P	229	HMZG550	240
★ CD5B	56	ESC12P	131	HMZG660	240
CD6B	56	★ ESC4	131	HMZG730	240
CD7B	56	★ ESC4TI	131	HMZH455	240
CD8B	56	★ ESC6M	131	HMZH475	240
CD9B	56	★ ESC6TI	131	HMZH476	240
★ CER4	168	★ ESC812M	131	HMZH665	240
CG4	167, 201	ESC8P	131	HRL15A	232
CHB	220	ESG1	172, 212	★ HS3	151
CHBTC	220	ESG1M	172, 212	▲ IDS	219
★ CJ6	169	ESGFP	172	IDS15	219
★ CJ6IN	169	ESGP	172, 212	▲ IDS2	219



Index

▲ IDS9	219	★ MAC2FB	68	★ MP1P	179, 211
IDS95	219	★ MAC2T	68	★ MP1S	166, 208
IDS95T	219	MAC2VF14	68	★ MP1SCB	207
IDS9T	219	★ MCS100	78	★ MP1WWM	178, 210
IDST	219	★ MCS10024	78	★ MP2S	166, 208
INC8T5	130	★ MCS1004Z	78	★ MP2SCB	207
ISN375	138	★ MCS10058	78	★ MP34P	179, 211
ISSP375	140	★ MCS1006Z	78	★ MPAL2	179, 211
ISSPK	140	★ MCS100912	78	★ MPCB1220	207
★ J1A35	156	★ MCS100AF14	78	★ MPLS	180, 209
★ K12	60	★ MCS100BC	78	★ MPLS2	180, 209
★ K16	60	★ MCS100BC200	78	★ MPVTI	177
★ K20	60	★ MCS100VF14	78	★ MSF	155
★ K8	60	★ MCS101	78	MSP20	173, 212
KBT	213	★ MCS10124	78	MSR24	143
★ KX	60	★ MCS1014Z	78	MSR58	143
LCSB12	234	★ MCS10158	78	MSR912	143
LFC	228	★ MCS1016Z	78	MSRBC200	143
LFC90	228	★ MCS101912	78	MSS24	143
L11	206	★ MCS101AF14	78	MSS58	143
L11B	206	★ MCS101BC	78	MSS912	143
L11W	206	★ MCS101BC200	78	MSSAFAB3	143
L12	206	★ MCS101VF14	78	MSSBC200	143
L12B	206	★ MCS50	78	NUT0025EG	120
L12W	206	★ MCS5024	78	NUT0031EG	120
LTGH	233	★ MCS504Z	78	NUT0037EG	120
★ M24	102	★ MCS5058	78	NUT0050EG	120
★ M24S	102	★ MCS506Z	78	NUT0062EG	120
★ M58	102	★ MCS50912	78	NUT0075EG	120
★ M58S	102	★ MCS50AF14	78	P110000EG	88
★ M912	102	★ MCS50BC	78	P110000HD	88
★ M912S	102	★ MCS50BC200	78	PAR0037HD	115
★ MAC2	68	★ MCS50VF14	78	PAR0050HD	115
★ MAC2123	68	★ MEB1	153	PAR0100HD	115
★ MAC224	68	★ MF250	157	PAR0125HD	115
★ MAC224SM	68	★ MF375	157	PAR0150HD	115
★ MAC24Z34	68	★ MF500	157	PAR0200HD	115
★ MAC258	68	★ MF625	157	PAR0250HD	115
★ MAC258SM	68	★ MF750	157	PAR0300HD	115
★ MAC26Z34	68	★ MFA4I	120, 237	PAR0350HD	115
★ MAC2912	68	★ MFA625	120, 237	PAR0400HD	115
★ MAC2912SM	68	★ MFI	157	★ PCS1	62
MAC2AO	68	★ MFO	157	PCS2	62
MAC2ATA	68, 218	★ MFS	157	★ PH4	106
★ MAC2BC	68	★ MP1	180, 209	★ PH6	106



Index

★ PHSW4	106	RMX6Z34	70	SBT1824	80
★ PHSW6	106	★ RMX912	70	SBT1824SM	80
PPRPS25H4	90	★ RMXAB	70	SBT184Z34	80
PPRPS25H6	90	★ RMXAF14	70	SBT1858	80
PT16	227	★ RMXAO	70	SBT1858SM	80
PT16FP	227	★ RMXATS	70	SBT186Z34	80
PT16SPCR	227	★ RMXBC	70	SBT18912	80
RA0037HD	115	★ RMXDH2	70	SBT18912SM	80
RA0050HD	115	★ RMXVF14	70	SBT18BC	80
RA0100HD	115	RPS150T1	91	SBT18BC200	80
RA0125HD	115	RPS150T2	91	SBT18TDH	74
RA0150HD	115	RPS300T1	91	SC2A	76
RA0200HD	115	RPS300T2	91	SC2B	76
RA0250HD	115	RPS360400	83	SC2C	76
RA0300HD	115	RPS360401	83	SC2D	76
RA0350HD	115	RPS360402	84	SC2E	76
RA0400HD	115	RPS360403	83	SC2F	76
★ RBS16	160	RPS360404	83	SC2G	76
★ RBS24	160	RPS360405	84	SC4A	76
★ RGC	239	RPS360406	85	SC4B	76
★ RIGD0050XX	67	RPS360407	86	SC4C	76
★ RIGD0050XX	124	RPS360408	85	SC4D	76
★ RIGD0075XX	67	RPS360409	86	SC4E	76
★ RIGD0075XX	124	RPS360410	88	SC4F	76
★ RIGD0100XX	67	RPS360411	88	SC4G	76
★ RIGD0100XX	124	RPS360412	88	SC8A	76
★ RIGD0125XX	67	RPS360413	88	SC8B	76
★ RIGD0125XX	124	RPS360420	93	SC8C	76
★ RIGD0150XX	67	RPS360421	93	SC8D	76
★ RIGD0150XX	124	RPS360422	93	SC8E	76
★ RIGD0200XX	67	RPS360423	93	SC8F	76
★ RIGD0200XX	124	RPS50AHSV	90	SC8G	76
★ RIGD0250XX	67	RPS50H4EG	90	★ SCH12	65, 125
★ RIGD0250XX	124	RPS50H6EG	90	★ SCH12B	65, 125
★ RIGD0300XX	67	RPS600T2	92	SCH16	65, 125
★ RIGD0300XX	124	RPSCSEG	88	SCH16B	65, 125
★ RIGD0350XX	67	RPSE1H24	87	★ SCH20	65, 125
★ RIGD0350XX	124	RPSE1H57	87	★ SCH20B	65, 125
★ RIGD0400XX	67	RPSE2H46	87	★ SCH24B	65, 125
★ RIGD0400XX	124	RPSE4H46	87	★ SCH32B	65, 125
★ RLC	177	S102438BP50	220	★ SCH40B	65, 125
★ RMX	70	S3575BP100	185, 239	★ SCH48B	65, 125
★ RMX24	70	S3575BP50	220	★ SCH56B	65, 125
★ RMX4Z34	70	S3575DP100	185, 239	★ SCH64B	65, 125
★ RMX58	70	SBT18	80	★ SCH6B	65, 125



Index

★ SCH72B	65, 125	★ SLD15L1TTP	146	★ SLD2YH500	144
★ SCH8	65, 125	★ SLD15L2	146	★ SLD2YH500L2	144
★ SCH8B	65, 125	★ SLD15L2T	146	★ SLD2YH500L2TP	144
SCMKB	205	★ SLD15L2TP	146	★ SLD2YH500L3	144
SCMKC	205	★ SLD15L2TTP	146	★ SLD2YH500L3TP	144
SCMKT	205	★ SLD15L3	146	★ SLD2YH500L7	144
SCMKW	205	★ SLD15L3T	146	★ SLD2YH500L7TP	144
SFCLT	216	★ SLD15L3TP	146	★ SLD2YH800	144
SFCLTCF	216	★ SLD15L3TTP	146	★ SLD3L1	144
SFCLTCFS	216	★ SLD15L5	146	★ SLD3L10	144
SFCLTE	216	★ SLD15L5T	146	★ SLD3L10BP	144
SFCLTS	216	★ SLD15L5TP	146	★ SLD3L1BP	144
★ SGB16A	161	★ SLD15L5TTP	146	★ SLD3L2	144
★ SGB24A	161	★ SLD15L7	146	★ SLD3L2BP	144
★ SK125I	66, 126	★ SLD15L7T	146	★ SLD3L3	144
SK12ALA	66	★ SLD15QT250	146	★ SLD3L3BP	144
★ SK165I	66, 126	★ SLD15Y200	146	★ SLD3L5	144
SK16ALA	66	★ SLD15Y300	146	★ SLD3L5BP	144
★ SK205I	66, 126	★ SLD15Y300L3	146	★ SLD3L7	144
SK20ALA	66	★ SLD15Y300L5	146	★ SLD3YH500	144
★ SK245I	66, 126	★ SLD15Y500	146	★ SLD3YH800	144
SK24ALA	66	★ SLD15Y500L3	146	SLEB250	148
★ SK325I	66, 126	★ SLD15Y500TP	146	SLEB375	148
SK32ALA	66	★ SLD15Y800	146	SLEBM6	148
★ SK405I	66, 126	★ SLD15Y800TP	146	SLEBM8	148
SK40ALA	66	★ SLD2L1	144	SLEBWS	148
★ SK485I	66, 126	★ SLD2L10	144	SLICK250	122
SK48ALA	66	★ SLD2L10BP	144	SLICK375	122
★ SK565I	66, 126	★ SLD2L1BP	144	SLICK500	122
SK56ALA	66	★ SLD2L2	144	SLLC250	148
★ SK645I	66, 126	★ SLD2L2BP	144	SLWC	148
SK64ALA	66	★ SLD2L3	144	SLWPT	148
★ SK85I	66, 126	★ SLD2L3BP	144	SMS8	173, 239
SK8ALA	66	★ SLD2L5	144	SN25	139
SL1214	148	★ SLD2L5BP	144	SN37	139
SL1518	148	★ SLD2L7	144	SN50	139
SLADCP	148	★ SLD2Y300	144	SPRA0037EG	120
SLADS	148	★ SLD2Y300L050H	144	SPRA0050EG	120
SLAFAB3	148	★ SLD2Y300L10	144	SPRC0025EG	120
★ SLD15L1	146	★ SLD2Y300L2	144	SPRC0050EG	120
★ SLD15L10	146	★ SLD2Y300L3	144	SPRD0025EG	120
★ SLD15L10T	146	★ SLD2Y300L5	144	SPRD0037EG	120
★ SLD15L10TTP	146	★ SLD2Y300L7	144	SPRD0050EG	120
★ SLD15L1T	146	★ SLD2Y500	144	SPRD0062EG	120
★ SLD15L1TP	146	★ SLD2Y500L3	144	SPRD0075EG	120



Index

SPRM2508EG	120
SPRM2511EG	120
SPRM3711EG	120
SPRM5011EG	120
SPRM5013EG	120
★ STCB6	127
STS	123
TDH	74, 142
TDHP2	142
TDHP2PR10	142
TDHT4	142
TDHT6	142
★ TEB23	150
★ TEB4	150
★ TEB6XT	150
★ TEBS1624	163
TGE	217
★ TSGB16	161
★ TSGB1624	161
★ TSGB24	161
★ TSGLDR1	162
★ TSGLDR1TC	162
TSNT0025EG	120
TSNT0037EG	120
TSNT0050EG	120
★ TSRBS1625	159
VAFT	103, 148
★ VF14	103
★ VF144TI	103
★ VF146A	103
★ VF146T	103
★ VF146TI	103
★ VF14708	103
WC812	55
★ WMX3	77
★ WMX6	77

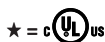

WARNING

ERICO products shall be installed and used only as indicated in ERICO's product instruction sheets and training materials. Instruction sheets are available at www.erico.com and from your ERICO customer service representative. Improper installation, misuse, misapplication or other failure to completely follow ERICO's instructions and warnings may cause product malfunction, property damage, serious bodily injury and death.

WARRANTY

ERICO products are warranted to be free from defects in material and workmanship at the time of shipment. NO OTHER WARRANTY, WHETHER EXPRESS OR IMPLIED (INCLUDING ANY WARRANTY OF MERCHANTABILITY OR FITNESS FOR A PARTICULAR PURPOSE), SHALL EXIST IN CONNECTION WITH THE SALE OR USE OF ANY ERICO PRODUCTS. Claims for errors, shortages, defects or nonconformities ascertainable upon inspection must be made in writing within 5 days after Buyer's receipt of products. All other claims must be made in writing to ERICO within 6 months from the date of shipment or transport. Products claimed to be nonconforming or defective must, upon ERICO's prior written approval in accordance with its standard terms and procedures governing returns, promptly be returned to ERICO for inspection. Claims not made as provided above and within the applicable time period will be barred. ERICO shall in no event be responsible if the products have not been stored or used in accordance with its specifications and recommended procedures. ERICO will, at its option, either repair or replace nonconforming or defective products for which it is responsible or return the purchase price to the Buyer. THE FOREGOING STATES BUYER'S EXCLUSIVE REMEDY FOR ANY BREACH OF ERICO WARRANTY AND FOR ANY CLAIM, WHETHER SOUNDING IN CONTRACT, TORT OR NEGLIGENCE, FOR LOSS OR INJURY CAUSED BY THE SALE OR USE OF ANY PRODUCT.

LIMITATION OF LIABILITY

ERICO excludes all liability except such liability that is directly attributable to the willful or gross negligence of ERICO's employees. Should ERICO be held liable its liability shall in no event exceed the total purchase price under the contract. ERICO SHALL IN NO EVENT BE RESPONSIBLE FOR ANY LOSS OF BUSINESS OR PROFITS, DOWNTIME OR DELAY, LABOR, REPAIR OR MATERIAL COSTS OR ANY SIMILAR OR DISSIMILAR CONSEQUENTIAL LOSS OR DAMAGE INCURRED BY BUYER.

ANSI is a trademark of American National Standards Institute, Inc.

ASTM is a trademark of ASTM International

cUL is a registered trademark of Underwriters Laboratories of Canada (UL Canada).

cULus is a registered trademark of Underwriters Laboratories, Inc.

ETL and Warnock Hersey are registered certification marks of ETL Semko.

The Canadian Electric Code is a copyright of The Canadian Standards Association International.

Canadian Electric Code (CEC) is a registered trademark of The Canadian Standards Association International.

ICBO standards are a copyright of the International Code Council.

ICC is a registered trademark of the International Code Council.

The National Electric Code is a copyright of The National Fire Protection Association.

National Electric Code (NEC) is a registered trademark of The National Fire Protection Association.

TIA is a registered service mark of the Telecommunications Industry Association.

UL is a registered trademark of Underwriters Laboratories, Inc.





ERICO is a leading designer, manufacturer and marketer of precision-engineered specialty metal products serving global niche product markets in a diverse range of electrical, construction, utility and rail applications. The company is headquartered in Solon, Ohio, USA with a network of sales locations serving more than 25 countries and with manufacturing and distribution facilities worldwide. ERICO's well-known brand names include: CADDY® fixings, fasteners and supports; CADWELD® welded electrical connections; CRITEC® surge protection devices; ERICO® rail bonds and specialty products; ERIFLEX® low-voltage panel components; ERITECH® electrical products; and LENTON® concrete reinforcement. Visit ERICO online at www.erico.com.

1
2
3
4
5
6
7
8
9
10
11
12
13
14
15
16
17
18
19
20

ERICO[®]



www.erico.com



AUSTRALIA

Phone 1800-263-508
Fax 1800-423-091



CHINA

Phone +86-21-3430-4878
Fax +86-21-5831-8177



HUNGARY

Phone 06-800-16538
Fax +39-0244-386-107



NORWAY

Phone 800-100-73
Fax 800-100-66



SWITZERLAND

Phone 0800-55-86-97
Fax 0800-55-96-15



BELGIUM

Phone 0800-757-48
Fax 0800-757-60



DENMARK

Phone 808-89-372
Fax 808-89-373

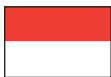

INDONESIA

Phone +62-21-575-0941
Fax +62-21-575-0942



POLAND

Phone +48-71-349-04-60
Fax +48-71-349-04-61



THAILAND

Phone +66-2-267-5776
Fax +66-2-636-6988



BRAZIL

Phone +55-11-3623-4333
Fax +55-11-3621-4066



FRANCE

Phone 0-800-901-793
Fax 0-800-902-024



ITALY

Phone 800-870-938
Fax 800-873-935



SINGAPORE

Phone +65-6-268-3433
Fax +65-6-268-1389



**UNITED ARAB
EMIRATES**

Phone +971-4-881-7250
Fax +971-4-881-7270



CANADA

Phone +1-800-677-9089
Fax +1-800-677-8131



GERMANY

Phone 0-800-189-0272
Fax 0-800-189-0274



MEXICO

Phone +52-55-5260-5991
Fax +52-55-5260-3310



SPAIN

Phone 900-993-154
Fax 900-807-333



UNITED KINGDOM

Phone +0808-2344-670
Fax +0808-2344-676



CHILE

Phone +56-2-370-2908
Fax +56-2-369-5657



HONG KONG

Phone +852-2764-8808
Fax +852-2764-4486



NETHERLANDS

Phone 0800-0200-135
Fax 0800-0200-136



SWEDEN

Phone 020-790-901
Fax 020-798-964



UNITED STATES

Phone 1-800-753-9221
Fax +1-440-248-0723