



MAXIMIZER™

The new Maximizer™ cleaning tools from Rubbermaid Commercial Products help workers save time by reducing steps in a task, reducing the time of a step and reducing user effort. Engineered to last and designed to perform in a variety of common spaces, Maximizer™ cleaning tools deliver fast, consistent results shift after shift.

Features and Benefits:

Wet/Dry Debris Pan Features & Benefits:

- Holds 10X more liquid* for efficient cleanup and less rework
- The wide, uniquely shaped pan allows liquid and solid debris to easily collect in the pan
- Molded-in baffles keep both dry and wet debris from leaking back onto floors
- Holds up to 32oz of liquid
- Constructed of durable polypropylene
- Built-in hanger bracket for easy storage of Maximizer™ Broomgee™ (sold separately)
- Durable rear wheels improve wear resistance and extend product life

Double-Sided Broomgee™ Features & Benefits:

- Double-sided Broomgee™ effectively cleans both liquid and solid spills
- Durable polypropylene bristles effectively sweep up solid debris
- Long-lasting 2.5" TPE squeegee blade handles even the toughest liquid spills
- Broomgee™ easily connects to the hanger bracket on the Wet/Dry Pan for easy storage

*vs. standard Rubbermaid Commercial Lobby Pro® debris pans

WET/DRY DEBRIS PAN & DOUBLE-SIDED BROOMGEE™

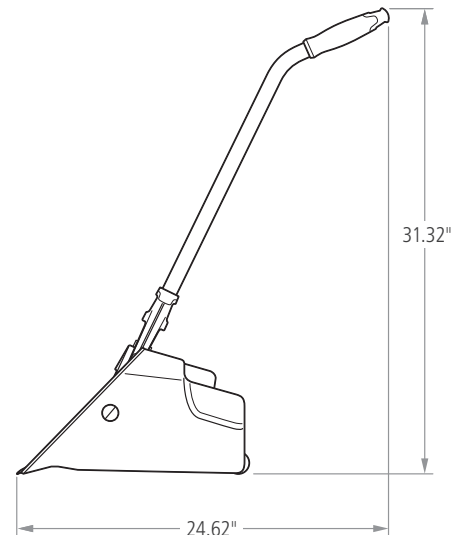
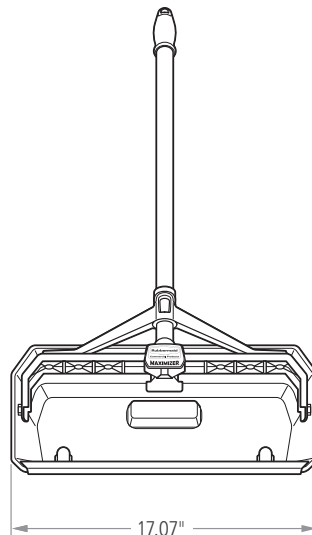
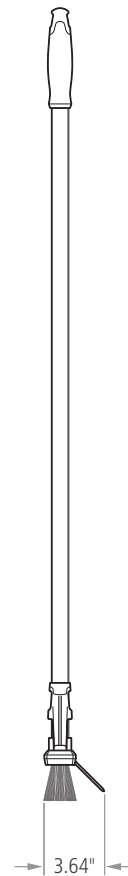
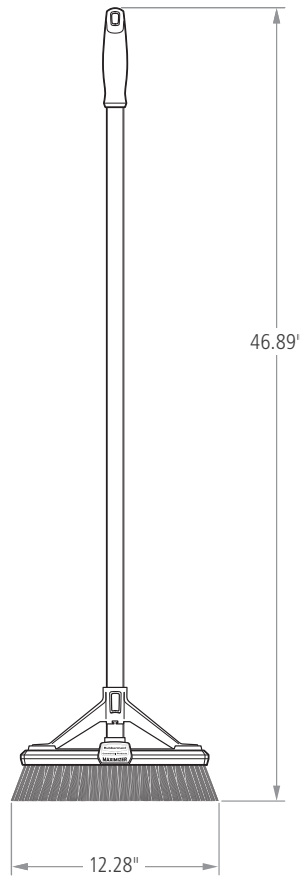

Unit Packaged Dimensions

SKU #	DESCRIPTION	COLOR	LENGTH IN	WIDTH IN	HEIGHT IN	WEIGHT LB	PACK SIZE
2018806	MAXIMIZER™ WET/DRY DEBRIS PAN	BLACK	29.00	16.88	12.00	3.20	4
2018807	MAXIMIZER™ DOUBLE-SIDED BROOM/SQUEEGEE	BLACK	44.50	4.13	7.00	1.40	8

