

**15 Amp, 125 Volts
2 Pole, 2 Wire, Non-Grounding**

IP20
SUITABILITY



**15A 125V
NEMA L1-15P
0.5 HP**

Plugs

Description	Cord Dia.	Catalog Number
Black and white nylon, polarized. Multiple drive screws.	.230"-.720" (5.8-18.3)	HBL7545C

Note: See page B-53 for accessories.

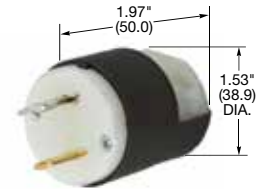

HBL7545C

Flanged Inlets

Description	Catalog Number
Nylon casing, polarized, backwired, Multiple drive screws.	HBL7524C

Note: See page B-52 for accessories.



**15A 125V
NEMA L1-15R
0.5 HP**

Connector Bodies

Description	Cord Dia.	Catalog Number
Black and white nylon. Multiple drive screws.	.230"-.720" (5.8-18.3)	HBL7506C

Note: See page B-53 for accessories.

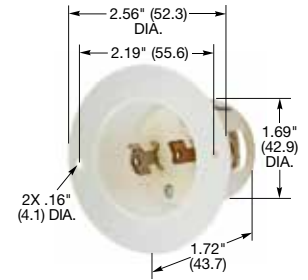

HBL7524C

Receptacles

Description	Catalog Number
Duplex, flush, black phenolic.	HBL7540
Single, flush, black phenolic.	HBL7535
Single, panel mount, 1 ⁵ / ₁₆ " (49.2) centers, black phenolic.	HBL7498

Note: See pages B-52 and B-53 for accessories.



HBL7506C

Flanged Receptacles

Description	Catalog Number
Insulgrip nylon casing, backwired. Multiple drive screws.	HBL7526C
Metal flange, stainless steel casing, black phenolic, exposed terminals.	HBL7526

Note: See pages B-52 and B-53 for accessories.
Only receptacles and plugs are HP rated.
HP ratings are AC only.

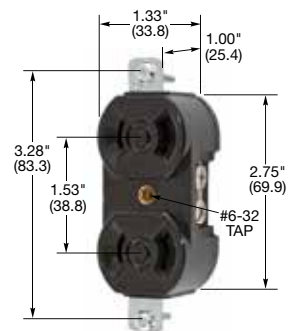

HBL7540



HBL7526C

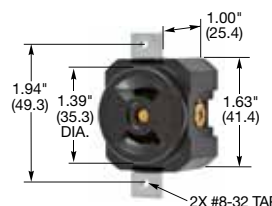

HBL7498

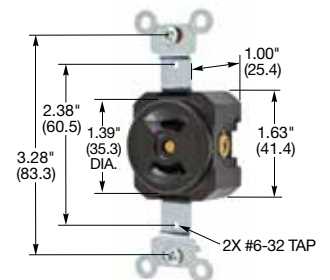

HBL7535

Dimensions in Inches (mm)