

CHEF'S CHOICE

CARLISLE
FOODSERVICE PRODUCTS



2015-2016

Carlisle Works Hard To Make Your Work Easier

Front of House

Carlisle is the leader in durable, attractive plastic tabletop ware and table coverings. From classic to festive settings, Carlisle has everything you need for interior, patio, and bar service—besides the furniture and food. We also have a wide range of display and serving ware for buffet, cafeteria, and banquet dining including portable food and beverage bars. Our attractive, durable tabletop and serving ware will save you up to 30% per year in breakage versus china and glassware.

Back Of House

Carlisle knows how challenging it can be to run a foodservice operation—consistently serving great, fresh food that is cost effectively prepared with stringent food safety practices. You can turn to Carlisle for professional food prep, storage, handling, and transport needs designed for the exacting requirement of foodservice professionals. Our wide assortment of top quality food prep tools, food pans, storage and handling supplies, and transport equipment make it easier for you to operate your business.

Food Safety & Cleaning Tools

Only Carlisle can provide you a full line of food prep & handling supplies along with cleaning tools and waste handling. We design our products to NSF food safety standards that fit into your ServeSafe® operating practices. Our Carlisle StorPlus™, Sparta® Brush, and Bronco™ brands are crafted to not only help you reduce the risk of foodborne illness outbreaks, they also help you prepare great food in the most cost effective manner. Turn to Carlisle for industry leadership in essential food preparation and cleaning tool solutions.

YOU CAN COUNT ON CARLISLE AS A TRUSTED RESOURCE FOR CRITICAL SUPPLIES ACROSS YOUR ENTIRE SITE. FROM THE BACK OF HOUSE TO THE FRONT, CARLISLE HELPS YOU DELIGHT YOUR GUESTS AND RUN A CLEAN, SAFE AND EFFICIENT FOODSERVICE OPERATION.



We're proud to be the trusted resource for your critical front of house, back of house, food safety, and cleaning tool supplies. Turn to the Carlisle catalog to help make your work easier.



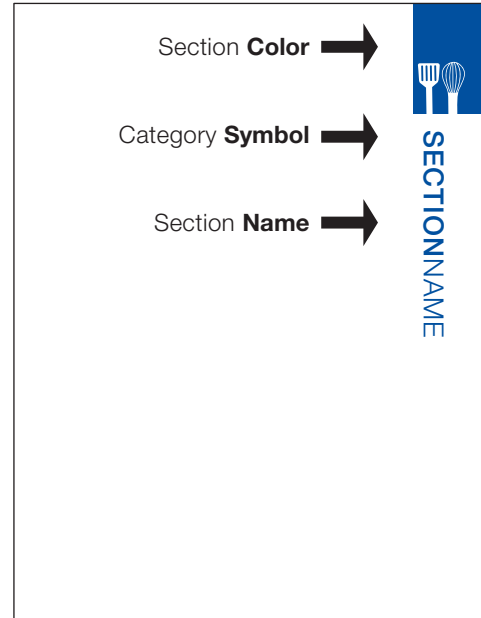

CATALOG GUIDE

- Dinnerware..... **6-27**
- Drinkware..... **28-45**
- Tabletop Accessories **46-59**
- Marko..... **60-65**
- Displayware **66-93**
- Food Bars & Convenience..... **94-117**
- Bar Supplies..... **118-133**
- Foodservice Trays..... **134-149**
- Catering Equipment **150-163**
- Professional Cookware **164-175**
- Kitchen Accessories **176-199**
- Storage & Handling **200-219**
- Warewashing **220-237**
- Cleaning Tools..... **238-259**
- Floor & Restroom Care..... **260-297**
- Transportation **298-307**
- Waste Management **308-321**
- Reference/Index **322-344**

Section Identification



Category Symbols

-  Front of House
-  Back of House
-  Sanitary Maintenance
-  Reference
-  Index

product listings on next page »

PRODUCT	PAGE	PRODUCT	PAGE	PRODUCT	PAGE
21 Key Brushes	240-241, 243	Coldmaster Coldbowl	101	Hand & Nail	256
Adapter Bars	218	Designer Displayware	76	Handle Guide	259
Bains Mariés	215, 218	Double Wall Stainless Steel	85	Iron Handle	252
Bakeware		Epicure Displayware	74	Kitchen	245
Bake Pans	172	Flared Square	69	Oven & Grill	254
Cupcake Pans	173	Food Pans	73	Racks	279
Icing Grates	175	Leaf	83	Radiator	259
Muffin Pans	173-174	Melamine Bowls	23	Scratch	255
Pie Pans	174	Microwave-Ware	24	Spouts, Pumps & Valves	249
Pullman Pans	173	Mixing	192-193	Tile & Grout	271
Loaf Pans	173	Octagon	79	Toilet Bowl Brush	295
Roast Pans	172	Orchid Deli	78	Toothbrush Style	253
Sheet Pans	173	Palette Designer Displayware	72	Utility Scrubs	245
Springform Pans	174	Palette Displayware Covers	73	Vegetable Cutter	252
Bar Accessories	125-128, 130	Pebbled	84, 91	Wok	247
Bar Caddy	126	Petal Mist	22, 82	Bud Vases	53
Bar Mat & Service Mat	127	Punch	91	Burger Cover	170
Bar & Shelf Liner	127	Rave Displayware	70	Bus Boxes & Lids	237
Barware		Roll-Top Covered	58	Caddies, Condiment & Bar	125-126
Alibi Barware	31	Salad	23, 75	Cake Covers & Tray	87
Alibi Stemware	31	Salsa	49-51	Cake & Display Stands	93, 111
Astaire Drinkware	30	Scoop	77	Carts	
Lexington Mug	41	Soup	25	Bussing/Transport	301
Liberty Drinkware	37	Square Display	86	Dish Dollies	304-305
Baskets		Stacking	83	Fold 'N Go Carts	300
Basket Server	55	Brooms		Janitorial Carts	306-307
Bread & Bun Basket	55	Angle	262	Service Carts	302
Munchie Baskets	54	Duo-Sweep	262-263	Stainless Steel Carts	302
WeaveWear Baskets & Platter	55	Dust Pans	269	Utility Carts	302-303
Wicker Look Basket	55	Floor Sweepers	269	Carafes	
Woven Baskets	54	Handle Guide	296-297	2 Cup	40
Basting Brushes	184-186	Lobby Pans	269	Cascata	40
Batter Pan	192	Lobby Pans & Broom Combos	268	Charger Plates	23
Beverage Dispensers/Servers		Natural Corn & Blend	264	Chili & Soup Servers	160
Cateraide IT	154	Racks	279	Cocktail Shakers	130
Cateraide LD Series Insulated	159	Recycled	262	Coffee Mugs	41
Cateraide Slide 'N Seal Insulated	156	Straight	263	Coffee Service	
Cateraide XT Series Insulated	158	Synthetic Corn	264	Cheese Shaker/Sugar Pourer	52
Round Beverage Dispenser	117	Brushes & Scrubs		Creamer/Pitchers	52
Square Beverage Dispenser	117	Atlas Multi-Purpose	244	Drip Trays, NeWave	93
TrimLine Rectangular	116-117	Bake Pan Lip	252	Sugar Caddies	52
Bins, Ingredient	219	Bottle & Jar	250	Colanders & Strainers	192-194
Booster Seats	59	Butcher Block	253	Coldmaster Products	
Bottle, Oil and Sprayer	199	Coffee Service	249	CaterCooler	160
Bottle Holders	124, 132	Counter Top	259	Coldmaster Batter Pan	192
Bottle Pourers	122-123, 128-129	Cutting Board	244	Coldmaster Coldbowl	101
Bowls		Dish	251	Coldmaster Coldcrook & Accessories	100
Allegro Display	86	Equipment	247-248, 253	Coldmaster Coldpans	99
Balsam Display	68	Ergonomic Hand Scrubs	246	Coldmaster Condiment Bar	
Balti	86	General Clean Up	246	Organizers	101
Bell	83	Glass Washing	250	Coldmaster CoolCheck	96-97
Clam Shells	83	Grill Bricks	255	Coldmaster Dispenser	101

PRODUCT	PAGE	PRODUCT	PAGE	PRODUCT	PAGE
Coldmaster Ice Cream Server & Lid	21, 100	Square	14	Scalloped DeliWare & Inset	75
Coldmaster Standard Food Pans & Lids	98	Terra	14	Scoop Bowl	77
Condiment Bars & Accessories	101, 103	Dish Dollies, Optimizer	304-305	Square Display Dishes	86
Condiment Caddies	125-126	Dish Racks		Stacking Bowls	83
Condiment Organizers	112, 115, 125-126	All-Purpose Plate & Tray Rack	231	Stands	93
Condiment Pumps	100, 103, 112	Combination/Flatware Rack	230	Terra Displayware	71
Containers		Cup Racks	231	Tulip Deli Crocks	78
Bains Maries	215-218	Dollies	233	Disposable Lids	44-45
Crocks	102	Dust Cover	233	Double Boiler	170
Food Boxes	210-211	Food Pan Rack	231	Drain Grates	218
Food Pans	96-99	Open/Bowl Racks	230	Dredges/Powder Cans	193
Rounds	214	Peg Racks	230	Drinkware	30-39, 41
Squares	212-213	Plaque-A-Rack System	234-235	Drip Trays	93
Cookware		Rack Cover	233	Dust Pans & Lobby Brushes	268
Braziers	168	Dishers	189	Dusters	258
Covers	170-171	Dishes, Roll-Top	58	Electric Kettle	25
Double Boiler	170	Dispensers		End Loaders	
Fry Pans	166-167	Counter Top Lid & Straw Dispenser	115	Cateraide IT	155
Mesh Baskets	170	Cup Dispensers	114	Cateraide Slide 'N Seal	157
Sauce Pans	169	Straw Dispenser	115	CaterCooler	160
Sauté Pans	169	Toothpick Dispenser	115	Dollies	162
Sectional	169	Display Cases, Pastry	111	Insulated	161
Stock Pots	168	Display Cubes	92	Floor Brushes	
Covers		Display Stands	93	Dual Surface Brushes	270
Burger	170	Displayware		Handle Guide	296-297
Cake	87	Allegro Display Bowls	86	Handles	276-278
Compartment Tray	144	Balsam	68	Racks	279
Cookware	170-171	Balti Dishes	86	Scrubs	270
Custom, Plate	27	Bell Bowls	83	Swivel Floor Brushes	270
Display	87	Clam Shells	83	Tile & Grout Brushes	271
Palette Displayware	73	Designer Displayware	76	Floor Maintenance	
Pastry Tray	144	Double-Wall Stainless Steel		Boot 'N Shoe Brush	295
Plate	26	Displayware	85	Caution Barriers & Cones	291
Crocks		Epicure Displayware	74	Floor Drain Brush	294
Classic Crock Condiment Station	103	Flared Square Bowls	69	Floor Drain Opener	294
Classic Crocks	102	Leaf Bowls	83	Floor Sweepers	269
Gourmet Crocks	103	MirAcryl Cubes	92	SpillEater Absorbent	292-293
Poly-Tuf Crocks	102	Mirrored Trays	92	Wet Floor Signs	291
Supreme Crocks	103	Modular Displayware	80	Floor Rack System	219
Cup Dispensers	114	Narrow Rimmed	74	Floor Squeegees	
Cutting Boards & Accessories	178-179	Octagon Bowls	79	Double Foam Squeegees	272-273
Dessert Dishes	21	Octagonal Crocks	79	Handle Guide	296-297
Dinnerware		Orchid Deli Bowls	78	Handles	276-278
Commercial, Polycarbonate	20	Palette Designer Displayware	72	Racks	279
Dallas Ware	16-17	Pebbled Bowls	84	Rubber Squeegees	274-275
Dayton	8-9	Petal Mist	82	VersaClean Brush & Squeegees	276
Durus	12-13	Plate Stands	77	Floor Sweeps	
Epicure	15	Rave Displayware	70	All Purpose Omni Sweep	265
Kingline	18-19	Rectangular Crocks & Platter	81	Fine Floor Sweeps	266
Sierrus	10-11	Risers	87	Handle Guide	296-297
		Salad Bowl	75	Handles	276-278
		Scalloped Platters	71	Heavy Floor Sweeps	267

continued on next page »

PRODUCT	PAGE	PRODUCT	PAGE	PRODUCT	PAGE
Medium Floor Sweeps	266	Ice Sculptures	90	Pullman Pans	173
Multi-Surface Floor Sweeper	269	Ice Totes, Containers	183	Loaf Pans	173
Racks	279	Icing Grates	175	Roast Pans	172
Sweep Complete	265	Insets, Stainless	219	Sheet Pans	173
Food Bars		Insulated Food		Springform Pans	174
Adapter Bars	218	Pan Carriers152-153, 155, 157, 160-161		Pasta Cookers, Sectional	169
Buffet Bars	110	J-Jars	53	Pasta Forks	104-105
Five-Star	110	Janitorial Carts & Accessories	306-307	Pastry Brushes	184-186
Maximizer	106-107	Ladles	88, 105, 195	Pastry Display Cases	111
Six-Star	108-109	Lid & Condiment Organizer	115	Pastry Tray Covers	144
Sneeze Guards	110	Liquor Pourers	128-129	Peeler	199
Tabletop	108-110	Lobby Pans	268-269	Pitchers	42-43, 52
Youth	108-109	Measurers		Plate Covers	
Food Boxes & Containers		Commercial	188	Custom Plate Covers	27
Bains Maries	215, 218	Dishers	189	Polycarbonate Plate Covers	26
Color-Coded	210-211	Measure Misers	189-191	Polyglass Plate Covers	26
Economical Space Saver	213	Measuring Cups	188	Plate Stands	77
Food Storage Boxes & Lids	210-211	Measuring Spoons	188	Plates	
Insets	219	One Gallon Containers	187	Charger	23
Round Containers & Lids	214	Portioning Cups	187	Leaf	22
Square Containers & Lids	212-213	Microfiber Cloths	257	Petal Mist	22, 82
Food Pans		Microwave Ware	24	Portable Bar & Accessories	120-121
Coldmaster Food Pans	96-99	Mixing Bowls	192-193	Powder Cans & Dredges	193
Drain Grates	218	Money Maid Combo Packs	145	Pump Kit	112
Drain Shelves	206-209	Mop Buckets	290	Punch Bowls	91
DuraPan Food Pans & Accessories	216-218	Mops & Accessories		Ramekins	
High Heat Pans	204-205, 207	Cut-End Mops	286-287	Butter Dish	49
Palette Designer Displayware Pans	73	Dust Mops	281	Japanese Style	49
Polycarbonate Pans	204-206	Looped-End Mops	284-286	Melamine	50
Polypropylene Pans	204-205, 208	Microfiber Mops	280	Molcajete	50
Smart Lids	204	Microfiber Bucket	281	Oval	48
Specialty Food Pans	209	Mop Bucket & Wringer Combos	290	Salsa Dishes	50
Universal Food Pan Lids	204	Mop Guide	282-283	SAN	51
Food Preparation Brushes	187	Mop Handles	288-289	Sauce Cups	51
French Whips	198	Screw Top Mops	287	Scalloped	49
Fry Pans	166-167	Sponge Mops	288	Square	48
Fryer Baskets	170	Muffin Pans	175	Stainless Steel	51
Glass Rack Sizing Guide	225	Mugs, Coffee	41	Straight Sided	48
Glass Rimmers	128	Number Stands	59	Rectangular Microfiber Bucket	281
Gravy Boats	53	Order Racks	182	Recycle Containers & Lids	318-319
Grill Bricks, Screens	255	Order Wheels	182	Recycle Lable Kit	319
Hand & Nail Brushes	256	Oven/Broiler Brushes, Scrapers	254-255	Replacement Parts	328-333
Handles & Accessories	262-263, 276-279, 288-289	Packet Racks	112	Restroom Maintenance	
Handle Guide	296-297	Paddle Scrapers	196	Bowl Brushes	295
Heat Lamps	180-181	Pails, Cleaning, Disinfecting	257	Force Cup	295
Ice Buckets & Caddies	132-133, 163	Pan Carriers	155, 156, 160-161	Risers	87
Ice Caddies, Cateraide	163	Pans, Baking		Salad Bars	106-110
Ice Cream Server & Lid, Coldmaster	21, 100	Bake Pans	172	Salsa Dishes & Bowls	50-51
Ice Only Container	183	Cupcake Pans	173	Sauce Cups	51
Ice Scoops	133, 183	Icing Grates	175	Scoops	133, 183
		Muffin Pans	173-174	Scrapers	196-197, 258
		Pie Pans	174	Scrubs, Sponges	251

PRODUCT	PAGE	PRODUCT	PAGE	PRODUCT	PAGE
Server, Tortilla	56-57	Top Loaders		Crystalon Stack-All	35
Servers, Tiered	93	Cateraide IT	155	Genuine Coca-Cola	33, 36
Service Mat & Bar Mat	127	Cateraide Slide 'N Seal	157	Lafayette	39
Serving Spoons, Buffet Spoons & Pasta Forks	88, 104-105, 198	CaterCooler	160	Lorraine	34
Serveware	88	Dollies	162	Louis	34
Shaker/Dredge	52, 193	Insulated	161	Pebble Optic	36
Shakers, Cocktail	130	Topping Rails	113	Pepsi	33
Sheet Pan Carriers	161	Tortilla Servers	56-57	Stackable	32-33, 38
Shelf Liner & Bar Mat	127	Tote Boxes & Lids	236	Swirl	39
Shelves, Drain	206-209	Trays		Turners	88, 198
Shovels	199	Bakery	138-139	Vases, Bud	53
Skimmers, Wire Mesh	194	Bar	146-147	Warewashing Racks & Accessories	
Sneeze Guards	110	Bistro	141	Color-Coded	223-224, 226-229
Soup & Chili Servers	160	Café	141	Dish	230-231
Soup Server, Electric	25, 111	Cake	87	Dollies	233
Soup Service	25	Carrier, Insulated	161	Dust Cover	233
Spatulas	196-197	Celebration, Chrome Plated	148	Flatware	232
Specialty Racks	230-232	Compartment	142-144	Glass	223-224, 226-229
Speed-Rak Bottle Holders	124	Cork	147	Glass Rack Sizing Guide	225
Sponges, Scour Pads	251	Covers	144	NeWave	223
Spoons	88, 104-105, 198	Display	138-139	OptiClean Rack System	222
Spouts	122-123, 128-129	Drip	93	Placque-A-Rack System	234-235
Spouts, Pumps,		Euronorm	138-139	Rack Cover	233
Valves	100-101, 103, 112-113	Festival	149	Specialty	230-232
Squeegees		Fiberglass	136-140	Waste Containers	
Floor	272-275	Glasteel	136-139	50-Gallon Roll Away	313
Window	258	GripLite	147	56 Gallon	313
Stands, Number	59	Griptite	146	Bronco & Lids	310-311
Steak Weight	199	Handled	141	Centurian	314
Step Risers	87	Heavy Weight	149	Compost	319
Steri- & Suds-Pails	257	Illuminated	90	Dollies	311, 315
Store 'N Pour		Low Edge	138	Fire Resistant	317
PourPlus	122	Market	140	Hot Stamped	311
Complete Units & Backups	123	Metric	138-139	Office Wastebaskets	317
Condiment System	126	MirAcryl Display	92	Recycle Containers & Accessories	318-319
Speed Spout	123	Octagonal	148	Square Bronco	312
Bar Service Pack	123	Oval	146-148	Step-On	316
Strainers & Colanders	192-194	Petal Mist	82	Tool Caddy Bag	311
Straw Dispenser	115	Polycarbonate	140	TrimLine	315
Sugar Caddies	52	Racks	230	Wet Floor Sign	291
Sugar Pourer/Cheese Shaker	52	Rectangular	138-139, 146, 148	Whips, French	198
Suds-Pails	257	Room Service	145	Window Maintenance	
Syrup Pitchers	52	Round	58, 146-149	Squeegees	258
Ticket Wheels	182	Serving	58	Scrapers	258
Tilt Trucks	320-321	Stainless Steel	149	Wine Buckets & Stands	131
Timer	199	Stands	149	Wine Holder	132
Tip Trays	145	Tip	145	Wine Servers & Coolers	130, 132
Tongs	88-89, 104, 194	Trapezoid	138-139, 141	Wire Mesh Baskets	170
Tool Caddy	307	Tulip Dishes	21	Wire Mesh Skimmers	194
Toothpick Dispenser	115	Tumblers			
		Bistro	35		
		Crystalon RimGlow	38		



CARLISLE
FOODSERVICE PRODUCTS

ELEGANT VERSATILE DURABLE BEAUTIFUL **DINNERWARE**

Carlisle offers a wide array of guest pleasing dinnerware choices that can coordinate with every type of venue and cuisine. Set your table with Carlisle and watch the savings stack up vs. traditional porcelain dinnerware. Our durable collections are designed to be beautiful and long-lasting.



MELAMINE DINNERWARE

As the sustainability trend continues to grow, sourcing fresh local food and using minimally invasive products in the front-of-house are more important than ever. **Dayton was designed with the environment in mind.** Make the eco friendly choice. Choose Dayton.

DINNERWARE

Dayton™









- One of the most eco-friendly commercial grade melamines available on the market
- Classic design is available in 10 stylish colors
- Meets PS25-70 specifications insuring the weight, purity, and quality of our melamine
- Made from 50% sustainable natural resources vs 20% in standard melamine
- Contains a material that will begin to biodegrade in 90 days in a compostable environment
- Withstands the rigors of commercial foodservice dishwasher use
- Maintains its appearance after one year of dishwasher testing
- Dayton melamine is stain, scratch, and break-resistant, making it ideal for any foodservice operation
- Safe for temperatures up to 212° F
- Dishwasher safe



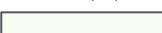

10 GREAT COLORS



 Black(03)	 Red(05)	 Oatmeal(06)	 Honey Yellow(22)	 Truffle(31)
 Bavarian Cream(37)	 Peppercorn(40)	 Toffee(43)	 Turquoise(63)	 Wasabi(82)

Prod No	Description	Color	Pack	Cs Wt/Cube
Dayton Dinnerware Plates & Platters				
4385	10.25" Dinner Plate	03, 05, 06, 22, 31, 37, 40, 43, 63, 82	48 ea	34.89/1.42
43852	9" Dinner Plate	03, 05, 06, 22, 31, 37, 40, 43, 63, 82	48 ea	27.29/0.82
43854	7.25" Salad Plate	03, 05, 06, 22, 31, 37, 40, 43, 63, 82	48 ea	17.18/0.44
43856	5.63" Bread & Butter Plate	03, 05, 06, 22, 31, 37, 40, 43, 63, 82	48 ea	10.68/0.30
43872	9.25" x 6.25" Oval Platter	03, 05, 06, 22, 31, 37, 40, 43, 63, 82	24 ea	10.66/0.33
Dayton Dinnerware Bowls & Cup				
43858	16 oz, 5.75" Nappie Bowl	03, 05, 06, 22, 31, 37, 40, 43, 63, 82	48 ea	16.95/0.87
43860	14 oz, 5.5" Rim Nappie Bowl	03, 05, 06, 22, 31, 37, 40, 43, 63, 82	24 ea	8.74/0.45
43862	10 oz, 5" Nappie Bowl	03, 05, 06, 22, 31, 37, 40, 43, 63, 82	48 ea	11.14/0.50
43864	10 oz, 5.88" Grapefruit Bowl	03, 05, 06, 22, 31, 37, 40, 43, 63, 82	48 ea	15.01/0.62
43866	4.75 oz, 4.5" Fruit Bowl	03, 05, 06, 22, 31, 37, 40, 43, 63, 82	48 ea	7.37/0.31
43868	8 oz, 3.75" Bouillon Cup	03, 05, 06, 22, 31, 37, 40, 43, 63, 82	24 ea	5.32/0.18

Note: Melamine Dinnerware is not recommended for microwave

MELAMINE DINNERWARE

Dress your dining table with the **beauty and feel of porcelain** at a fraction of the price. Sierrus Dinnerware is a **medium weight** version of our popular Durus design. Mix and match Durus with Sierrus to make your budget go farther.



DINNERWARE

Sierrus™

- All purpose, medium-heavy weight dinnerware has the same design as our Durus® line
- Available in eight solid colors
- Sierrus Dinnerware offers a two-year warranty against breakage
- Made of heavy-duty, break-resistant melamine
- Safe for temperatures up to 212°F
- NSF Listed; dishwasher safe



White(02)	Black(03)	Red(05)	Meadow Green(09)
Ocean Blue(14)	Honey Yellow(22)	Bone(42)	Sunset Orange(52)

Prod No	Description	Color	Pack	Cs Wt/Cube
Sierrus Narrow Rim Plates				
33000 Δ	10.5" 3-Compartment Plate	02, 03, 05, 09, 14, 22, 42, 52	12 ea	9.66/0.39
33002 Δ	10.5" Dinner Plate	02, 03, 05, 09, 14, 22, 42, 52	12 ea	9.19/0.33
33004 Δ	9" Dinner Plate	02, 03, 05, 09, 14, 22, 42, 52	24 ea	15.00/0.66
33006 Δ	7.25" Salad Plate	02, 03, 05, 09, 14, 22, 42, 52	48 ea	19.01/0.61
33008 Δ	6.5" Pie Plate	02, 03, 05, 09, 14, 22, 42, 52	48 ea	15.84/0.56
Sierrus Wide Rim Plates				
33024 Δ	12" Dinner Plate	02, 03, 05, 09, 14, 22, 42, 52	12 ea	11.46/0.44
33010 Δ	10.5" Dinner Plate	02, 03, 05, 09, 14, 22, 42, 52	12 ea	10.51/0.40
33012 Δ	9" Dinner Plate	02, 03, 05, 09, 14, 22, 42, 52	24 ea	15.05/0.62
33016 Δ	7.5" Salad Plate	02, 03, 05, 09, 14, 22, 42, 52	48 ea	21.33/0.71
33018 Δ	6.5" Pie Plate	02, 03, 05, 09, 14, 22, 42, 52	48 ea	15.63/0.57
33020 Δ	5.5" Bread & Butter Plate	02, 03, 05, 09, 14, 22, 42, 52	48 ea	11.66/0.41

NSF Listed products are designated with a Δ and may be prefixed with an N
 Note: Melamine Dinnerware is not recommended for microwave



Carlisle Mugs

Our new Carlisle Mugs pair perfectly with the color options of Sierrus Dinnerware.

See page 41 for more information on these great mugs.



White(02)	Black(03)	Red(05)	Meadow Green(09)
Ocean Blue(14)	Honey Yellow(22)	Bone(42)	Sunset Orange(52)

Prod No	Description	Color	Pack	Cs Wt/Cube
Sierrus Platters				
33080 Δ	13.5" x 10.5" Oval Platter	02, 03, 05, 09, 14, 22, 42, 52	12 ea	12.94/0.48
33082 Δ	12" x 9.25" Oval Platter	02, 03, 05, 09, 14, 22, 42, 52	12 ea	10.06/0.42
33086 Δ	9.5" x 7.25" Oval Platter	02, 03, 05, 09, 14, 22, 42, 52	24 ea	12.25/0.52
Sierrus Bowls & Cup				
33030 Δ	20 oz, 12" Chef Salad/Pasta Bowl	02, 03, 05, 09, 14, 22, 42, 52	12 ea	11.72/0.53
33032 Δ	16 oz, 7.5" Rimmed Bowl	02, 03, 05, 09, 14, 22, 42, 52	24 ea	10.82/0.46
33034 Δ	13 oz, 9.25" Pasta/Soup/Salad Bowl	02, 03, 05, 09, 14, 22, 42, 52	24 ea	17.16/0.66
33036 Δ	12 oz, 7.25" Rimmed Bowl	02, 03, 05, 09, 14, 22, 42, 52	24 ea	13.15/0.54
33038 Δ	10 oz, 5.38" Rimmed Nappie Bowl	02, 03, 05, 09, 14, 22, 42, 52	24 ea	8.34/0.49
33040 Δ	6 oz, 6" Rimmed Bowl	02, 03, 05, 09, 14, 22, 42, 52	48 ea	8.50/0.52
33042 Δ	4.5 oz, 4.75" Rimmed Fruit Bowl	02, 03, 05, 09, 14, 22, 42, 52	48 ea	9.40/0.41

NSF Listed products are designated with a Δ and may be prefixed with an N

Note: Melamine Dinnerware is not recommended for microwave

MELAMINE DINNERWARE

Durus looks and feels like porcelain dinnerware without the replacement costs due to chipping or breaking. **Switch to Durus and watch the savings pile up!**



See page 334 for complete warranty information

DINNERWARE

Durus®

- High quality, heavy-weight melamine dinnerware has the look and feel of china without the replacement cost
- Available in 11 solid colors
- Minimize your scratch and stain problems with our exclusive mirror-like glaze
- See a return on investment in less than 18 months in most operations after switching to Durus from china
- Reduce dinnerware drying time with the advanced Durus foot design and slick water-sheeting glazed surface
- Save money with our Durus four-year warranty* against breakage, the best guarantee in the industry
- Mix and match Durus side dishes with china plates for a beautiful tabletop that costs less to maintain
- Durus dinnerware can be decorated, see page 326 for details
- Safe for temperatures up to 212°F
- NSF Listed; dishwasher safe



Coordinating Tumblers, Ramekins & Soup Bowls are also shown below
Additional information on coordinating pieces can be found in the Drinkware & Tabletop Accessories catalog sections



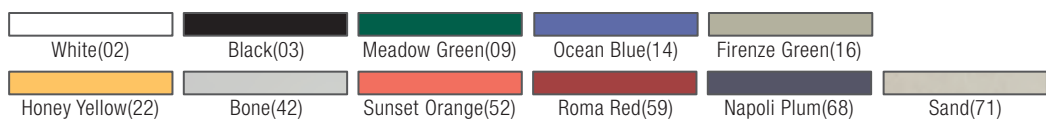

Prod No	Description	Color	Pack	Cs Wt/Cube
Durus Narrow Rim Plates				
43000 Δ	10.5" 3-Compartment Plate	42	12 ea	12.15/0.46
43002 Δ	10.5" Dinner Plate	02, 09, 14, 22, 42, 52	12 ea	11.30/0.41
43004 Δ	9" Dinner Plate	02, 09, 14, 16, 22, 42, 52, 58, 68, 71	24 ea	20.80/0.85
43006 Δ	7.25" Salad Plate	02, 09, 14, 22, 42, 52	48 ea	25.10/0.78
43008 Δ	6.5" Pie Plate	02, 03, 09, 14, 22, 42, 52, 71	48 ea	21.60/0.66
Durus Wide Rim Plates				
43024 Δ	12" Dinner Plate	02	12 ea	18.10/0.54
43010 Δ	10.5" Dinner Plate	02, 14, 22, 42, 52	12 ea	12.30/0.42
43012 Δ	9" Dinner Plate	02, 03, 09, 14, 22, 42, 52	24 ea	20.25/0.76
43016 Δ	7.5" Salad Plate	02, 42	48 ea	26.90/0.96
43018 Δ	6.5" Pie Plate	02, 14, 42	48 ea	20.64/0.70
Durus Oval Platters				
43080 Δ	13.5" x 10.5" Oval Platter	02, 09, 14, 22, 42, 52, 71	12 ea	15.00/0.59
43082 Δ	12" x 9.25" Oval Platter	02, 03, 09, 14, 16, 22, 42, 52, 58, 71	12 ea	14.10/0.55
43086 Δ	9.5" x 7.25" Oval Platter	02, 03, 09, 22, 42, 52,	24 ea	18.00/0.60
Durus Bowls & Cup				
43030 Δ	20 oz, 12" Chef Salad/Pasta Bowl	02, 03, 09, 14, 22, 42, 52, 58	12 ea	16.30/0.71
43032 Δ	16 oz, 7.5" Rimmed Bowl	02, 03, 09, 14, 22, 42, 52	24 ea	14.10/0.58
43034 Δ	13 oz, 9.25" Pasta/Soup/Salad Bowl	02, 09, 14, 22, 42, 52, 58, 68	24 ea	21.60/0.82
43036 Δ	12 oz, 7.25" Rimmed Bowl	02, 09, 14, 22, 42, 52, 71	24 ea	16.10/0.62
43038 Δ	10 oz, 5.38" Rimmed Nappie Bowl	02, 09, 14, 22, 42, 52	24 ea	11.50/0.52
43040 Δ	6 oz, 6" Rimmed Bowl	02, 09, 14, 22, 42, 52	48 ea	21.45/0.72
43042 Δ	4.5 oz, 4.75" Rimmed Fruit Bowl	02, 09, 14, 16, 22, 42, 52, 58, 71	48 ea	12.86/0.42
43050 Δ	7 oz, 4" Bouillon Cup	02, 03, 09, 14, 22, 42, 52, 71	48 ea	12.20/0.75

NSF Listed products are designated with a Δ and may be prefixed with an N
 Note: Melamine Dinnerware is not recommended for microwave

DINNERWARE ACCENT PIECES

Terra™

Terra Dinnerware Accents offer the exotic and earthy look of hand thrown pottery with the break resistance of heavy duty melamine. The organic design blends in with many food presentations and styles.

- The look of heavy-weight, hand thrown pottery blends into a variety of settings and offers an exceptional presentation
- Constructed of a unique, break-resistant material with the look and feel of ceramic
- Safe for temperatures up to 212°F
- NSF Listed; dishwasher safe



Square

As a tasting plate, an accent dish or the foundation for a grand buffet, square plates are on trend. Our square plates have rounded edges and the fine look of porcelain.

- Squares offer the look of ceramics in long-wearing melamine
- Three sizes hold everything from salads and appetizers to buffet style presentations
- Squared rim design is a sleek take on a classic look
- Made of heavy-duty, break-resistant melamine
- Safe for temperatures up to 212°F
- NSF Listed; dishwasher safe



Square Scoops

- Scoop shaped design holds sauces as well as appetizers or side dishes



Prod No	Description	Color	Pack	Cs Wt/Cube
Terra Dinnerware				
43404 ▲	9.5" Terra Dinner Plate	03	12 ea	15.20/0.60
43410 ▲	9" Terra Square Plate	02,03	24 ea	21.60/0.84
43420 ▲	58 oz, 9.75" Terra Footed Bowl Pack	02,03	12 ea	20.60/1.05
43422 ▲	40 oz, 8.5" Terra Footed Bowl	02,03	12 ea	21.20/0.76
Square Dinnerware				
43308 ▲	8" Square Plate	02,03	48 ea	22.75/0.48
43306 ▲	9.5" Square Plate	02,03	48 ea	34.68/0.71
43304 ▲	11.5" Square Plate	02,03	48 ea	46.51/1.03
Square Scoops				
7940 ▲	2 oz, 3.5" Small Square Dish	02, 03	48 ea	7.12/0.21
7942 ▲	5 oz, 5.25" Small Square Dish	02, 03	48 ea	12.93/0.47

NSF Listed products are designated with a ▲ and may be prefixed with an N





Epicure®

The elegant coupe shape is the perfect frame for larger plating creations. Epicure's coupe shape lends European appeal in durable melamine.

- European coupe design combines strength and beauty with functionality
- Coupe design offers larger serving area
- Safe for temperatures up to 212°F
- NSF Listed; dishwasher safe

Epicure® Shapes Tasting Plates

- One of a kind shapes add variety when serving appetizers, desserts, or specialty foods



Prod No	Description	Color	Pack	Cs Wt/Cube
Epicure Dinnerware				
43800 Δ	12" Buffet/Pizza Plate	02	12 ea	12.50/0.74
43801 Δ	10" Dinner Plate	02	48 ea	29.15/1.28
43803 Δ	8" Dinner Plate	02	48 ea	15.98/0.67
5933 Δ	32 oz, 8.25" Vegetable Bowl	02	24 ea	17.75/1.28
43813 Δ	36 oz, 8" Chef Salad/Serving Bowl	02	12 ea	5.95/0.38
43814 Δ	20 oz, 6.5" Soup/Salad Bowl	02	12 ea	4.00/0.18
Epicure Shapes				
43806 Δ	11" TriArc Plate	02, 03	4 ea	3.60/0.21
43822 Δ	6.25" Square Plate	02	48 ea	26.30/0.68

NSF Listed products are designated with a Δ and may be prefixed with an N



MELAMINE DINNERWARE

Dallas Ware set the industry standards by which all others are judged. **Quality and durability have been the Dallas Ware trademark for over 50 years.** The NSF listing on all Dallas Ware items ensures the highest sanitary standards.

Dallas Ware®

- Dallas Ware, the original industry standard for melamine dinnerware, offers superior stain and scratch resistance
- Reinforced rim and foot design stacks with major competitors' products
- Meets PS25-70 specifications
- Safe for temperatures up to 212°F
- NSF Listed; dishwasher safe

Tabletop Accessories available in coordinating colors. See page 50 for more details



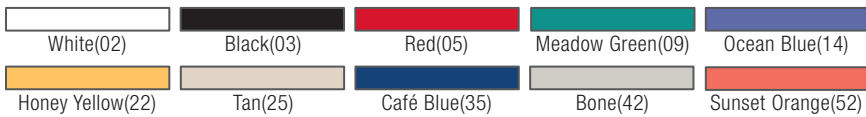

Prod No	Description	Color	Pack	Cs Wt/Cube
Dallas Ware Narrow Rim Plates				
43500 Δ	10.25" Dinner Plate	02, 03, 05, 09, 14, 22, 25, 35, 42, 52	48 ea	39.60/1.63
43501 Δ	9" Dinner Plate	02, 03, 05, 09, 14, 22, 25, 35, 42, 52	48 ea	26.55/0.99
43503 Δ	7.25" Salad Plate	02, 03, 05, 09, 14, 22, 25, 35, 42, 52	48 ea	16.20/0.51
43504 Δ	6.5" Pie Plate	02, 25	48 ea	12.80/0.42
43505 Δ	5.63" Bread & Butter Plate	02, 25, 35	48 ea	9.80/0.31
Dallas Ware Compartment Plates				
43512 Δ	11", 1" D, 3-Compartment Plate	35	48 ea	37.60/1.60
43514 Δ	9.75", 1" D, 3-Compartment Plate	25, 35	36 ea	27.80/1.56
43516 Δ	9", 1.31" D, 3-Compartment Plate	02, 25	24 ea	20.05/1.20
Dallas Ware Oval Platters				
43560 Δ	12" x 8.5" Oval Platter	02, 03, 25, 35	24 ea	15.00/0.76
43563 Δ	9.25" x 6.25" Oval Platter	02, 03, 25, 35, 42	24 ea	10.44/0.37
Dallas Ware Bowls				
43520 Δ	16 oz, 5.75" Nappie Bowl	02, 25	48 ea	16.50/0.93
43521 Δ	14 oz, 5.5" Nappie Bowl	02, 03, 05, 09, 14, 22, 25, 35, 42, 52	48 ea	13.75/0.66
43522 Δ	14 oz, 5.5" Rim Nappie Bowl	02, 25, 35	24 ea	8.00/0.47
43525 Δ	13 oz, 5.25" Nappie Bowl	02, 25, 35	24 ea	6.30/0.33
43528 Δ	10 oz, 5" Nappie Bowl	02, 25, 35	48 ea	11.10/0.54
43529 Δ	10 oz, 5.88" Grapefruit Bowl	02, 03, 05, 09, 14, 22, 25, 35, 42, 52	48 ea	14.83/0.67
43531 Δ	4.75 oz, 4.5" Fruit Bowl	02, 25, 35	48 ea	7.10/0.40
43532 Δ	3.5 oz, 4.13" Fruit Bowl	02, 03, 05, 25, 35	48 ea	6.20/0.29
43533 Δ	6.5 oz Oval Fruit Dish	02	48 ea	10.25/0.41
43540 Δ	8 oz, 3.75" Bouillon Cup	02, 03, 05, 09, 14, 22, 25, 35, 42, 52	24 ea	4.45/0.19

NSF Listed products are designated with a Δ and may be prefixed with an N
 Note: Melamine Dinnerware is not recommended for microwave

MELAMINE DINNERWARE

Kingline is the top choice for **heavy-duty applications like school cafeterias.** Our medium weight melamine offers **beauty and durability at a great value.**

Kingline™

- All purpose, medium weight dinnerware meets the tough requirements of heavy-duty foodservice applications
- Durable gloss finish resists chipping, scratching, and staining
- Reinforced at vital stress points
- Save even more money with our exclusive Sandshades® variegated dinnerware
- Safe for temperatures up to 212°F
- NSF Listed; dishwasher safe

TOP CHOICE FOR SCHOOLS



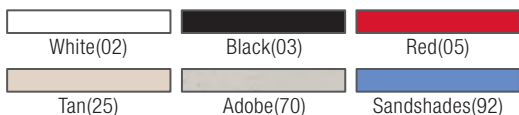

Prod No	Description	Color	Pack	Cs Wt/Cube
Kingline Plates				
KL116 Δ	10" Dinner Plate	02, 03, 25	48 ea	25.80/1.07
KL200 Δ	9" Dinner Plate	02, 03, 05, 25, 70	48 ea	19.20/0.88
KL920 Δ	9" Dinner Plate	92	48 ea	18.50/0.82
KL201 Δ	7.25" Sandwich Plate	02, 03, 05, 25	48 ea	12.20/0.56
KL204 Δ	6.5" Pie Plate	02, 03, 05, 25	48 ea	11.35/0.40
KL205 Δ	5.5" Bread & Butter Plate	02, 25, 70	48 ea	8.65/0.28
Kingline Compartment Plates				
KL102 Δ	10", .75" D, 3-Compartment Plate	02, 25, 70	48 ea	24.30/1.23
KL203 Δ	8.75", 1.25" D, 3-Compartment Plate	02, 25	12 ea	7.85/0.57
Kingline Oval Platters				
KL126 Δ	13.5" x 9.75" Oval Platter	02, 25	12 ea	10.40/0.55
KL127 Δ	12" x 9" Oval Platter	02, 03, 05, 25, 70	12 ea	8.90/0.42
Kingline Bowls & Cup				
KL350 Δ	8 oz Bouillon Cup	02, 03, 05, 25	48 ea	8.20/0.54
KL115 Δ	16 oz, 6.13" Chowder Bowl	02, 25	48 ea	15.70/0.94
KL108 Δ	14 oz, 5.5" Nappie Bowl	02, 25	48 ea	11.90/0.75
KL119 Δ	12.5 oz, 5.5" Rimmed Nappie Bowl	02, 25	48 ea	14.65/0.78
KL924 Δ	12.5 oz, 5.5" Rimmed Nappie Bowl	92	48 ea	14.02/0.88
KL121 Δ	10 oz, 5.88" Grapefruit Bowl	02, 25	48 ea	12.50/0.51
KL118 Δ	10 oz, 5.13" Nappie Bowl	02, 03, 05, 25	48 ea	10.80/0.68
KL123 Δ	8 oz, 7.75" Wide Rimmed Salad Bowl	02	48 ea	19.00/0.92
KL800 Δ	5 oz, 5" Rimmed Fruit Bowl	02, 25, 70	48 ea	8.30/0.27
KL805 Δ	4.75 oz, 4.5" Rimmed Fruit Bowl	02, 03, 05, 25	48 ea	7.20/0.32
KL928 Δ	4.75 oz, 4.25" Rimmed Fruit Bowl	92	48 ea	7.15/0.31

NSF Listed products are designated with a Δ and may be prefixed with an N

Note: Melamine Dinnerware is not recommended for microwave

*Sandshades items vary in color, hue and intensity from piece to piece

DINNERWARE

Commercial Dinnerware

Polycarbonate material resists stains and chipping

- Designed for corrections, hospitals, schools, long term care facilities, or anywhere long product life and economy are important
- Super-tough polycarbonate dinnerware offers a five-year guarantee against breakage
- Plates have scratch-resistant textured surface
- Stacks with other polycarbonate dinnerware currently on the market
- Temperature use range: -40° to 212°F
- NSF Listed; dishwasher safe



Prod No	Description	Color	Pack	Cs Wt/Cube
<div style="display: flex; justify-content: space-around; font-size: small;"> White(02) Black(03) Teal(15) Tan(25) Dark Blue(50) Mauve(56) Slate(59) </div>				
Commercial Dinnerware Plates				
PCD210 ▲	10" Narrow Rim Plate	02, 03, 25, 50, 56, 59	48 ea	23.35/0.83
PCD209 ▲	9" Narrow Rim Plate	02, 03, 15, 25, 50, 56, 59	48 ea	17.20/0.58
PCD207 ▲	7.25" Narrow Rim Plate	25	48 ea	11.75/0.34
PCD206 ▲	6.5" Narrow Rim Plate	02, 03, 50, 56, 59	48 ea	10.00/0.36
PCD205 ▲	5.5" Narrow Rim Plate	02, 03	48 ea	6.50/0.23
Commercial Dinnerware Compartment Plates				
PCD211 ▲	11" Narrow Rim 3-Compartment Plate, 1.25" deep	03, 25	48 ea	26.69/0.89
PCD220 ▲	9" Narrow Rim 3-Compartment Plate, 1" deep	02, 59	48 ea	18.70/0.82
Commercial Dinnerware Oval Platter				
PCD412 ▲	12" x 9" Oval Platter	02, 03, 50	24 ea	11.30/0.40
Commercial Dinnerware Bowls & Cup				
PCD319 ▲	15 oz, 5.25" Nappie Bowl	02, 03, 25, 50	48 ea	10.99/0.61
PCD312 ▲	12 oz, 9" Soup Bowl	02, 03	48 ea	19.00/0.82
PCD310 ▲	10 oz, 4" Square Bowl	02	48 ea	6.24/0.46
PCD313 ▲	10 oz, 6" Rimmed Grapefruit Bowl	02, 59, 25	48 ea	11.60/0.56
PCD316 ▲	10 oz, 5" Nappie Bowl	03	48 ea	7.45/0.60
PCD308 ▲	8.4 oz, 4" Bouillon Cup	02, 15	48 ea	5.35/0.27
PCD305 ▲	5 oz, 3.5" Rimmed Fruit Bowl	02, 03, 15, 25, 50, 56, 59	48 ea	5.62/0.33
Commercial Dinnerware Mug				
PCD796 ▲	9.6 oz Mug	02, 25	48 ea	11.65/1.46

NSF Listed products are designated with a ▲ and may be prefixed with an N





Tulip Dishes

- Ideal for serving ice cream, puddings, salads, and more
- Stack with similar glass or plastic dessert dishes
- Made of break-resistant SAN
- 4532, 4534 are also available in extra-durable polycarbonate
- Tulip Dishes are the perfect compliment to the Coldmaster® Ice Cream Server shown below
- NSF Listed; dishwasher safe



Ice Cream Server & Lid

- Coldmaster technology and benefits (see pages 96-97)
- Accommodates standard 3-gallon ice cream tubs
- Free, clear polycarbonate lid included with each Coldmaster Ice Cream Server

NSF Listed products are designated with a **Δ** and may be prefixed with a **Repl** Replacement Lids (CM1013) also available



Ice Cream Shroud

- Attractive stainless steel cover offers an upscale appearance



Prod No	Description	Color	Pack	Cs Wt/Cube
Tulip Dishes				
4530 Δ	5 oz, 3.75" SAN Tulip Dessert Dish	03, 07, 42, 54, 55	24 ea	2.76/0.22
4532 Δ	5 oz, 3.75" PC Tulip Dessert Dish	07	24 ea	3.12/0.21
4531 Δ	5 oz, 4.63" SAN Tulip Berry Dish	03, 07, 42	24 ea	3.00/0.23
4535 Δ	8 oz, 4.63" SAN Tulip Berry Dish	07	48 ea	8.70/0.69
4533 Δ	13 oz, 5.5" SAN Tulip Bowl	07	24 ea	5.86/0.38
4534 Δ	13 oz, 5.5" PC Tulip Bowl	07	24 ea	5.86/0.38
Coldmaster Ice Cream Server, Lid & Shroud				
CM1012 Δ	3 gal Coldmaster Ice Cream Server	02, 03	1 ea	7.25/1.05
CM1013	Lid for Coldmaster Ice Cream Server	07	1 ea	1.50/0.68
38655	Coldmaster Ice Cream Shroud	—	1 ea	9.00/1.27

NSF Listed products are designated with a **Δ** and may be prefixed with an **N**



PLATES & BOWLS

Tough polycarbonate **Petal Mist**

provides heavy duty serving pieces with a design that looks great longer! Textured exterior hides scratches. Smooth interior makes it easy to clean.

Petal Mist®

- Perfect for buffets, food bars, delis, poolside, and catering
- Made of tough, break-resistant polycarbonate
- Textured exterior hides scratches; smooth interior is easy to clean
- Safe for use in freezers and in temperatures from 40° to 212°F
- See page 82 for additional Petal Mist trays and bowls
- NSF Listed; dishwasher safe



Leaf Plates

- Intricate leaf pattern enhances food appearance
- Molded of durable SAN for long life
- Dishwasher safe



Prod No	Description	Color	Pack	Cs Wt/Cube
Petal Mist Plates & Bowls				
6904 Δ	18 oz, 6" Petal Mist Bowl	03, 07	36 ea	7.31/0.53
6954 Δ	7.5" Petal Mist Plate	07	36 ea	10.35/0.47
6907 Δ	23.9 oz, 8" Petal Mist Soup/Salad Plate	07	36 ea	12.65/0.60
6956 Δ	9" Petal Mist Plate	07	36 ea	13.39/0.67
Leaf Plates				
0345	6" Leaf Plate	07	36 ea	13.50/0.73
0347	9" Leaf Plate	07	12 ea	8.56/0.57

NSF Listed products are designated with a **Δ** and may be prefixed with an N



Melamine Salad Bowls

- Made of dependable, impact-resistant melamine
- Safe for temperatures up to 212°F
- NSF Listed; dishwasher safe



Charger Plates

- Beautiful mirror-finish charger plates are an elegant addition to any place setting
- Easy care tarnish-resistant finish
- Hand wash only



Prod No	Description	Color	Pack	Cs Wt/Cube
Melamine Salad Bowls				
500B Δ	8 oz, 5.5" Melamine Salad Bowl	03	72 ea	11.02/0.45
575B Δ	13 oz, 6" Melamine Salad Bowl	03	72 ea	10.01/0.37
650B Δ	20 oz, 6.5" Melamine Salad Bowl	03	72 ea	21.02/0.96
800B Δ	24 oz, 7.5" Melamine Salad Bowl	03	48 ea	19.92/1.01
500M Δ	10 oz, 5.5" Melamine Salad Bowl	20	72 ea	11.09/0.45
575M Δ	10 oz, 6" Melamine Salad Bowl	20	72 ea	10.37/0.35
650M Δ	20 oz, 6.5" Melamine Salad Bowl	20	72 ea	21.02/0.96
800M Δ	27 oz, 7.5" Melamine Salad Bowl	20	48 ea	19.82/0.94
Charger Plates				
608924	12.25" Charger Plate, Chrome	-	12 ea	10.50/0.22

NSF Listed products are designated with a Δ and may be prefixed with an N

SERVING PIECES

Microwave-Ware

- Polycarbonate serving accessories designed specifically for microwave cooking
- Stays cool to the touch when coming out of the microwave
- Extremely impact resistant
- Small 8 oz Casserole is perfect for salads and sides—easily doubles as an olive, nut or butter dish on buffets
- Temperature use range: -40° to 212°F
- Dishwasher safe



Prod No	Description	Color	Pack	Cs Wt/Cube
Microwave-Ware				
7400 Δ	12 oz, 5.25" x 8.75" Oval Casserole	02	24 ea	9.79/0.44
7405 Δ	8 oz, 4.25" x 7.5" Oval Casserole Dish	02, 03	24 ea	24.00/0.40
7410	10 oz, 4" Jumbo Soup Mug	02	24 ea	10.63/0.89
7420	12 oz, 5.25" Handled Soup Bowl	02	24 ea	13.06/1.40

NSF Listed products are designated with a Δ and may be prefixed with an N



Electric Kettle

- Economical kettle includes 10.5 quart metal inset with hinged lid and ladle
- Thermostatically controlled warmer has low to high temperature settings
- 120 volt/450 watt; 6 foot detachable cord with 3-prong plug; insulating polypropylene shell
- Unit recommended for wet use
- NSF Listed; UL Listed



Soup Service

- Hefty, thick-walled designs keep food and beverages hot
- Stackable 12 oz Jumbo Soup/Latté Mug (4512) has polycarbonate inner liner and SAN exterior
- 8 and 12 oz handled bowls stack for storage; easy-grab handles are perfect for buffet lines

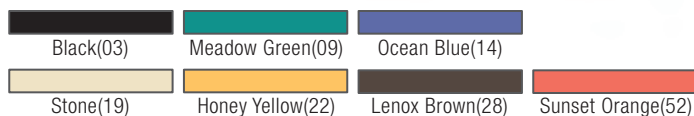

Prod No	Description	Color	Pack	Cs Wt/Cube
Electric Kettle				
0588 Δ	Electric Kettle with Inset, Lid & Ladle	03	1 ea	17.19/2.81
Soup Service				
7006	8 oz, 4.63" Handled Soup Bowl	09, 14, 19, 22, 28, 52	24 ea	7.80/0.53
7008	12 oz, 5.25" Handled Soup Bowl	19, 28	24 ea	11.64/1.40
4512	12 oz, 5.5" Jumbo Soup/Latté Mug with White Liner	19, 28	24 ea	14.16/1.00

NSF Listed products are designated with a Δ and may be prefixed with an N



PLATE COVERS

Polyglass Plate Covers

- Available to fit a wide variety of plate sizes and footprints
- Polyglass (PG) plate covers are designed for use in microwaves and heated carts
- Heat resistant to 270°F yet stays cool to the touch; excellent insulation properties
- Impact-resistant material offers a superior alternative to standard fiberglass covers
- NSF Listed; dishwasher safe



Polycarbonate Plate Covers

- Clear covers for easy viewing of food
- Highly heat- and break-resistant
- 1960 and 1992 also fit European “pin-fired” footless style plates for secure stacking
- Can be used in heated carts or under heat lamps up to 212°F
- Dishwasher safe



Prod No	Description	Color	Pack	Cs Wt/Cube
Polyglass Plate Covers				
91020 Δ	8.75" – 9.13" Polyglass Cover	202	12 ea	12.00/0.46
91040 Δ	9.5" – 10" Polyglass Cover	202	12 ea	12.00/0.62
91055 Δ	10.13" – 10.5" Polyglass Cover	202	12 ea	12.00/0.49
91070 Δ	10.25" – 10.63" Polyglass Cover	202	12 ea	12.00/0.49
91065 Δ	10.13" – 10.38" Polyglass Cover	202	12 ea	16.14/0.61
91080 Δ	10.5" – 10.75" Polyglass Cover	202, 203	12 ea	17.54/0.61
91075 Δ	10.63" – 10.69" Polyglass Cover	202	12 ea	16.89/0.61
91085 Δ	11" – 11.25" Polyglass Cover	202	12 ea	20.42/0.88
91090 Δ	11.75" – 12" Polyglass Cover	202	12 ea	21.59/0.88
91095 Δ	12" – 12.25" Polyglass Cover	202	12 ea	21.91/0.88
Polycarbonate Plate Covers				
1900	8.69" to 9.13" PC Cover	07	12 ea	6.20/0.86
1960	9" Combination "Pin-Fired" Plate & Bowl PC Cover	07	12 ea	9.00/1.05
1965	9.44" to 9.75" PC Cover	07	12 ea	7.70/0.86
1987	9.81" to 10" PC Cover	07	12 ea	7.20/0.86
1989	10.81" to 10.25" PC Cover	07	12 ea	10.30/0.82
1991 Δ	10.5" to 10.63" PC Cover	07	12 ea	10.10/1.14
1992 Δ	10.5" to 10.63" "Pin-Fired" PC Cover	07	12 ea	10.10/1.14
1993	10.75" to 11" PC Cover	07	12 ea	8.80/1.74
1994	12" PC Cover	07	12 ea	8.65/0.96

NSF Listed products are designated with a Δ and may be prefixed with an N



Custom Acrylic Plate Covers

- Excellent for keeping food warm
- Made to order for undersized or oversized plates and platters
- Use for table service or patient serving
- Dishwasher safe up to 180°F

CUSTOMIZE

Custom Plate Covers

Ordering information

- Minimum order – four dozen (48 ea)
- Two samples of each item are required for quote
- Please allow four to six (4-6) weeks for delivery of samples
- Custom plate cover orders require customer approval of samples prior to production
- If cover has not been previously molded, additional tooling charges apply
- A size variance of .13" is possible in the manufacturing of this product
- Larger and smaller sizes of custom covers by special quotation only
- Custom covers are not returnable



Note: Do not use Acrylic Plate Covers in heated carts, under heat lamps, or near exposed heat sources; safe for temperatures under 130°F

Translucent White(02) Clear(07)

Prod No	Description	Color	Pack	Cs Wt/Cube
Custom Acrylic Clear Round Plate Covers				
Group A	7" And Under Acrylic Round Cover	07	24 ea	10.00/0.79
Group B	7.06" – 8" Acrylic Round Cover	07	24 ea	12.00/0.79
Group C	8.06" – 10" Acrylic Round Cover	07	24 ea	16.00/1.73
Group D	10.06" – 14" Acrylic Round Cover	07	24 ea	21.00/2.93
Group E	14.06" – 16" Acrylic Round Cover	07	24 ea	23.00/3.78
Custom Acrylic Translucent Round Plate Covers				
Group AT	7" And Under Acrylic Round Cover	02	24 ea	10.00/0.79
Group BT	7.06" – 8" Acrylic Round Cover	02	24 ea	12.00/0.79
Group CT	8.06" – 10" Acrylic Round Cover	02	24 ea	16.00/1.27
Group DT	10.06" – 14" Acrylic Round Cover	02	24 ea	21.00/2.93
Group ET	14.06" – 16" Acrylic Round Cover	02	24 ea	23.00/2.37
Custom Acrylic Clear Oval Plate Covers				
Group P1	11" And Under Acrylic Oval Cover	07	24 ea	10.00/1.73
Group P2	11.06" – 12.5" Acrylic Oval Cover	07	24 ea	15.00/2.93
Group P3	12.56" – 14" Acrylic Oval Cover	07	24 ea	21.00/3.78
Group P4	14.06" – 16" Acrylic Oval Cover	07	24 ea	23.00/3.78
Custom Acrylic Translucent Oval Plate Covers				
Group P1T	11" And Under Acrylic Oval Cover	02	24 ea	10.00/0.79
Group P2T	11.06" – 12.5" Acrylic Oval Cover	02	24 ea	15.00/2.93
Group P3T	12.56" – 14" Acrylic Oval Cover	02	24 ea	21.00/2.68
Group P4T	14.06" – 16" Acrylic Oval Cover	02	24 ea	23.00/2.60

NSF Listed products are designated with a **Δ** and may be prefixed with an N



CARLISLE
FOODSERVICE PRODUCTS



CLASSIC
INVITING
ENDURING
BEAUTIFUL
EYE-CATCHING
DRINKWARE

Carlisle offers a complete line of barware, stemware, and serveware. Let us help you dress your bar and restaurant with our complete line of break-resistant beverage service products.



DRINKWARE

Astaire's **contemporary** design has the added bonus of **durable** polycarbonate. **Elegant** and break-resistant, it is perfect for everything from parties to poolside service.

Astaire Drinkware

- Sleek contemporary design is reminiscent of fine European crystal
- Stemless wine glass is the perfect choice for events that require additional stability
- Made of durable polycarbonate
- Excellent choice for outdoor and poolside events where breakage is a concern

NEW PRODUCT



RECOMMENDED GLASS RACK IS LISTED IN THE PRODUCT CHART



Clear(07)

Prod No	Description	Glass Rack	Color	Pack	Cs Wt/Cube
Astaire Stemware					
49500	6 oz Astaire Flute	RG36-4, RW30-3	07	12 ea	3.10/0.60
49501	11 oz Astaire Martini	RG9-3	07	12 ea	3.70/1.16
49502	13 oz Astaire White Wine	RG25-4, RW20-3	07	12 ea	3.60/0.87
49503	13 oz Astaire Stemless Wine	RG16-1	07	12 ea	2.30/0.45
49504	14 oz Astaire All Purpose	RG25-3, RW20-2	07	12 ea	3.70/0.66
49505	18 oz Astaire Iced Tea	RG25-3, RW20-2	07	12 ea	3.35/0.57
49506	22 oz Astaire Red Wine	RG9-4	07	12 ea	4.95/1.49





Alibi™ Barware

- Barware is light-weight yet durable SAN
- Great for outdoor & poolside use
- Has the look and feel of glass without the worry of breakage
- Custom decorating available; see page 324-325
- BPA free
- Dishwasher safe



Alibi™ Stemware

- Stemware is break-resistant made of polycarbonate
- Great for special occasion outdoor and pool service events
- Thick base & thin stem mimics traditional glassware
- Dishwasher safe



Clear(07)

Prod No	Description	Glass Rack	Color	Pack	Cs Wt/Cube
Alibi Drinkware & Stemware					
5601	1.5 oz Alibi Shot	RG49	07	24 ea	2.46/0.12
5602	2 oz Alibi Shooter	RG49	07	24 ea	1.64/0.09
5603	3 oz Alibi Shooter/Mini Dessert	RG49	07	24 ea	2.09/0.12
5609	9 oz Alibi Rocks/Juice	RG25-1	07	24 ea	5.60/0.48
5610	10 oz Alibi Hi-Ball	RG49-2	07	24 ea	6.50/0.58
5612	12 oz Alibi Double Old Fashioned	RW20	07	24 ea	7.92/0.62
5614	14 oz Alibi Beverage	RW30-1	07	24 ea	8.38/0.75
5616	16 oz Alibi Pint/Mixing	RW20-1	07	24 ea	10.50/0.56
5646	9 oz Alibi Martini	RG9-3	07	24 ea	4.64/0.94
5644	6 oz Alibi Champagne Flute	RW30-3	07	24 ea	5.10/1.20
5640	8 oz Alibi Champagne Flute	RE25-5	07	24 ea	3.75/1.46
5645	8 oz Alibi White Wine	RG16-4	07	24 ea	4.64/0.94
5643	11 oz Alibi White Wine	RW30-2	07	24 ea	4.20/1.50
5642	20 oz Alibi Red Wine	RG16-4	07	24 ea	5.87/2.20
5641	22 oz Alibi Balloon	RG16-4	07	24 ea	5.45/2.32
5647	12 oz Cocktail	RG25-4, RW20-3	07	24 ea	8.45/1.34
5648	15 oz Water	RG25-3, RW20-2	07	24 ea	8.00/1.37
5649	16 oz Pilsner	RG25-5, RW20-4	07	24 ea	12.74/1.70
5650	16 oz Hurricane	RG25-4, RW20-3	07	24 ea	9.20/1.57
5651	11 oz Margarita	RG9-3	07	24 ea	8.45/2.75
5652	16 oz Margarita, Grande	RG9-3	07	24 ea	15.90/3.65

SAN TUMBLERS

Carlisle leads the industry in **durable SAN Tumblers**. The variety of sizes, finishes, and decorating opportunities are sure to **satisfy all of your tumbler needs**.

Stackable

- Durable SAN reduces breakage
- Tapered sides make tumblers easy to stack
- Interior lugs prevent jamming when stored
- Textured exterior hides wear and tear
- Custom decorating available; see page 324-325
- BPA free
- Dishwasher safe

Note: Please specify case pack when ordering



RECOMMENDED GLASS RACK IS LISTED IN THE PRODUCT CHART



Prod No	Description	Disposable Lid	Glass Rack	Color	Pack	Cs Wt/Cube
SAN – Large Packs						
5501	5 oz SAN Stackable Tumbler	DX1193ST8714*	RG49-1	07, 10, 13, 47, 54	72 ea	6.80/0.52
5526	8 oz SAN Stackable Tumbler	DX1193ST8714*	RG49-1	07, 10, 13, 47, 54	72 ea	8.40/0.64
5529	9 oz Old Fashioned SAN Stackable Tumbler	DXTT58*	RG25-1	07, 10, 13	72 ea	11.35/0.85
5506	9.5 oz SAN Stackable Tumbler	5506L	RG49-1	07, 10, 13, 47, 54	72 ea	10.25/0.72
5212	12 oz SAN Stackable Tumbler	5212L	RG25-2	07, 10, 13, 47, 54	72 ea	12.45/0.95
5216	16 oz SAN Stackable Tumbler	DXTT58*	RG25-2	07, 10, 13, 47, 54	72 ea	15.40/1.12
5220	20 oz SAN Stackable Tumbler	DX30008714*	RW20-2	07, 10, 13, 47, 54	72 ea	17.55/1.34
5224	24 oz SAN Stackable Tumbler	DXTT45*	RG16-3	07, 10, 13	72 ea	20.10/1.51
5232	32 oz Tall SAN Stackable Tumbler	—	RG16-3	07, 10	24 ea	8.90/0.94
5532	32 oz SAN Stackable Tumbler	—	RG16-3	07, 10, 13	48 ea	16.55/1.74
43937	5.5 oz Low Profile SAN Stackable Tumbler	—	RW20	07	72 ea	6.34/0.38
SAN – Small Packs						
5501-2	5 oz SAN Stackable Tumbler	DX1193ST8714*	RG49-1	07	24 ea	2.25/0.18
5526-2	8 oz SAN Stackable Tumbler	—	RG49-1	07	24 ea	2.90/0.23
5529-2	9 oz Old Fashioned SAN Stackable Tumbler	DXTT58*	RG25-1	07	24 ea	3.85/0.29
5506-2	9.5 oz SAN Stackable Tumbler	5506L	RG49-1	07	24 ea	3.40/0.25
5212-2	12 oz SAN Stackable Tumbler	5212L	RG25-2	07	24 ea	4.00/0.33
5216-2	16 oz SAN Stackable Tumbler	DXTT58*	RG16-2	07	24 ea	5.25/0.40
5220-2	20 oz SAN Stackable Tumbler	DX30008714*	RW20-2	07	24 ea	6.20/0.45

Note: *The DX Series Disposable Lids listed above are available through our Dinox Catalog





Genuine Coca-Cola® & Pepsi® Stackable Tumblers

- Same features as our regular SAN Stackable Tumblers
- Printed with the famous Coca-Cola® or Pepsi® trademark
- BPA free

Items are Trademarked by the Coca-Cola® Company. Coca-Cola® Stackable Tumblers are available for distribution only to authorized Coca-Cola® fountain customers for commercial foodservice use. Coca-Cola® Stackable Tumblers cannot be used for retail sale to the public.

Items are Trademarked by Pepsico®. Pepsico® Stackable Tumblers are available for distribution only to authorized Pepsico® fountain customers for commercial foodservice use. Pepsico® Stackable Tumblers cannot be used for retail sale to the public.



Prod No	Description	Disposable Lid	Glass Rack	Pack	Cs Wt/Cube
Coca-Cola Stackable Tumblers					
52163550E	16 oz Coca-Cola Tumbler, Clear	DXTT58*	RG25-2	72 ea	15.40/1.12
52203550A	20 oz Coca-Cola Tumbler, Clear	DX30008714*	RW20-2	72 ea	17.55/1.34
52243550G	24 oz Coca-Cola Tumbler, Clear	DXTT45*	RG16-3	72 ea	20.30/2.14
5232-63550J	32 oz Coca-Cola Tumbler, Clear	—	RG16-3	72 ea	25.63/2.42
52163550D	16 oz Coca-Cola Tumbler, Ruby	DXTT58*	RG25-2	72 ea	15.70/1.33
52203550	20 oz Coca-Cola Tumbler, Ruby	DX30008714*	RW20-3	72 ea	17.55/1.34
52243550H	24 oz Coca-Cola Tumbler, Ruby	DXTT45*	RG16-3	72 ea	20.10/1.51
5232-63550I	32 oz Coca-Cola Tumbler, Ruby	—	RG16-3	72 ea	25.63/2.42
Pepsi Stackable Tumblers					
5216841C2	16 oz Pepsi Clear Script	DXTT58*	RG25-2	72 ea.	15.50/1.30
52163841A	16 oz Pepsi Ice Blue Script	DXTT58*	RG25-2	72 ea.	15.50/1.30
52163841F	16 oz Pepsi Royal Blue Script	DXTT58*	RG25-2	72 ea.	15.50/1.30
5216C203	16 oz Pepsi Clear Globe	DXTT58*	RG25-2	72 ea.	15.50/1.30
5216RB203	16 oz Pepsi Royal Blue Globe	DXTT58*	RG25-2	72 ea.	15.50/1.30
5216IB203	16 oz Pepsi Ice Blue Globe	DXTT58*	RG25-2	72 ea.	15.50/1.30
5220841C2	20 oz Pepsi Clear Script	DX30008714*	RW20-2	72 ea.	19.00/1.76
52203841B	20 oz Pepsi Ice Blue Script	DX30008714*	RW20-2	72 ea.	19.00/1.76
52203841G	20 oz Pepsi Royal Blue Script	DX30008714*	RW20-2	72 ea.	19.00/1.76
5220C203	20 oz Pepsi Clear Globe	DX30008714*	RW20-2	72 ea.	19.00/1.76
5220RB203	20 oz Pepsi Royal Blue Globe	DX30008714*	RW20-2	72 ea.	19.00/1.76
5220IB203	20 oz Pepsi Ice Blue Globe	DX30008714*	RW20-2	72 ea.	19.00/1.76
5224841C2	24 oz Pepsi Clear Script	DXTT45*	RG16-3	72 ea.	21.40/2.11
52243841C	24 oz Pepsi Ice Blue Script	DXTT45*	RG16-3	72 ea.	21.40/2.11
52243841H	24 oz Pepsi Royal Blue Script	DXTT45*	RG16-3	72 ea.	21.40/2.11
5224C203	24 oz Pepsi Clear Globe	DXTT45*	RG16-3	72 ea.	21.40/2.11
5224RB203	24 oz Pepsi Royal Blue Globe	DXTT45*	RG16-3	72 ea.	21.40/2.11
5224IB203	24 oz Pepsi Ice Blue Globe	DXTT45*	RG16-3	72 ea.	21.40/2.11
5232841C2	32 oz Pepsi Clear Script	—	RG16-3	24 ea.	8.90/1.17
52323841D	32 oz Pepsi Ice Blue Script	—	RG16-3	24 ea.	8.90/1.17
52323841I	32 oz Pepsi Royal Blue Script	—	RG16-3	24 ea.	8.90/1.17
5232C203	32 oz Pepsi Clear Globe	—	RG16-3	24 ea.	8.90/1.17
5232RB203	32 oz Pepsi Royal Blue Globe	—	RG16-3	24 ea.	8.90/1.17
5232IB243	32 oz Pepsi Ice Blue Globe	—	RG16-3	24 ea.	8.90/1.17

Note: *The DX Series Disposable Lids listed above are available through our Dinex Catalog



SAN TUMBLERS

Louis Tumblers are a **timeless shape in the history of beverage ware.** Ours is perfect for service where breakage is a concern. **Well balanced with the feel of heavy glass.**



RECOMMENDED GLASS RACK IS LISTED IN THE PRODUCT CHART



Louis™

- Faceted shape offers easy grip
- Appearance of glass
- Made of break-resistant SAN
- Stackable space saving feature
- Custom decorating available; see page 324-325
- BPA free
- NSF Listed; dishwasher safe



An attractive, classic workhorse tumbler collection. **Perfect for healthcare and hospitals.**

Lorraine™

- Attractive panel and facet design
- Made of break-resistant SAN
- 43649—9 oz Old Fashioned is designed for healthcare tray service, bar or room service
- 43647—6 oz size meets healthcare portion standards
- Stacking lugs prevent jamming
- BPA free
- Dishwasher safe



Clear(07)

Prod No	Description	Disposable Lid	Glass Rack	Color	Pack	Cs Wt/Cube
Louis SAN Tumblers						
5806 Δ	6 oz Louis Tumbler	DX11968714*	RG36-1	07	24 ea	3.12/0.24
5808 Δ	8 oz Louis Rocks	DX22259000*	RG36-1	07	24 ea	4.20/0.37
5810 Δ	10 oz Louis Tumbler	5810L	RG25-1	07	24 ea	5.07/0.43
5812 Δ	12 oz Louis Rocks	5812L	RG25-1	07	24 ea	5.40/0.47
5814 Δ	14 oz Louis Tumbler	DXTT501*	RG25-2	07	24 ea	5.66/0.47
5816 Δ	16 oz Louis Tumbler	DXTT58*	RG25-2	07	24 ea	6.90/0.58
5818 Δ	18 oz Louis Tumbler	DXTT58*	RW20-1	07	24 ea	6.46/0.56
5820 Δ	20 oz Louis Tumbler	—	RW20-1	07	24 ea	7.86/0.73
5822 Δ	22 oz Louis Tumbler	5822L	RW20-2	07	24 ea	8.19/0.76
5832 Δ	32 oz Louis Tumbler	—	RG16-3	07	24 ea	12.21/1.08
Lorraine SAN Tumblers						
43647	6 oz Lorraine Tumbler	—	RG36-1	07	24 ea	2.93/0.30
43648	8 oz Lorraine Tumbler	1110L	RW30	07	24 ea	3.24/0.30
43649	9 oz Lorraine Old Fashioned Tumbler	DXTT59*	RW20	07	24 ea	3.44/0.35
43651	12 oz Lorraine Tumbler	—	RG25-2	07	24 ea	4.38/0.44
43653	16 oz Lorraine Tumbler	DX30008714*	RW20-1	07	24 ea	5.02/0.53
43655	22 oz Lorraine Tumbler	—	RG16-2	07	24 ea	6.04/0.50

NSF Listed products are designated with a Δ and may be prefixed with an N

Note: *The DX Series Disposable Lids listed above are available through the Carlisle | Dinox Catalog



Inspired by a long cherished French bar ware design, **Bistro is an agile design that you can employ in high end restaurants and small town diners alike.** Bistro never goes out of style.

Bistro™

- Attractive traditional fluted exterior
- Interior lugs prevent jamming when stored
- Made of break-resistant SAN
- BPA free
- Dishwasher safe



The perfect stacking tumbler to use in healthcare and other **situations where a better grip is helpful.**

Crystalon® Stack-All®

- Stylish, ribbed texture offers better grip
- Made of break-resistant SAN
- Stacking lugs prevent jamming when stored
- BPA free
- Dishwasher safe

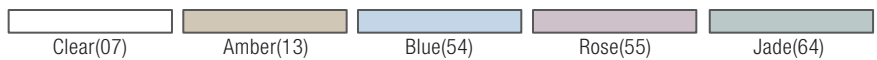

Prod No	Description	Disposable Lid	Glass Rack	Color	Pack	Cs Wt/Cube
Bistro SAN Tumblers						
1104	4 oz Bistro Tumbler	—	RG49-1	07	144 ea	8.64/0.61
1105	5 oz Bistro Tumbler	DX11928714*	RG36-1	07	144 ea	10.08/0.84
1108	8 oz Bistro Tumbler	—	RW30	07	72 ea	8.14/0.78
1110	10 oz Bistro Tumbler	1110L	RW30	07	72 ea	7.90/0.73
1112	12 oz Bistro Tumbler	1112L	RW30-1	07	72 ea	9.50/0.73
1116	16 oz Bistro Tumbler	—	RG25-2	07	72 ea	11.74/1.01
0120	20 oz Bistro Tumbler	DX21259000*	RW20-2	07	72 ea	14.25/1.33
0132	32 oz Bistro Tumbler	—	RG9-3	07	48 ea	14.25/1.53
Crystalon SAN Stack-All Tumblers						
4008	8 oz Crystalon SAN Tumbler	DX1198ST8714*	RW30	07, 55	48 ea	7.06/0.47
4029	9 oz Old Fashioned Crystalon SAN Tumbler	DX21259000*	RW20	07, 13, 55, 64	48 ea	7.00/0.62
4010	9.5 oz Crystalon SAN Tumbler	43635L	RW30	07, 54	48 ea	7.58/0.53
4012	12 oz Crystalon SAN Tumbler	5212L	RG25-2	07, 13, 54, 55, 64	48 ea	8.88/0.61
4016	16 oz Crystalon SAN Tumbler	DXTT58*	RW20-1	07, 13, 54, 55, 64	48 ea	11.90/0.72
4020	20 oz Crystalon SAN Tumbler	—	RW20-1	07, 13, 54, 55, 64	48 ea	12.50/0.90

Note: *The DX Series Disposable Lids listed above are available through the Carlisle | Dinex Catalog



SAN TUMBLERS

Genuine Coca-Cola® Tumbler

- Classic shape with the appearance of glass
- Dishwasher safe; stackable
- Available in clear with Coca-Cola® logo
- Made of break-resistant, BPA free SAN

These items are Trademarked by the Coca-Cola® Company. Coca-Cola® Stackable Tumblers are available for distribution only to authorized Coca-Cola® fountain customers for commercial foodservice use. Coca-Cola® Stackable Tumblers cannot be used for retail sale to the public.



439945200

The tried and true diner tumblers continue to delight customers around the world.

Pebble Optic™

- Attractive pebbled exterior hides scratches
- Thick-walled SAN construction offers sturdy feel
- 5 oz, 8 oz, 9.5 oz, and 12 oz sizes have stacking feature on bottom
- BPA free
- Dishwasher safe



Prod No	Description	Disposable Lid	Glass Rack	Color	Pack	Cs Wt/Cube
Genuine Coca-Cola Tumbler						
439945200	24 oz Coca-Cola Tumbler with Logo		RW20-2	—	72 ea	22.00/2.56
Pebble Optic Tumblers						
5505	5 oz Pebble Optic Tumbler	DX24019000*	RG36-1	07	24 ea	3.70/0.49
5508	8 oz Pebble Optic Tumbler	—	RG36-1	07	24 ea	4.75/0.49
5509	9.5 oz Pebble Optic Tumbler	—	RW30	07, 10, 18	24 ea	5.76/0.78
5512	12 oz Pebble Optic Tumbler	DX1198ST8714*	RG36-2	07, 18	24 ea	6.65/0.78
5517	16 oz Pebble Optic Tumbler	—	RG25-2	07, 10, 18	24 ea	7.00/1.03
5519	20 oz Pebble Optic Tumbler	DX11948714	RG25-3	07	24 ea	8.85/1.02

Note: *The DX Series Disposable Lids listed above are available through our Dinx Catalog

POLYCARBONATE TUMBLERS

Soon becoming our classic barware line. Trusted by pool management to **delight customers without the worry of breakage.**

Liberty™

- Serve poolside drinks without the breakage worries of glass
- Liberty polycarbonate eliminates the need to sacrifice your presentation with disposables
- Custom decorating available; see page 324-325
- Dishwasher safe



Clear(07)

Prod No	Description	Glass Rack	Color	Pack	Cs Wt/Cube
Liberty Drinkware					
43628	8 oz Liberty Old Fashioned	RW30	07	24 ea	7.06/0.47
43625	18 oz Liberty Double Old Fashioned	RW20-1	07	24 ea	7.20/1.25
43626	22 oz Liberty Hi-Ball	RW20-2	07	24 ea	8.25/1.82
43623	15 oz Liberty Pilsner	RW20-3	07	24 ea	9.40/2.98
43624	9.5 oz Liberty Margarita	RG9-2	07	24 ea	8.20/1.38
43627	8 oz Liberty Martini	RG9-2	07	24 ea	6.55/1.90
43629	9 oz Liberty Cocktail	RG25-2	07	24 ea	8.20/1.38
43620	5 oz Liberty Champagne Flute	RG25-4	07	24 ea	8.20/2.25
43631	15 oz Liberty Hurricane	RG25-4	07	24 ea	7.28/1.31
43630	13 oz Liberty Cocktail	RG25-3	07	24 ea	9.40/2.98
43621	10.5 oz Liberty White Wine	RW20-2	07	24 ea	7.70/1.79
43622	13.5 oz Liberty Goblet	RG16-3	07	24 ea	7.90/1.79



POLYCARBONATE TUMBLERS

A **fun color grouping** that is a perfect look for poolside or barbeques where breakage is a concern.

Crystalon® RimGlow™

- Tumblers change hue and intensity with variations in lighting, perspective, and beverage color
- Mix and match colors in brilliant, long-lasting polycarbonate
- Coordinates with Caribbean color dinnerware shown in the Dinnerware section of this catalog
- Dishwasher safe

4035



Stackable

- Ideal for prisons, schools, and high-volume chains
- Extremely break-resistant polycarbonate extends tumbler life
- Dishwasher safe



RECOMMENDED GLASS RACK IS LISTED IN THE PRODUCT CHART



Prod No	Description	Disposable Lid	Glass Rack	Color	Pack	Cs Wt/Cube
Crystalon Polycarbonate RimGlow Tumblers						
4033	12 oz Crystalon PC Tumbler	5212L	RG25-2	09, 14, 22, 52	48 ea	9.20/0.60
4034	16 oz Crystalon PC Tumbler	DXTT58*	RW20-1	07, 09, 14, 22, 52	48 ea	11.90/0.72
4035	20 oz Crystalon PC Tumbler	—	RW20-1	09, 14, 22, 52	48 ea	12.50/0.90
Polycarbonate Stackable Tumblers						
5105-2	5 oz PC Stackable Tumbler	DX1193ST8714*	RG49-1	07	24 ea	2.50/0.20
5108-2	8 oz PC Stackable Tumbler	—	RG49-1	07	24 ea	3.00/0.25
5109-2	9.5 oz PC Stackable Tumbler	5109L	RG49-1	07	24 ea	3.55/0.25
5112-2	12.5 oz PC Stackable Tumbler	DXTT50*	RW30-1	07	24 ea	4.25/0.46
5116-2	16.5 oz PC Stackable Tumbler	DX22259000*	RG25-2	07, 10	24 ea	4.85/0.40
5120	20 oz PC Stackable Tumbler	DX30008714*	RW20-2	07	24 ea	6.30/0.48

Note: *The DX Series Disposable Lids listed above are available through the Carlisle | Dinx Catalog



Swirl

- Unique swirl design creates a perfect, glass-like tabletop beverage presentation
- Dishwasher safe



Another perfect design from the masters at Carlisle. **Six sizes available for all of your bar needs.**

Lafayette®

- Distinctive fluted pattern has the look and style of glass
- Perfect for bar service, room service, or catered events
- Stacking lugs prevent jamming
- Slotted base allows complete draining
- Dishwasher safe



Clear(07)

Prod No	Description	Disposable Lid	Glass Rack	Color	Pack	Cs Wt/Cube
Swirl Polycarbonate Tumblers						
43662	5 oz Swirl PC Tumbler	—	RG36-1	07	36 ea	4.06/0.23
43663	8 oz Swirl PC Tumbler	DX20029000*	RG36-1	07	36 ea	5.15/0.41
43664	9 oz Swirl PC Tumbler	—	RG25-1	07	36 ea	4.77/0.44
43665	10 oz Swirl PC Tumbler	—	RW30-1	07	36 ea	6.20/0.50
43666	12 oz Swirl PC Tumbler	—	RG25-2	07	36 ea	7.63/0.67
43668	16 oz Swirl PC Tumbler	—	RW20-1	07	36 ea	7.52/0.61
43674	22 oz Swirl PC Tumbler	—	RW20-2	07	36 ea	10.96/0.89
Lafayette Polycarbonate Tumblers						
43633	8 oz Lafayette PC Tumbler	DX20029000*	RG36-1	07	36 ea	5.70/0.30
43635	10 oz Lafayette PC Tumbler	43635L	RW30-1	07	36 ea	5.34/0.38
43636	12 oz Lafayette PC Tumbler	43636L	RG25-2	07	36 ea	7.60/0.38
43637	12 oz Lafayette PC Old Fashioned Tumbler	DX21259000*	RW20	07	36 ea	7.10/0.42
43638	16 oz Lafayette PC Tumbler	DX21259000*	RW20-1	07	36 ea	7.59/0.52
43640	22 oz Lafayette PC Tumbler	—	RW20-2	07	36 ea	9.07/0.69

Note: *The DX Series Disposable Lids listed above are available through the Carlisle | Dinex Catalog

CARAFES & MUGS

Stylish design makes **Cascata** Carafes the most **attractive** carafe you can choose for tabletops and buffets, while offering **convenience** and superior **functionality**.

Cascata Carafe

- Ergonomic shape is easy to hold and angled rim provides a drip-free pour
- Larger sizes can be used for water, juice or wine
- Smaller sizes are good for salad dressings, syrups, single-portion drinks, and snack mix
- A green alternative to single-serve drinks
- Snap-on lids available in solid or hinged styles and fit .5, 1 and 1.5 Liter Carafes
- All sizes have capacity marks for portion control
- Durable polycarbonate looks like glass
- Dishwasher safe
- NSF Listed



Snap-on lids available in solid or hinged styles

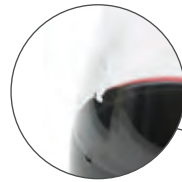

All sizes have capacity marks for portion control



RECOMMENDED GLASS RACK IS LISTED IN THE PRODUCT CHART



2 Cup Carafe

- Durable SAN 11 oz capacity carafe is perfect for room service, hospitals, nursing homes, restaurants, and cafeterias
- Ribbed neck and textured finish provide a better grip and greater safety than glass bottles
- BPA free
- Dishwasher safe



Prod No	Description	Capacity Marks	Glass Rack	Color	Pack	Cs Wt/Cube
Cascata Carafes & Lids						
70900 Δ	0.25 Liter Carafe	6 oz, 8 oz, 0.25L	RW30-1	07	12 ea	2.35/0.45
70901 Δ	0.50 Liter Carafe	0.5L	RW20-2	07	12 ea	4.40/0.80
70902 Δ	1 Liter Carafe	1.0L	RG16-5	07	12 ea	5.40/1.32
70903 Δ	1.5 Liter Carafe	1.5L	RG9-5	07	12 ea	6.85/1.97
70904 Δ	Flat Carafe Lid (fits 70901, 70902, 70903)	—	—	02	12 ea	0.50/0.05
70905 Δ	Hinged Carafe Lid (fits 70901, 70902, 70903)	—	—	02	12 ea	0.50/0.05
2 Cup Carafe						
7000	11 oz Carafe	DX55-57*	RG16-2	07	36 ea	9.22/1.91

NSF Listed products are designated with a Δ and may be prefixed with an N

Note: *The DX Series Disposable Lids listed above are available through the Carlisle | Dinox Catalog



Lexington™ Polycarbonate Mug

- Heavy-weight mug offers traditional styling in durable polycarbonate
- Crystal clear mug has the look and feel of glass without the replacement
- Recessed drain for easy drying
- Dishwasher safe



43965

Carlisle Mugs

- Made of break-resistant, BPA free Tritan
- Specially designed, large handle allows for easy holding, keeps fingers away from hot liquids
- Available in 6 colors to coordinate with Carlisle's existing dinnerware lines
- Safe for temperatures up to 190°F (88°C)
- Custom decorating available; see page 324-325
- Dishwasher safe
- NSF Listed



43068

43066



Coffee Mugs

- Rugged, chip- and crack-resistant plastic to give you long-wearing service
- Diablo and Rustic mugs have double-wall construction to maintain hot temperatures longer
- Diablo II has single-wall construction for money-saving service
- All mugs are dishwasher safe



8004

8505

8104

4512

Customized mugs help promote your company or services. See pages 324-325

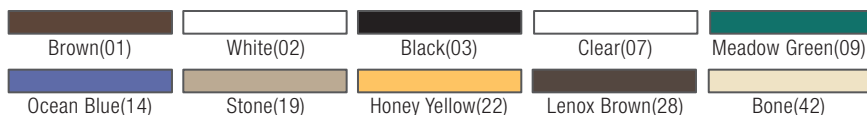

Prod No	Description	Disposable Lid	Glass Rack	Color	Pack	Cs Wt/Cube
Lexington Polycarbonate Mug						
43965	16 oz Lexington Mug	43965L	RG9-2	07	12 ea	10.00/0.66
Carlisle Mugs						
43066 Δ	8 oz Carlisle Mug	5109L	RG16-1	02, 03, 09, 14, 22, 42	12 ea	16.30/1.47
43068 Δ	12 oz Carlisle Mug	—	RG16-1	02, 03, 09, 14, 22, 42	12 ea	5.22/0.53
Coffee Mugs						
8004	8 oz, 4.13" Diablo Mug with White Liner	—	RG9-1	01, 02	36 ea	15.66/1.18
8104	8 oz, 4.13" Diablo II Mug	—	RG9-1	01	36 ea	9.86/1.18
8505	8 oz, 4.25" Rustic Mug	—	RG9-1	19	36 ea	18.86/1.18
4512	12 oz, 5.5" Jumbo Soup/Latté Mug	—	RTP	19, 28	24 ea	14.16/1.00

NSF Listed products are designated with a Δ and may be prefixed with an N

Note: *The DX Series Disposable Lids listed above are available through the Carlisle | Dinex Catalog



PITCHERS

Carlisle offers the perfect selection of break-resistant pitchers. **They are an industry favorite.**

VersaPour® Polycarbonate Pitchers

- Lip design allows for easy pouring with ice from front or either side without splashing
- Sure grip ergonomic handle and thumb grip help control pouring
- Made of break-resistant polycarbonate for ultimate durability
- Thinner wall provides optimum strength and durability; reduces wait staff's wrist stress
- 5544 Window Pitcher provides a smooth surface for printing your logo; accommodates up to 2.88" wide by 2" tall image
- Custom decorating available; see page 324-325
- NSF Listed; dishwasher safe



VersaPour's specially contoured lip design allows for easy pouring with ice from front or sides without splashing



Polycarbonate Pitchers

- Ice trap retains ice or beer foam
- Made of break-resistant polycarbonate for ultimate durability
- NSF Listed; dishwasher safe



Prod No	Description	Glass Rack	Color	Pack	Cs Wt/Cube
VersaPour Polycarbonate Pitchers					
5540 Δ	60 oz VersaPour Pitcher	RF	07, 13	6 ea	4.40/0.88
5544 Δ	60 oz VersaPour Window Pitcher	RF	07	6 ea	4.40/1.23
Polycarbonate Pitchers					
5536 Δ	32 oz Polycarbonate Pitcher	RF	07	6 ea	3.65/0.44
5538 Δ	48 oz Polycarbonate Pitcher	RF	07	6 ea	4.43/1.00

NSF Listed products are designated with a Δ and may be prefixed with an N



Crystalite® Polycarbonate Pitchers

- Tapered lip permits controlled pouring of the beverage and ice
- Secure thumb hold on handle aids control of pitcher while pouring
- Slot at skirt base deters water collection
- Made of break-resistant polycarbonate for ultimate durability
- NSF Listed; dishwasher safe



Élan™ Polycarbonate Pitcher

- Thick walls and optic bottom gives these pitchers the look of glass
- Made of break-resistant polycarbonate
- Lid available separately
- Dishwasher safe



Stainless Steel Pitchers

- The look of silver, with the durability of stainless steel
- 18-8 stainless steel with mirror-polished finish
- Contoured lip to help control flow and prevent drips
- Hollow tubular handle
- Handwashing recommended



Clear(07)

Prod No	Description	Glass Rack	Color	Pack	Cs Wt/Cube
Crystalite Polycarbonate Pitchers					
5583 Δ	48 oz Crystalite Pitcher	RF	07	6 ea	6.05/0.99
5587 Δ	60 oz Crystalite Pitcher	RF	07	6 ea	6.94/1.22
Élan Polycarbonate Pitcher & Lid					
5570	58 oz Élan Pitcher	RF	07	6 ea	11.35/1.31
5573	Clear Lid for Élan Pitcher	—	07	6 ea	1.50/0.14
Stainless Steel Pitchers					
609270	2 qt Stainless Steel Bell Pitcher	—	—	1 ea	2.00/0.22
609273	3 qt Stainless Steel Bell Pitcher	—	—	1 ea	3.00/0.38

NSF Listed products are designated with a Δ and may be prefixed with an N



DISPOSABLE LIDS

Lids

- Carlisle Disposable Lids are a green solution that saves you money
- Lower your disposable costs when you replace your disposable kid's cups with reusable Carlisle Tumblers and Disposable Lids
- Snug fitting lids fit a variety of Carlisle Tumblers and are slotted for use with straws
- Use for room service applications or anywhere you want to avoid spills
- Lids are packed 1,000 per case



43636L with
4010



In addition to the disposable lids listed here, Carlisle | Dinex offers a large selection of disposable lids for Carlisle and non-Carlisle tumblers. See our Dinex catalog for a complete listing, or contact your local Dinex sales representative for more information.



5812L with 5812



1110L with 1110



1110L with 43648



5506L with 5506



43635L with 43635

Translucent(30)

Prod No	Description	Color	Pack	Cs Wt/Cube
Disposable Lids				
5810L	Fits 10 oz Louis Tumbler 5810	30	1 cs	4.05/0.84
5812L	Fits 12 oz Louis Tumbler 5812	30	1 cs	5.00/1.19
5822L	Fits 22 oz Louis Tumbler 5822	30	1 cs	6.12/1.68
5212L	Fits 12 oz Stackable Tumbler 5212, 12 oz Crystalon SAN Tumbler 4012, and 12 oz Crystalon PC Tumbler 4033	30	1 cs	7.42/0.46
5109L	Fits 9.5 oz Stackable PC Tumbler 5109, 8 oz Carlisle Mug 43066	30	1 cs	3.21/0.91
5506L	Fits 9.5 oz Stackable Tumbler 5506	30	1 cs	3.75/0.84
43635L	Fits 10 oz Lafayette Tumbler 43635 and 9.5 oz Crystalon SAN Tumbler 4010	30	1 cs	3.75/0.84
43636L	Fits 12 oz Lafayette Tumbler 43636	30	1 cs	4.05/0.84
1112L	Fits 12 oz Bistro Tumbler 1112	30	1 cs	3.75/0.84
1110L	Fits 10 oz Bistro Tumbler 1110 and 8 oz Lorraine Tumbler 43648	30	1 cs	4.05/0.84
63910L	Fits 10 oz Cambro® Tumbler NT10	30	1 cs	3.75/0.84
63912L	Fits 12 oz Cambro® Tumbler NT12	30	1 cs	7.42/0.46
52412L	Fits 12 oz Cambro® Tumbler LT12	30	1 cs	7.42/0.46

*Cambro® is a registered trademark of Cambro® Manufacturing Company
 **Carlisle is not associated in any way with Cambro® Manufacturing Company



CARLISLE
FOODSERVICE PRODUCTS

PRACTICAL
RUGGED
STYLISH
UNIQUE
**TABLETOP
ACCESSORIES**



*Set the mood with your tabletop accessories.
Carlisle offers a versatile range of accessories to
complete your tabletop setting in style.*





RAMEKINS

Carlisle has a ramekin for every application. All ramekins are offered in **high-quality melamine** that is dishwasher safe for years to come. **The perfect addition to your hardworking tableware.**

Straight Sided Ramekins

- Melamine ramekins are safe for temperatures up to 212°F
- A modern take on a traditional product
- Use for sauces, condiments, and mini desserts
- Ramekins stack for easy storage and space savings
- NSF Listed; dishwasher safe



Oval Ramekins

- Heavy-weight melamine ramekins are perfect for sauces, condiments, finger foods, mini desserts, etc.
- Oval shape is great for pouring dressings and sauces
- Wide design makes dipping easier
- NSF Listed; dishwasher safe



Square Melamine Ramekins

- Made of sturdy, break-resistant melamine
- 2 oz square ramekins available in single and double sizes
- Ramekins are stackable and can be used as a set for a variety of dipping sauces or individually for soy sauce and other condiments
- Safe for temperatures up to 212°F
- NSF Listed; dishwasher safe



Prod No	Description	Color	Pack	Cs Wt/Cube
Straight Sided Ramekins				
410 Δ	2 oz Straight Sided Ramekin	02, 03, 42	48 ea	8.49/0.37
412 Δ	3 oz Straight Sided Ramekin	02, 03, 42	48 ea	11.13/0.56
414 Δ	4 oz Straight Sided Ramekin	02, 03, 42	48 ea	11.97/0.64
Oval Ramekins				
S310 Δ	2 oz Oval Ramekin	02, 03, 42	48 ea	1.72/0.19
S312 Δ	3 oz Oval Ramekin	02, 03, 42	48 ea	4.63/0.14
S314 Δ	4 oz Oval Ramekin	02, 03, 42	48 ea	5.29/0.17
Square Melamine Ramekins				
0860 Δ	2 oz Square Ramekin	02, 03	48 ea	4.80/0.09
0862 Δ	Double 2 oz Square Ramekin	02, 03	24 ea	5.06/0.16

NSF Listed products are designated with a Δ and may be prefixed with an N



Japanese Style Ramekin

- Made of sturdy, break-resistant melamine
- 2 oz ramekins are styled with an Asian flare
- Heavy-weight design has the look and feel of ceramic or glass
- Ramekins are stackable and can be used for wasabi, ginger, or a variety of dipping sauces
- Safe for temperatures up to 212°F
- NSF Listed; dishwasher safe



Scalloped Melamine Ramekins

- Made of thick-walled, heavy-weight melamine
- Stylish design coordinates with our dinnerware and display pieces
- Serves sauces, butter, salad dressings, salsa, etc.
- NSF Listed; dishwasher safe



Melamine Butter Dish

- Ideal for small portions of butter, wasabi, or other condiments
- Wide mouth gives the illusion of a larger portion
- Heavy-weight sides have the look and feel of ceramic or glass
- Unique look is perfect for both casual and upscale dining or even pre-portioning in buffet and catering applications
- NSF Listed; dishwasher safe



Prod No	Description	Color	Pack	Cs Wt/Cube
Japanese Style Ramekin				
0864 Δ	2 oz Japanese Style Ramekin	02, 03	48 ea	8.16/0.02
Scalloped Ramekins				
43942 Δ	1 oz Scalloped Ramekin	02, 03, 42	48 ea	6.55/0.23
43943 Δ	2 oz Scalloped Ramekin	02, 03, 42	48 ea	8.08/0.31
43944 Δ	3 oz Scalloped Ramekin	02, 03, 42	48 ea	8.18/0.32
Melamine Butter Dish				
0855 Δ	1 oz Melamine Butter Dish	02	48 ea	5.52/0.18

NSF Listed products are designated with a Δ and may be prefixed with an N

RAMEKINS

Melamine Ramekins

- Thick-walled, heavy-weight melamine is perfect for serving sauces, butter, salad dressing, salsa, etc.
- NSF Listed; dishwasher safe



Salsa Dishes

- Carlisle salsa dishes are available in a variety of sizes, weights, and materials
- Designed to accommodate dipping large chips or appetizers
- Deep salsa bowl has 8 oz capacity, perfect for serving salsa, cheese sauce, soups, and other sauces



White(02)	Black(03)	Meadow Green(09)	Blue(14)	Honey Yellow(22)	Lenox Brown(28)
Bone(42)	Sunset Orange(52)	Roma Red(58)	Cobalt Blue(60)	Chocolate(69)	

Prod No	Description	Color	Pack	Cs Wt/Cube
Melamine Ramekins				
S277 Δ	1.75 oz Smooth Ramekin	42	48 ea	4.75/0.24
S275 Δ	1.5 oz Smooth Ramekin	02, 03, 09, 14, 22, 42, 52, 60	48 ea	5.15/0.26
0852 Δ	2 oz Smooth Ramekin	02, 03, 09, 14, 22, 42, 52, 58, 60, 69,	72 ea	10.50/0.35
S280 Δ	3 oz Smooth Ramekin	02, 03, 42, 52, 58, 60, 69	48 ea	8.60/0.35
S285 Δ	4 oz Smooth Ramekin	02, 03, 09, 14, 22, 42, 52, 58, 60,	48 ea	9.75/0.39
S286 Δ	6 oz Smooth Ramekin	02, 03, 42, 60, 69	48 ea	12.65/0.50
S279 Δ	2 oz Fluted Ramekin	02, 03, 42, 60, 69	48 ea	7.00/0.33
S282 Δ	3 oz Fluted Ramekin	02, 03, 42, 60, 69	48 ea	8.60/0.35
S287 Δ	4 oz Fluted Ramekin	02, 03, 42, 60, 69	48 ea	9.70/0.43
Salsa Dishes				
0873 Δ	3 oz Melamine Molcajete Ramekin	03	48 ea	8.67/0.32
0878 Δ	8 oz Melamine Molcajete Ramekin	03	48 ea	10.15/0.50
43125	5 oz SAN Salsa Dish	60	48 ea	6.14/0.32
4553	8 oz Melamine Deep Salsa Bowl	28	36 ea	8.07/0.85
0875 Δ	5 oz Melamine Salsa Dish	02, 03, 42, 60	48 ea	10.70/0.36

NSF Listed products are designated with a Δ and may be prefixed with an N





Ramekins & Sauce Cups

- Perfect for individual service of butter, salsa, condiments, sauce
- Made of durable, break-resistant SAN
- Available in four distinct styles
- 0362, 0843, 0844, 0845, 2500: NSF Listed; dishwasher safe



Stainless Steel Ramekin & Sauce Cup

- Rust-free, 18-8 stainless provides durable, easy care service
- Dishwasher safe



SAN Ramekins

- Economical SAN ramekins serve sauces, butter, salad dressings, salsa, etc.
- Stackable design for easier storage
- Dishwasher safe



Prod No	Description	Color	Pack	Cs Wt/Cube
Ramekins & Sauce Cups				
0362 Δ	2.5 oz Standard Ramekin	02, 07, 28	48 ea	4.35/0.36
0843 Δ	1 oz Fluted Ramekin	02	48 ea	2.10/0.17
0844 Δ	2 oz Fluted Ramekin	02, 07	48 ea	3.05/0.30
0845 Δ	4.5 oz Fluted Ramekin	02, 07, 28	48 ea	5.30/0.59
2500 Δ	2.5 oz SAN Sauce Cup	07	72 ea	3.35/0.50
0820	2.75 oz Oyster Sauce Cup	07	144 ea	7.50/1.40
0338	2 oz Sea Shell Sauce Cup	02	48 ea	4.20/0.35
0830	1 oz Soufflé Cup	07	144 ea	5.65/0.58
0831	2.5 oz Soufflé Cup	07	144 ea	12.10/1.29
602400	1.5 oz Stainless Steel Classic Ramekin	—	144 ea	6.50/0.40
602500	2.5 oz Stainless Steel Classic Sauce Cup	—	144 ea	8.10/0.38
SAN Ramekins				
43121	1.5 oz Smooth Ramekin	42	48 ea	3.00/0.29
43122	2 oz Smooth Ramekin	03	48 ea	3.50/0.22
43123	3 oz Smooth Ramekin	03, 42	48 ea	4.00/0.24
43126	6 oz Smooth Ramekin	03, 42, 60	48 ea	6.41/0.38

NSF Listed products are designated with a Δ and may be prefixed with an N

COFFEE SERVICE

Sugar Caddies

- Merchandiser caddy has pockets for salt and pepper shakers plus sign clip
- NSF Listed; dishwasher safe



Creamer/Pitchers

- Stain-resistant creamers and pitchers can be used for syrup, cream, salad dressings, sauces, etc
- Easy-pour, no-drip lip design
- Made of dishwasher safe SAN; safe for temperatures from 0° to 180°F
- 4560 is NSF Listed



Cheese Shaker/Sugar Pourer

- Popular 12 oz size is made of durable, break-resistant SAN
- Threaded lip fits standard shaker or pourer caps

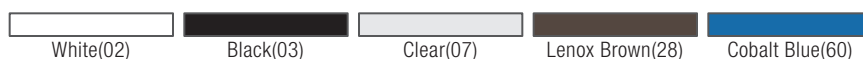

Prod No	Description	Color	Pack	Cs Wt/Cube
Caddies, Pitchers & Pourers				
4549 Δ	Crystalite Caddy (holds 20 packets)	07	24 ea	4.20/0.36
4550 Δ	Standard Caddy (holds 20 packets)	02, 03, 07, 28, 60	24 ea	5.26/0.37
4551 Δ	Merchandiser Caddy (holds 50 packets)	03, 28	24 ea	8.51/0.76
4552 Δ	Three Compartment Caddy (holds 50 packets)	02	24 ea	5.11/0.36
4560 Δ	2 oz Syrup Pitcher/Creamer	02, 07	36 ea	4.86/0.32
4563	3 oz Creamer/Pitcher	02	36 ea	6.89/0.48
3312	12 oz Base Only	07	72 ea	12.82/1.28
3316	Base with Pourer Top	07	36 ea	8.24/0.71
3319	Base with Shaker Top	07	36 ea	8.24/0.71

NSF Listed products are designated with a Δ and may be prefixed with an N





Rhapsody™ Gravy Boats

- Perfectly balanced handle is securely welded to the base to easily pour gravies, sauces, or dressings
- Tapered spout helps prevent dripping
- Made of easy to care for, tarnish-resistant 18-8 stainless steel



J-Jars

- Durable jars are ideal for condiments of all types: jelly, jam, mustard, sauces, etc.
- Chrome-plated caddy offers beauty and strength
- NSF Listed



Bud Vases

- Let flowers add the finishing touch to any tabletop
- Beautiful, break-resistant acrylic with heavy base to prevent messy spills

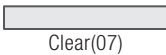

Prod No	Description	Color	Pack	Cs Wt/Cube
Gravy Boats				
609111	3 oz Gravy Boat	—	24 ea	5.00/0.35
609112	5 oz Gravy Boat	—	12 ea	4.00/0.29
609113	8 oz Gravy Boat	—	10 ea	5.00/0.37
J-Jars				
4571 Δ	8 oz J-Jar only	07	24 ea	4.56/0.50
4572 Δ	J-Jar Lid only	07	24 ea	1.44/0.18
4573	Caddy with 3 J-Jars & Lids	07	1 ea	1.75/0.27
4575 Δ	8 oz J-Jar with Lid	07	24 ea	5.65/0.67
Bud Vases				
4650	4" Acrylic Bud Vase	07	12 ea	6.10/0.32
4651	6" Acrylic Bud Vase	07	12 ea	6.10/0.32

NSF Listed products are designated with a Δ and may be prefixed with an N



SERVING BASKETS

Woven Baskets

- Handmade natural beauty combined with easy care
- Resistant to mold and mildew
- Microwave safe
- Dishwasher safe



Munchie Baskets™

- Excellent for serving a deli sandwich or a specialty appetizer
- Stackable and dishwasher safe
- See pages 324-325 for imprinting information



The industry's only basket with custom imprinting



Prod No	Description	Color	Pack	Cs Wt/Cube
Woven Baskets				
6550	9" x 6.25" Small Oval Basket	03, 25	6 ea	1.50/0.29
6551	11.75" x 7.75" Medium Oval Basket	03, 25	6 ea	2.00/0.55
6552	11.5" x 8.5" Rectangle Oval Basket	03, 25	6 ea	3.00/0.58
6553	9" Small Round Basket	03, 25	6 ea	2.50/0.55
6555	11" Medium Round Basket	03, 25	6 ea	2.00/0.55
Munchie Baskets				
44030	10.38" x 8" Munchie Basket	03, 05	24 ea	4.50/0.36
44031	7.38" x 5.38" Munchie Basket	03, 05	12 ea	4.50/0.37



WeaveWear™ Baskets & Platter

- For serving chips, fries, sandwiches, finger foods, or kids' meals
- Wicker weave pattern exterior with smooth, easy to clean interior
- Safe alternative to wicker and plastic coated wire
- Made of durable FDA grade polypropylene
- Wide diameter and raised bottom design on 6527 creates a unique presentation for your signature sandwich, appetizer, or specialty item
- Dishwasher safe



Wicker Look Basket

- Elegant baskets for serving chips, fries, sandwiches, finger foods, or kids' meals
- Design features a detailed wicker weave patterned exterior
- Smooth, easy-to-clean interior
- Made of durable, scratch-resistant polycarbonate



Bread & Bun Basket

- Extremely economical basket is great for all types of food such as sandwiches, fries, ribs, chips, or breads



Basket Server

- Break-resistant SAN baskets can be used for holding tall items like bread sticks or can be used as an ice bucket for table or room service
- Safe for use in temperatures from 0° to 180°F
- Dishwasher safe



Prod No	Description	Color	Pack	Cs Wt/Cube
<div style="display: flex; justify-content: space-around; font-size: small;"> Brown(01) Black(03) Red(05) Clear(07) Green(09) Light Brown(31) Straw(67) </div>				
WeaveWear Baskets & Platter				
6504	9" x 6.25" Oval WeaveWear Basket	01, 03, 05, 09, 67	12 ea	3.90/0.37
6524	9" Round WeaveWear Basket	01, 03, 05, 09, 67	12 ea	5.30/0.40
6526	12" Round WeaveWear Basket	01, 03, 05, 09, 67	12 ea	8.00/0.79
6527	10.38" Round WeaveWear Platter	03, 31	12 ea	7.65/1.04
Wicker Look Basket				
WB965	9.44" x 6.63" Oval Basket	07	6 ea	3.30/0.44
Bread & Bun Basket				
0333	9.25" x 6" Oval Basket	03, 05	36 ea	4.41/0.72
Basket Server				
356	6.5" Basket, 3 qt	07	6 ea	7.10/0.99



TORTILLA SERVERS

Interlocking base & lid design allows for stacking several tortilla servers at one time

Tortilla Servers

- Lid has easy-grip, recessed handle
- Durable polycarbonate tortilla servers withstand temperatures up to 212°F
- Polypropylene servers are easy-clean, long-lasting, and economical; withstand temperatures up to 190°F
- NSF Listed; dishwasher safe

US Patent No. D-331351



Salsa and Molcajete Dishes on page 50

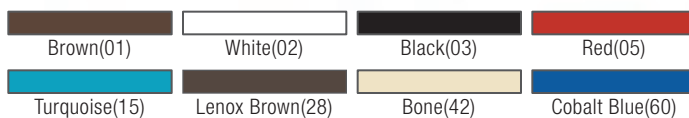

Prod No	Description	Color	Pack	Cs Wt/Cube
Interlocking Tortilla Servers & Lids				
0470 Δ	7.5" PC Tortilla Server	01, 02, 03, 05, 15, 60	24 ea	16.22/1.80
0475 Δ	7.5" PPY Tortilla Server	03, 05, 28, 42	24 ea	12.31/1.80

NSF Listed products are designated with a Δ and may be prefixed with an N



Aztec Tortilla Servers

- Unique Aztec design works well in any traditional Mexican or Tex-Mex restaurant
- 8" and 12" servers available in a lift off lid model
- 7" server available with hinged lid for easy one handed access
- Thick walled polypropylene material helps keep tortillas warm for table service
- Microwaveable, safe for temperatures up to 190°F
- Servers are stackable
- NSF Listed; dishwasher safe



Prod No	Description	Color	Pack	Cs Wt/Cube
Aztec Tortilla Servers & Lids				
0710 Δ	7" Hinged Tortilla Server	03, 29	12 ea	12.26/1.01
0713 Δ	8" Lift Off Tortilla Server	03, 29	12 ea	21.00/2.47
0717 Δ	12" Lift Off Tortilla Server	03, 08, 29	6 ea	21.00/2.12
0700 Δ	7" Hinged Replacement Lid	03, 29	12 ea	3.50/0.27
0703 Δ	8" Replacement Lid	03, 08, 14, 29	12 ea	7.00/0.60
0707 Δ	12" Replacement Lid	03, 08, 14, 29	6 ea	8.00/0.76

NSF Listed products are designated with a Δ and may be prefixed with an N



SERVING TRAYS & ACCESSORIES

Round Serving Trays

- Serving Trays are perfect for bar service or individual meals including salads, sandwiches, or burgers
- Perfect size for iced seafood platters
- Made of heavy-duty, break-resistant melamine
- NSF Listed; dishwasher safe



1300



44532

Roll-Top Covered Dishes

- Multi-purpose roll-top dishes are perfect for serving sugar, candies, sauces, or dressings
- High-polish 18-8 stainless steel
- Handwashing recommended



609132

609131

609133



Prod No	Description	Color	Pack	Cs Wt/Cube
Serving Trays				
44532 Δ	11.5" Round Melamine Serving Tray	03	12 ea	12.19/0.61
1300 Δ	13" x 1.5" Melamine Serving Tray	01, 02, 60	12 ea	13.50/1.01
Roll-Top Covered Dishes				
609131	10 oz Roll-Top Covered Dish	—	12 ea	5.80/0.67
609132	14 oz Roll-Top Covered Dish	—	12 ea	9.55/1.53
609133	30 oz Roll-Top Covered Dish	—	1 ea	1.42/0.24

NSF Listed products are designated with a Δ and may be prefixed with an N



Allegro™ Number Stands

- Use taller card holders to identify banquet seating or reserved tables and shorter holders for place cards or on buffet lines
- Heavy-weight base prevents accidental tipping
- 18-10 mirror polish finish



Dual Booster Seats

- Two-sided seat offers a choice of heights
- Extra-strong, one-piece molded design with wide square base for better stability
- Anti-skid pads on both sides prevent sliding

Booster Seat With Safety Strap

- Strap secures to chair to increase child safety
- Snap clasp and adjustable strap for use behind chair back or under seat

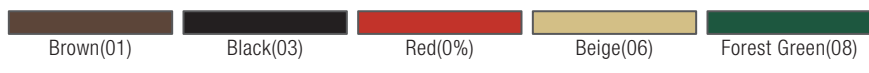

Prod No	Description	Color	Pack	Cs Wt/Cube
Number Stands				
609179	4" Allegro Number Stand	—	6 ea	1.50/0.06
609183	8" Allegro Number Stand	—	6 ea	3.00/0.17
Dual Booster Seat				
7110	Booster Seat	01, 03, 05, 06, 08	4 ea	16.50/3.99
Booster Seat with Safety Strap				
7111-4	Booster Seat with Safety Strap	01, 03, 05, 06	4 ea	16.50/3.95
Replacement strap				
7112	Replacement Strap	03	12 ea	2.00/0.43

Note: 7110, 7111-4 can ship UPS/FedEx Ground at oversize cost



CARLISLE
FOODSERVICE PRODUCTS

BEAUTIFUL
QUALITY
ELEGANT
PROTECTIVE
HANDMADE
MARKO
TABLE
COVERINGS

*No room is complete without the finishing touches
and setting an exceptional table begins with quality
products. Marko offers the finest quality of textiles to
help you achieve that perfect look.*



IN-STOCK PROGRAM

Carlisle FoodService is pleased to announce the Marko In-Stock Program. For the very first time, **the most requested Marko table coverings, napkins, skirting and accessories are now available as stocked items.** No longer will you have to place a separate order for your most sought after Marko items. With Carlisle FoodService, **you can count on Marko** to be there for you.

Ordering Information:

- In-Stock items can be combined on one purchase order with foodservice products
- In-Stock items can be combined with made-to-measure items
- Combined orders of In-Stock items and made-to-measure items will ship together upon completion of the made-to-measure items

Note:

- Made-to-measure items cannot be combined with foodservice orders

This is just the beginning—additional items will be added based on demand.

For more information please contact your sales representative.



Table Linens

A smooth luxurious feel and a natural, soft texture between your fingers. Marko SoftWeave table linens and napkins, made of spun filament polyester, deliver the soft feel of cotton, yet don't lint, pill, shrink, or fade like cotton. Thanks to an advanced finishing technology, our SoftWeave is able to remain elegant and soft to the touch longer than spun or 50/50 blended polyester. SoftWeave combines style and sophistication with the performance features and low cost efficiencies you desire. Our advanced stain release technology allows you to wash at a low 120°F rather than 160°F while using half the detergent, dramatically lowering your energy costs.



SoftWeave Square



SoftWeave Round



Classic Twill Skirting w/ SoftWeave Tablecloth

Napkins

Made from our signature SoftWeave fabric, it is amazing how a cloth napkin can add to a dining experience. Enhance the atmosphere of your facility and turn an ordinary dinner, or a "quick bite to eat" into a memorable meal or night on the town. Using cloth napkins can keep your customers coming back for more and for less than you think.



SoftWeave Napkins

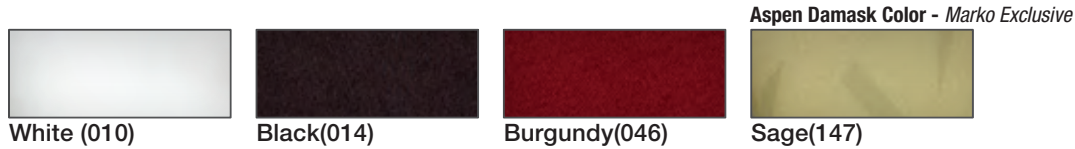

Item	Description	Dimensions	Color	Pack
Fabric Tablecloths				
53785252SM010	SoftWeave Tablecloth	52" x 52"	White	1 ea
53785252SM014	SoftWeave Tablecloth	52" x 52"	Black	1 ea
53785252SM046	SoftWeave Tablecloth	52" x 52"	Burgundy	1 ea
537852AITM010	SoftWeave Tablecloth	52" x 108"	White	1 ea
53785454SM010	SoftWeave Tablecloth	54" x 54"	White	1 ea
537854AUTM010	SoftWeave Tablecloth	54 x 120"	White	1 ea
53785858SM010	SoftWeave Tablecloth	58" x 58"	White	1 ea
53787272SM010	SoftWeave Tablecloth	72" x 72"	White	1 ea
537876RM010	SoftWeave Tablecloth	76" Round	White	1 ea
537890RM010	SoftWeave Tablecloth	90" Round	White	1 ea
53935252SM147	SoftWeave Aspen Damask Tablecloth	52" x 52"	Sage	1 ea
Fabric Napkins				
53781717NM010	SoftWeave Napkins	17" x 17"	White	12 ea
53781717NM014	SoftWeave Napkins	17" x 17"	Black	12 ea
53781717NM046	SoftWeave Napkins	17" x 17"	Burgundy	12 ea
53782020NM010	SoftWeave Napkins	20" x 20"	White	12 ea
53782020NM014	SoftWeave Napkins	20" x 20"	Black	12 ea
53782020NM046	SoftWeave Napkins	20" x 20"	Burgundy	12 ea
53931717NM147	SoftWeave Aspen Damask Napkins	17" x 17"	Sage	12 ea
53932020NM147	SoftWeave Aspen Damask Napkins	20" x 20"	Sage	12 ea

Vinyls

Whether you are looking for the classic checkered vinyl or a new upscale pattern to complete your dining room look, Marko's vinyl has that and everything in between including the elegance and drape of fabric.



Classic™ Series (Red Check)

Skirting

From banquets, weddings, and buffet lines to meetings, conferences and registration tables, the use for table skirting is limitless. Our TruFinish™ Classic™ Twill skirting, made from 100% filament polyester doesn't fade and resists wrinkles for an elegant presentation.

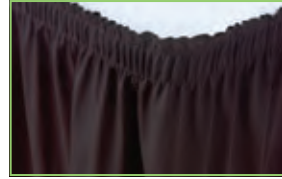

Classic Twill Black



Classic Twill White



Add Some Sparkle To Your Table Top With Glimmer

Combine Glimmer or one of our other vinyls with traditional table skirting to get the best of both worlds. Vinyls provide an easy wipe off surface for quick spill clean up. Traditional fabric skirting adds the soft touch – perfect for weddings, receptions, buffets, or other special events.

Classic Twill

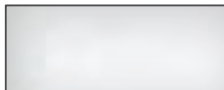

White(010)



Black(014)

Classic Check



Red(001)

Expression Trellis



Coppertone(012)

Vative Rove

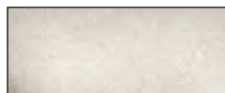

Stone(382)

Vative Glimmer

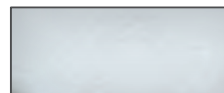

Metallic Silver(625)

Item **Description** **Dimensions** **Color** **Pack**

Vinyl Tablecloths

51515252SM001	Classic Series - Classic Check	52" x 52"	Red	1 ea
57285252SM012	Expression Series - Trellis	52" x 52"	Coppertone	1 ea
59035252SM382	Vative Series - Rove	52" x 52"	Stone	1 ea
59085252SM625	Vative Series - Glimmer	52" x 52"	Metallic Silver	1 ea

Fabric Skirting

5024CE29AF010	Classic Twill Shirred Pleat Skirting w/Velcro Header & 24 Clips	13'	White	1 ea
5024CE29AF014	Classic Twill Shirred Pleat Skirting w/Velcro Header & 24 Clips	13'	Black	1 ea
5024EG29AF010	Classic Twill Shirred Pleat Skirting w/Velcro Header & 31 Clips	17.5'	White	1 ea
5024EG29AF014	Classic Twill Shirred Pleat Skirting w/Velcro Header & 31 Clips	17.5'	Black	1 ea
5024FW29AF010	Classic Twill Shirred Pleat Skirting w/Velcro Header & 38 Clips	21'	White	1 ea
5024FW29AF014	Classic Twill Shirred Pleat Skirting w/Velcro Header & 38 Clips	21'	Black	1 ea





Clips

Marko offers specifically designed clips to fit a variety of table edges. From our lifetime guarantee on our metal clips to our polycarbonate plastic clips, Marko has everything you need to pull your look together.

Overlock & Valance

5CC55PC-12



Metal

5CC118MP-12



Metal

5CC120MP-12



Plastic

5CC200PC-12



Plastic

5CCCCLIP-12



Plastic

5CCLCLIP-12



Item	Description	Dimensions	Pack
Accessories			
5CC55PC-12	Overlock & Valance Clip, Hook & Loop Header	1/2"	12 ea
5CC118MP-12	Metal Skirting Clip, Hook & Loop Header	3/8" - 1-1/4"	12 ea
5CC120MP-12	Metal Skirting Clip, Hook & Loop Header	1-1/4" - 2-1/4"	12 ea
5CC200PC-12	Plastic Skirting Clip, Hook & Loop Header	3/8" - 3/4"	12 ea
5CCCCLIP-12	Plastic Skirting Clip, Hook & Loop Header	3/4" - 2"	12 ea
5CCLCLIP-12	Large Plastic Skirting Clip, Hook & Loop Header	1-1/2" - 2-1/2"	12 ea



STYLISH BREAK- RESISTANT CONTEMPO- RARY ELEGANT **DISPLAYWARE**

How you display your culinary creations is what brings your guests in. Carlisle has everything you need to provide an organized, attractive, and safe food service environment.



MELAMINE DISPLAYWARE

Balsam display ware is your **Eco-friendly** choice for displaying your prepared food in front of your guest. This displayware is made from **50% sustainable natural resources** vs. 20% in standard melamine, making Balsam **one of the most environmentally friendly commercial grade melamines on the market.**

DISPLAYWARE

Balsam™

- Contains a material that will begin to biodegrade in 90 days in a compostable environment
- Withstands the rigors of commercial foodservice dishwasher use
- Maintains its appearance after one year of dishwasher testing
- Durable melamine is stain, scratch- and break-resistant, making it ideal for any foodservice operation
- Safe for temperatures up to 212°F
- NSF Listed; dishwasher safe



55550
55526



55532

55542



55546



55544



Bavarian Cream(37)

Prod No	Description	Color	Pack	Cs Wt/Cube
Balsam Displayware				
55520 ▲	1" Deep Full Size Pan	37	6 ea	17.89/0.67
55522 ▲	2.5" Deep Full Size Pan	37	6 ea	22.88/1.77
55524 ▲	4" Deep Full Size Pan	37	6 ea	27.63/2.83
55526 ▲	1" Deep Half Long Size Pan	37	6 ea	9.97/0.43
55528 ▲	2.5" Deep Half Long Size Pan	37	6 ea	13.64/1.02
55530 ▲	4" Deep Half Long Size Pan	37	6 ea	17.67/1.34
55532 ▲	1" Deep Half Size Pan	37	6 ea	9.71/0.39
55534 ▲	2.5" Deep Half Size Pan	37	6 ea	12.87/0.93
55536 ▲	4" Deep Half Size Pan	37	6 ea	16.15/1.38
55538 ▲	1" Deep Third Size Pan	37	6 ea	6.97/0.25
55540 ▲	2.5" Deep Third Size Pan	37	6 ea	9.55/0.59
55542 ▲	4" Deep Third Size Pan	37	6 ea	12.25/0.85
55544 ▲	26 oz Angled Bowl	37	6 ea	5.35/0.40
55546 ▲	3 qt Angled Bowl	37	6 ea	9.48/1.16
55550 ▲	26 oz Square Bowl	37	6 ea	4.90/0.08

NSF Listed products are designated with a ▲ and may be prefixed with an N



Customers respond to the presentation of prepared food. **Make your presentation irresistible** with our Flared bowls. The shape and flare **draw the eye into the food inside.**

Flared Square Bowls

- Large display bowls coordinate with many other Carlisle pieces
- High quality, heavy-weight melamine
- Safe for temperatures up to 212°F
- NSF Listed; dishwasher safe



Prod No	Description	Color	Pack	Cs Wt/Cube
Flared Square Bowls				
33360 Δ	5 qt, 11.75" Small Flared Bowl	02, 03	4 ea	8.64/0.75
33362 Δ	8 qt, 13.75" Medium Flared Bowl	02, 03	4 ea	11.53/1.06
33364 Δ	15.5 qt, 16.88" Large Flared Bowl	02, 03	4 ea	15.36/1.47

NSF Listed products are designated with a Δ and may be prefixed with an N

MELAMINE DISPLAYWARE

The **contemporary design of Rave is the versatile choice for your displays.** Rave suits many types of cuisine and the interesting shapes create a playful display that will **draw guests to your culinary offerings.**

Rave®

- Offers the look and feel of china without the replacement cost
- Bowls lock into pedestal for secure serving
- Skid-resistant feet
- Safe for temperatures up to 212°F
- Dishwasher safe



Prod No	Description	Color	Pack	Cs Wt/Cube
Rave Displayware				
33310	7" Rave Serving Bowl	02, 03	6 ea	9.52/0.59
33312	10" Rave Serving Bowl	02, 03	6 ea	15.60/0.97
33314	12" Rave Salad Bowl	02, 03	6 ea	16.21/1.09
33316	13" Rave Starburst Bowl	02, 03	6 ea	12.10/1.61
33318	15" Rave Bowl with Rim	02, 03	6 ea	17.32/1.61
33320	10" Rave Rectangular Platter	02, 03	6 ea	3.77/0.31
33322	16" Rave Rectangular Platter	02, 03	6 ea	8.79/0.26
33324	23" Rave Rectangular Platter	02, 03	6 ea	12.96/0.47
33326	16" Rave Trapezoid Platter	02, 03	6 ea	10.31/0.48
33302	4" Rave Pedestal	02, 03	12 ea	6.94/0.93

NSF Listed products are designated with a **▲** and may be prefixed with an N





The oversized scalloped platters are **perfect for display, deli and tabletop presentations**. This collection **easily coordinates with many other Carlisle pieces**.

Scalloped Platters

- High quality, heavy-weight melamine
- Safe for temperatures up to 212°F
- NSF Listed; dishwasher safe



Terra is a longtime Carlisle customer favorite! The **organic design and exceptional quality** make it popular for buffet and display case use.

Terra®

- Unique textured platters add depth
- Safe for temperatures up to 212°F
- NSF Listed; dishwasher safe



Prod No	Description	Color	Pack	Cs Wt/Cube
Scalloped Platters				
7924 Δ	14.5" Square Small Scalloped Tray	02, 03	4 ea	11.53/0.46
7926 Δ	16.81" Square Medium Scalloped Tray	02, 03	4 ea	14.81/0.74
7928 Δ	18.81" Square Large Scalloped Tray	02, 03	4 ea	18.37/0.83
7944 Δ	19.5" x 13" Rectangular Small Scalloped Tray	02, 03	4 ea	12.43/0.58
7946 Δ	22.5" x 14.5" Rectangular Medium Scalloped Tray	02, 03	4 ea	16.10/0.72
7948 Δ	24.5" x 18.5" Rectangular Large Scalloped Tray	02, 03	4 ea	21.07/1.04
Terra Displayware				
44514 Δ	14" Round Textured Platter	02, 03	12 ea	22.22/0.87
44518 Δ	18" Round Textured Platter	02, 03	12 ea	40.70/2.02
44520 Δ	13.5" x 9.25" Rectangular Textured Platter	02, 03	4 ea	6.41/0.47
44522 Δ	15.5" x 11" Rectangular Textured Platter	02, 03	4 ea	8.80/0.64
44524 Δ	18" x 12.5" Rectangular Textured Platter	02, 03	4 ea	12.75/0.84

NSF Listed products are designated with a Δ and may be prefixed with an N



MELAMINE DISPLAYWARE

The palette Designer series is our **lighter weight melamine** displayware and is **perfect for large food presentations**. We offer a **wide rim style that frames your food beautifully**.

Palette Designer Displayware®

- Combine with decorated Palette pieces for attention getting displays in the deli case or buffet line
- Break-resistant construction reduces replacement costs
- High quality, heavy-weight melamine
- Safe for temperatures up to 212°F
- NSF Listed; dishwasher safe

Wide Rim

- Use with displayware covers shown on the facing page



Prod No	Description	Cover	Color	Pack	Cs Wt/Cube
Palette Designer Displayware					
43024 Δ	12" Wide Rim Round Plate	1994*	02	12 ea	18.10/0.54
44400 Δ	12" Wide Rim Square Plate	44400C	02, 03	4 ea	7.69/0.29
44402 Δ	14" Wide Rim Square Bowl	44402C	02, 03	4 ea	12.00/0.68
44404 Δ	15" Wide Rim Round Platter	44404C	02, 03	4 ea	9.28/0.39
44406 Δ	19" Wide Rim Round Platter	—	02, 03	4 ea	14.63/0.81
44410 Δ	17" X 13" Wide Rim Oval Platter	44410C	02, 03	4 ea	9.51/0.46
44412 Δ	21" X 15" Wide Rim Oval Platter	44412C	02, 03	4 ea	13.63/0.69
44414 Δ	14" X 10" Wide Rim Rectangle Platter	44414C	02, 03	4 ea	7.53/0.22
44416 Δ	17" X 13" Wide Rim Rectangle Platter	44416C	02, 03	4 ea	11.63/0.44
44418 Δ	22" Wide Rim Salmon Platter	44418C	02, 03	4 ea	7.70/0.34

NSF Listed products are designated with a Δ and may be prefixed with an N
 *1994 Plate Cover can be found in the Dinnerware section of this catalog



Food Pans

- 2.5" and 4" deep pans can be turned over and used as display stands
- Combine with display covers shown on the facing page to create an attractive merchandising display
- NSF Listed; dishwasher safe



Palette Displayware Covers

- Designed to work with selected pieces of our Palette Displayware
- Clear polycarbonate covers are highly heat- and break-resistant
- Allows you to safely protect and transport dishes prepped in advance
- Stack for compact storage
- Dishwasher safe



Prod No	Description	Cover	Color	Pack	Cs Wt/Cube
Palette Designer Displayware Food Pans					
44420 Δ	1" D Full Size Food Pan	44422C	02, 03	6 ea	22.00/0.68
44422 Δ	2.5" D Full Size Food Pan	44422C	02, 03	6 ea	25.30/1.01
44430 Δ	1" D Half Size Food Pan	44432C	02, 03	6 ea	10.78/0.34
44432 Δ	2.5" D Half Size Food Pan	44432C	02, 03	6 ea	12.61/0.55
44460 Δ	1" D Third Size Food Pan	44462C	02, 03	6 ea	7.70/0.22
44462 Δ	2.5" D Third Size Food Pan	44462C	02	6 ea	10.40/0.60
Palette Designer Displayware Covers					
44400C	Cover for 12" Wide Rim Square Plate	—	07	12 ea	12.50/0.29
44402C	Cover for 14" Wide Rim Square Platter	—	07	12 ea	6.00/3.19
44410C	Cover for 17" x 13" Wide Rim Oval Platter	—	07	12 ea	15.40/1.42
44414C	Cover for 14" x 10" Wide Rim Rectangle Platter	—	07	12 ea	7.51/1.71
44416C	Cover for 17" x 13" Wide Rim Rectangle Platter	—	07	12 ea	17.75/1.42
44418C	Cover for 22" Wide Rim Salmon Platter	—	07	12 ea	14.50/1.14
44422C	Cover for Full Size Food Pan	—	07	12 ea	18.48/1.72
44432C	Cover for Half Size Food Pan	—	07	12 ea	12.00/1.47
44462C	Cover for Third Size Food Pan	—	07	12 ea	7.51/0.77

NSF Listed products are designated with a Δ and may be prefixed with an N

MELAMINE DISPLAYWARE

These 6 versatile pieces coordinate beautifully with our **Epicure Dinnerware** pieces that are offered **on page 15**

Epicure® Displayware

- Stain- and scratch-resistant finish
- Made of dependable, impact-resistant melamine
- Safe for temperatures up to 212°F
- NSF Listed; dishwasher safe



Narrow rimmed platters provide a larger landscape for your food presentations. Carlisle offers **5 shapes and sizes** to give you the perfect size for your application.

Narrow Rimmed Displayware

- Rimmed style displayware in a variety of shapes
- Stain- and scratch-resistant finish
- Made of dependable, impact-resistant melamine
- Safe for temperatures up to 212°F
- NSF Listed; dishwasher safe



Prod No	Description	Color	Pack	Cs Wt/Cube
Epicure Displayware				
ARR240 Δ	46 oz, 9" Round Open Vegetable Bowl	02	12 ea	8.40/0.51
5933 Δ	32 oz, 8.25" Round Bowl	02	24 ea	17.75/1.28
43737 Δ	24 oz, 7.38" Footed Serving Bowl	02, 03	12 ea	5.00/0.35
43738 Δ	36 oz, 8.63" Footed Serving Bowl	02	12 ea	7.00/0.53
43739 Δ	57 oz, 9.25" Footed Serving Bowl	02	12 ea	10.00/0.77
43842 Δ	14" x 10" Oblong Platter	02, 03	12 ea	11.00/0.48
Narrow Rimmed Displayware				
ARR112 Δ	14.75" x 10.5" Oval Platter	02	12 ea	15.00/0.89
ARR120 Δ	12" x 8.5" Oval Platter	02, 25	12 ea	7.10/0.42
43745 Δ	28 oz, 10" x 7.5" Baker/Server	02, 25	12 ea	7.30/0.43
43840 Δ	21" x 15" Catering Platter	02, 03	6 ea	11.75/1.10
43772 Δ	15.5" x 10.5" Oblong Platter	02	12 ea	13.30/0.47

NSF Listed products are designated with a **Δ** and may be prefixed with an N





Salad Bowl

- Made of dependable, impact-resistant melamine
- Safe for temperatures up to 212°F
- NSF Listed; dishwasher safe



1250B shown with 7901

1000B

Scalloped DeliWare® & Inset

- Low profile reduces food waste without sacrificing presentation
- 5.5" Square Scalloped Dish is designed to use alone or as an inset in the 18" x 7" Scalloped Platter (7932)
- Use the combination of our inset and platter for displaying foods with toppings or sauces
- Durable melamine material
- NSF Listed; dishwasher safe



7930

7934

7932



Prod No	Description	Color	Pack	Cs Wt/Cube
Melamine Salad Bowls				
1000B Δ	1.9 qt, 10" Bowl	03	6 ea	7.10/0.45
1250B Δ	3.7 qt, 12" Bowl	03	6 ea	10.20/0.71
Scalloped DeliWare & Inset				
7930 Δ	14" x 10" Scalloped Baker	03	4 ea	6.95/0.44
7932 Δ	18" x 7" Scalloped Platter	03	4 ea	6.95/0.33
7934 Δ	5.5" Square Scalloped Dish/Inset	03	48 ea	22.44/0.46

NSF Listed products are designated with a Δ and may be prefixed with an N

DISPLAYWARE

Designer Displayware®

- Heavy, china/ceramic feel and look without the breakage
- Perfect for salads and entrées in family style dining, banquets, buffets, or deli display cases
- Select pieces available in unique two-tone Mosaic colors
- FDA approved material
- Safe for temperatures up to 212°F
- NSF Listed; dishwasher safe



DISPLAYWARE



Prod No	Description	Color	Pack	Cs Wt/Cube
Designer Displayware				
7910 Δ	5 lb, 10.5" Designer Pasta Bowl	02, 03	4 ea	5.45/0.46
7913 Δ	10 lb, 13" Designer Pasta Bowl	02, 03	4 ea	9.45/0.83
7914 Δ	2 qt, 14" x 10" Oval Designer Platter	02, 03	4 ea	6.30/0.42
7916 Δ	3 qt, 16" x 12" Oval Designer Platter	02, 03	4 ea	8.20/0.63
7918 Δ	4 qt, 19" x 13.75" Oval Designer Platter	02, 03	4 ea	12.25/0.95
7919 Δ	2.9 qt, 9" x 12" Designer Baker	02, 03	4 ea	7.30/0.33
7920 Δ	4 qt, 10" x 14" Designer Baker	02, 03	4 ea	8.10/0.62
Mosaic Designer Displayware				
8910 Δ	5 lb, 10.5" Mosaic Pasta Bowl	406	4 ea	5.60/0.42
8919 Δ	2.9 qt, 9" x 12" Mosaic Baker	406	4 ea	7.25/0.49
8920 Δ	4 qt, 10" x 14" Mosaic Baker	406	4 ea	8.10/0.62

NSF Listed products are designated with a Δ and may be prefixed with an N



Elevate your creations! Carlisle plate stands are available in 2 sizes and 2 colors and **work well with the pieces listed below.**

Plate Stands

- High quality, heavy-weight melamine
- Two height choices add dimension to deli cases or buffets
- Use with a variety of plates and platters including 43024, 44404, and 44406
- NSF Listed; dishwasher safe



Scoop Bowl

- 4 qt bowls are perfect for buffets or salad bar
- Durable SAN plastic is resistant to food oils and acids
- For use in temperatures from 0° to 180°F
- Dishwasher safe



Prod No	Description	Color	Pack	Cs Wt/Cube
Plate Stands				
7900 Δ	2.75" H Plate Stand	02, 03	4 ea	4.03/0.51
7901 Δ	4" H Plate Stand	02, 03	4 ea	4.36/0.49
Scoop Bowl				
0411	4 qt, 13.75" x 9.38" Scoop Bowl	02, 03	4 ea	5.69/0.74

NSF Listed products are designated with a Δ and may be prefixed with an N

DISPLAYWARE

Tulip Deli® Crocks & Platter

- Beautiful swirl pattern and high gloss finish
- Crocks and platters nest for easy storage
- Durable SAN plastic is resistant to food oils and acids
- Safe for use in temperatures from 0° to 180°F
- Dishwasher safe



Orchid® Deli Bowls

- Polycarbonate bowls and crocks have a beautiful, glass-like appearance without the breakage
- Extremely break-resistant material can be used in heated cases or on hot tiles up to 212°F
- Withstands exposure to food acids
- NSF Listed; dishwasher safe



Prod No	Description	Color	Pack	Cs Wt/Cube
Tulip Deli Crocks & Platter				
6963	5 lb, 10.38" x 6.75" Tulip Deli Crock	02, 03, 05	6 ea	5.46/0.57
6966	10 lb, 13" x 10.38" Tulip Deli Crock	02, 03, 05	6 ea	8.20/1.02
Orchid Deli Bowls				
6531 Δ	1.5 qt, 8" Orchid Deli Bowl	03	12 ea	4.70/0.51
6532 Δ	3 qt, 10" Orchid Deli Bowl	03	12 ea	7.45/1.09
6534 Δ	7 qt, 12" Orchid Deli Bowl	03	12 ea	12.55/1.84

NSF Listed products are designated with a Δ and may be prefixed with an N





Octagon Bowls

- Contemporary octagonal shape is ideal for table service, buffets, salad bars or deli displays
- Made of glossy acrylic
- 8888 offers the increased durability of SAN and is safe for use in temperatures from 32° to 160°F
- Dishwasher safe



Octagonal Crocks & Platter

- Crock inserts eliminate waste while giving a full appearance
- 2.5 lb low profile crock (6723) can be used as an insert for the 5 lb crock
- 5 lb low profile crock (6726) can be used as an insert for the 10 lb crock
- Durable SAN plastic is resistant to food oils and acids
- Safe for use in temperatures from 0° to 180°F
- Dishwasher safe



Prod No	Description	Color	Pack	Cs Wt/Cube
Octagon Bowls				
8886	2.5 lb, 7.13" x 2.87" Octagon Bowl	03	4 ea	1.60/0.30
8887	5 lb, 9.19" x 3.04" Octagon Bowl	03	4 ea	3.25/0.55
8888	8 lb, 9.38" x 4.1" Dia Deep Octagon Bowl	03	4 ea	4.00/0.50
Octagonal Crocks & Platter				
6713	5 lb, 10.63" x 7.19" Octagonal Crock	03	6 ea	5.25/0.58
6723	2.5 lb Low Profile Octagonal Crock (and Insert for 5 lb Crock 6713)	02, 03	6 ea	4.50/0.42
6716	10 lb, 13.31" x 10.5" Octagonal Crock	03	6 ea	8.20/1.02
6726	5 lb Low Profile Octagonal Crock (and Insert for 10 lb Crock 6716)	02, 03	6 ea	7.60/0.63

DISPLAYWARE

Make waves with our modular displayware! This modular melamine display system gives you so many options in setting up your display and it all looks perfectly organized when you are done.

Modular Displayware

- Wave shape offers visual interest while enhancing the display
- Unique, flexible displayware provides an attractive solution for merchandising prepared food
- Fits in standard size food wells
- Half long lid can be used as a display tray for sliced deli meats and cheeses
- Made of tough, break-resistant polycarbonate
- Safe for use in temperatures ranging from -40° to 212°F
- NSF Listed; dishwasher safe



Collar provides support for smaller pans when used in a food well



Prod No	Description	Color	Pack	Cs Wt/Cube
Modular Displayware				
6982 Δ	4.45 qt Half Long Pan - Wavy Edge	03, 07	6 ea	9.30/1.26
6990 Δ	4.45 qt Half Long Pan - Straight Edge	03, 07	6 ea	9.37/1.06
6982L Δ	Half Long Lid	07	6 ea	5.11/0.40
6988 Δ	Half Long Collar	03, 07	6 ea	5.48/0.98
6984 Δ	6.5 cup, 2.5" Deep Half Size Pan	03, 07	6 ea	3.67/0.54
69844 Δ	9.25 cup, 4" Deep Half Size Pan	03, 07	6 ea	4.26/0.48
69846 Δ	13 cup, 6" Deep Half Size Pan	03, 07	6 ea	5.34/0.39
6984L Δ	Half Size Lid	07	6 ea	1.95/0.16
6986 Δ	4 cup, 2.5" Deep Third Size Pan	03, 07	6 ea	2.67/0.41
69864 Δ	5.6 cup, 4" Deep Third Size Pan	03, 07	6 ea	3.06/0.34
69866 Δ	7.8 cup, 6" Deep Third Size Pan	03, 07	6 ea	3.87/0.39
6986L Δ	Third Size Lid	07	6 ea	1.36/0.14

NSF Listed products are designated with a Δ and may be prefixed with an N





Rectangular Deli Crocks & Platter

- Rectangular deli crocks save space in display cases
- Acrylic crocks have a high gloss finish
- Safe for use in temperatures from 32° to 160°F
- Dishwasher safe



Deliware® Rectangular Crocks

- Economical durable polypropylene for maximum impact resistance in cold temperatures
- Safe for use in temperatures from 32° to 170°F



Prod No	Description	Color	Pack	Cs Wt/Cube
Rectangular Deli Crocks & Platter				
8508	12" x 8" Rectangular Platter	03	6 ea	5.10/0.41
8819	5 lb , 10" x 6" Rectangular Crock	03	4 ea	2.80/0.55
8821	10 lb, 12" x 10" Rectangular Crock	03	4 ea	5.25/0.92
Deliware Rectangular Crocks				
8110	5 lb, 10" x 6" Rectangular Crock	02, 03	12 ea	7.30/1.18
8112	10 lb, 12.5" x 10.25" Rectangular Crock	02, 03	6 ea	8.75/1.13

DISPLAYWARE

Petal Mist® Plates, Bowls & Trays

- Petal Mist's delicate design gives an elegant appearance; perfect for buffets, food bars, delis, poolside, and catering
- Textured exterior hides scratches; easy-clean smooth interior
- Made of tough, break-resistant polycarbonate
- Safe for use in freezers and in temperatures from 40° to 212°F
- Coordinates with Petal Mist Dinnerware—See page 22
- NSF Listed; dishwasher safe



DISPLAYWARE



Prod No	Description	Color	Pack	Cs Wt/Cube
Petal Mist Plates, Bowls & Tray				
6908 Δ	1.2 qt, 7.5" Petal Mist Bowl	03, 07	36 ea	15.91/1.28
6909 Δ	2.4 qt, 9" Petal Mist Bowl	03, 07	12 ea	8.15/0.69
6931 Δ	3.4 qt, 9.75" Petal Mist Bell Bowl fits 8.25" template opening	03, 07	4 ea	4.10/0.54
6914 Δ	5.6 qt, 12" Petal Mist Bowl	03, 07	4 ea	5.20/0.75
6917 Δ	9.7 qt, 15" Petal Mist Bowl	03, 07	4 ea	8.05/1.17
6919 Δ	17.2 qt, 18" Petal Mist Bowl	03, 07	4 ea	13.00/1.93
6942 Δ	13" Petal Mist Plate	07	6 ea	5.50/0.28
6947 Δ	16" x 22" Petal Mist Rectangular Tray	07	6 ea	15.80/0.45

NSF Listed products are designated with a Δ and may be prefixed with an N



Bell Bowls

- SB90 pebbled design made of crystal-clear acrylic
- 7325 pebbled bowl made of break-resistant polycarbonate
- Dishwasher safe



Stack Bowls

- Use for food bars, buffets, or table service
- 15" deep rim gives a stylish bowl appearance when placed into ice or refrigerated food bar templates
- Acrylic is resistant to food acids and oils
- Dishwasher safe



Leaf Bowls

- Perfect for salad bar or table service
- Acrylic is resistant to food acids and oils
- For use in temperatures from 32° to 160°F
- Dishwasher safe



Buffet Clam Shells

- Perfect for presenting seafood, salads, and appetizers in a buffet or salad bar
- Durable SAN plastic is resistant to food oils and acids
- Safe for use in temperatures from 0° to 180°F
- Dishwasher safe



Prod No	Description	Color	Pack	Cs Wt/Cube
Bell Bowls				
7325	3.3 qt, 11" Polycarbonate Pebbled Bowl	07	12 ea	9.46/0.73
SB90	3.3 qt, 11" Acrylic Pebbled Bowl	07	4 ea	4.00/0.56
SB94	6 qt, 14" Acrylic Pebbled Bowl	07	4 ea	6.25/0.88
Stack Bowls				
8038	1.5 qt, 8" x 3.5" Stack Bowl	03	4 ea	2.85/0.55
8099	2.5 qt, 9" x 3.5" Stack Bowl	03	4 ea	2.85/0.55
8100	3 qt, 9.5" x 4" Stack Bowl	03	4 ea	3.10/0.53
Leaf Bowls				
LB10	1.5 qt, 9.38" Leaf Bowl	07	4 ea	2.80/0.42
LB12	3 qt, 11.25" Leaf Bowl	07	4 ea	4.00/0.65
LB16	8 qt, 15.38" Leaf Bowl	07	4 ea	7.00/1.48
Buffet Clam Shells				
339	12 oz, 8.88" x 5.5" Small Clam Shell	02, 07	12 ea	5.90/0.60
0340	22 oz, 11" x 7" Medium Clam Shell	02, 03, 07	12 ea	10.75/1.15
0344 Δ	5 qt, 19" x 12.88" Large Clam Shell	02, 03, 07	1 ea	3.25/1.20

NSF Listed products are designated with a Δ and may be prefixed with an N

DISPLAYWARE

Round Polycarbonate Pebbled Bowls

- Pebbled exterior resists scratches
- Smooth interior is unaffected by salad oils, food acids, or dressings
- Durable polycarbonate is safe for use in temperatures from 40° to 212°F
- NSF Listed; dishwasher safe



Acrylic Pebbled Bowls

- Acrylic bowls have heat polished, high-gloss rim
- Pebbled finish resists scratches
- Dishwasher safe



Prod No	Description	Color	Pack	Cs Wt/Cube
Round Polycarbonate Pebbled Bowls				
7206 Δ	0.6 qt, 6" Round PC Bowl	07	12 ea	2.15/0.16
7208 Δ	1.62 qt, 8" Round PC Bowl	07	12 ea	5.05/0.52
7210 Δ	3 qt, 10" Round PC Bowl	07	12 ea	8.38/0.86
7212 Δ	5.5 qt, 12" Round PC Bowl	07	12 ea	13.90/1.32
7215 Δ	11 qt, 15" Round PC Bowl	07	4 ea	6.45/1.25
7218 Δ	18 qt, 18" Round PC Bowl	07	4 ea	11.26/2.04
7223 Δ	33 qt, 23" Round PC Bowl	07	4 ea	19.00/4.15
Round Acrylic Pebbled Bowls				
SB66	5 qt, 6" Acrylic Round Bowl	07	8 ea	1.80/0.14
SB68	1 qt, 8" Acrylic Round Bowl	07	4 ea	2.05/0.42
SB70	2 qt, 10" Acrylic Round Bowl	07	4 ea	3.45/0.42
SB72	4 qt, 12" Acrylic Round Bowl	07	4 ea	3.10/0.88
SB74	7 qt, 14" Acrylic Round Bowl	07	4 ea	6.37/0.87
SB76	10 qt, 16" Acrylic Round Bowl	07	4 ea	7.56/1.49
SB78	15 qt, 18" Acrylic Round Bowl	07	4 ea	10.20/2.49
SB79	24 qt, 22" Acrylic Round Bowl	07	4 ea	15.25/2.82
Oval Acrylic Pebbled Bowls				
OSB172	5.5 qt, 10.5" x 14" Acrylic Oval Bowl	07	4 ea	5.38/0.87
OSB176	11 qt, 13" x 18" Acrylic Oval Bowl	03, 07	4 ea	9.95/1.94
OSB178	15 qt, 15.25" x 21.88" Acrylic Oval Bowl	03, 07	4 ea	11.20/1.94

NSF Listed products are designated with a Δ and may be prefixed with an N
Shipping Notes: 7223 and SB79 can ship UPS/FedEx Ground at oversize cost





Double-Wall Stainless Steel Displayware

- Beautiful, heavy-duty, stainless steel displayware designed for delis, buffets, and special event service
- The modern hammered finish hides scratches for a longer life
- Double wall construction provides insulation to help with temperature retention with both hot and cold foods; no need to preheat or chill
- Double wall construction with air insulation prevents sweating for a fresher looking display
- 609201, 609202, 609203, and 609204 bowls have dual-base indentions allowing bowls to sit flat or at an angle for a more dramatic display and easy food access
- Keeps food under 41°F for up to 2 hours or more



Double Wall Construction/Air Insulation:

- Helps with temperature retention for both hot and cold foods
- Keeps food under 41°F for up to 2 hours or more

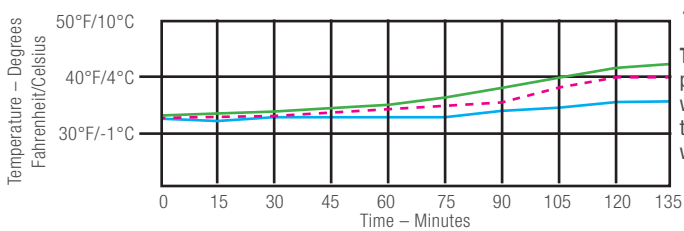

- 609211 3.5 qt, 10" Square Bowl
- 609209 4.38 qt, 10-3/4" Serving Bowl
- 609204 9.5 qt, 14" Dual Angle Bowl

Testing Conditions: Chilled cottage cheese was placed in a room temperature bowl. The bowls were left undisturbed in a 72° to 78°F room until temperatures rose above 40°F. Temperature in center was measured and recorded in 5 minute increments.

Prod No	Description	Pack	Cs Wt/Cube
Double-Wall Stainless Steel Displayware			
609201	1.7 qt, 8" Dual Angle Bowl with Hammered Finish	2 ea	6.39/0.28
609202	3.38 qt, 10" Dual Angle Bowl with Hammered Finish	2 ea	7.94/0.70
609203	5.75 qt, 12" Dual Angle Bowl with Hammered Finish	2 ea	9.31/1.13
609204	9.5 qt, 14" Dual Angle Bowl with Hammered Finish	2 ea	11.69/2.02
609208	2.5 qt, 9.25" Serving Bowl with Hammered Finish	2 ea	7.28/0.60
609209	4.38 qt, 10.75" Serving Bowl with Hammered Finish	2 ea	8.60/0.88
609211	3.5 qt, 10" Square Bowl with Hammered Finish	2 ea	7.94/0.84
609215	12" x 7" Curved Tray with Hammered Finish	2 ea	6.44/0.37
609216	15" x 8.5" Curved Tray with Hammered Finish	2 ea	7.81/0.57

DISPLAYWARE

Balti Dishes

- Handled bowls are great for food preparation and presentation, deli display, or family style dining
- High polish 18-2 stainless steel
- Dishwasher safe



Square Display Dishes

- Handled bowls are great for food preparation and presentation, deli display, or family style dining
- Handles collapse to minimize display space used
- High polish 22 gauge stainless steel
- Dishwasher safe



Allegro® Display Bowls

- Multi-purpose bowls for candies, fruit, dressings, sauces, and rolls
- Mirror-polished finish; 18-10 stainless steel
- Hand washing recommended



Prod No	Description	Pack	Cs Wt/Cube
Balti Dishes - Stainless Steel			
609092	20 oz, 6" Balti Dish	12 ea	7.49/0.29
609093	30 oz, 6.75" Balti Dish	12 ea	7.94/0.29
609094	44 oz, 7.5" Balti Dish	12 ea	9.70/0.45
609096	72 oz, 9.5" Balti Dish	12 ea	11.90/0.54
609097	96 oz, 10.25" Balti Dish	12 ea	12.23/0.77
Square Display Dishes - Stainless Steel			
609082	6" Square Display Dish	12 ea	10.58/0.18
609083	8" Square Display Dish	12 ea	19.18/0.44
609084	10" Square Display Dish	12 ea	19.18/0.44
609085	12" Square Display Dish	12 ea	23.37/0.62
609086	14" Square Display Dish	12 ea	27.56/0.82
Allegro Display Bowls - Stainless Steel			
609171	20 oz, 5.25" Allegro Display Bowl	6 ea	3.50/0.32
609172	26 oz, 5.88" Allegro Display Bowl	6 ea	4.00/0.43
609173	48 oz, 7" Allegro Display Bowl	3 ea	3.00/0.36
609196	3 qt, 9.5" Allegro Display Bowl	1 ea	2.00/0.29

*Note: Not for use in hot wells or ovens





Display Covers (Cover Only)

- Covers enhance and protect the look of your food items; helps keep food fresh
- Use for merchandising fresh fruits, desserts, salads, sandwiches, or bakery items
- Polycarbonate dome covers add increased durability and can be used in more extreme foodservice applications



PSD21EH

Use Display Covers with our full- and half-size food pans shown on pages 216-217

Cake Covers & Tray

- Clear covers display desserts and pastries
- Sanitary covers help keep foods fresher longer
- Dishwasher safe



2512

3004

SC32

Step Risers

- Step Risers create height in your food presentation
- Offers better visibility and helps merchandise foods

Polycarbonate Step Risers

- 6843 polycarbonate riser is virtually unbreakable; won't dent or chip

ABS Step Risers

- Edges have air slots for increased air circulation
- ABS plastic is very durable and easy to clean; will not warp or chip
- Textured satin finish decreases glare, hides scratches



6863

6843



Prod No	Description	Pack	Cs Wt/Cube
Display Covers (Trays Not Included)			
PSD13EH	12" x 10" End Cut Display Cover	1 ea	1.74/0.81
PSD13CH	12" x 10" Center Cut Display Cover	1 ea	1.74/0.81
PSD21EH	12" x 20" End Cut Display Cover	1 ea	3.88/1.72
PSD21CH	12" x 20" Center Cut Display Cover (7.88" x 6.75" opening)	1 ea	3.88/1.72
PSD21DEH	12" x 20" Double End Cut Display Cover	1 ea	3.88/1.72
Cake Covers & Tray			
SC32	12" x 6" Cake Cover, Acrylic	6 ea	7.85/1.70
2512	12" x 6.5" Cake Cover, SAN	6 ea	9.95/1.95
3004	14" Display Tray, SAN	12 ea	11.10/0.55
Step Risers			
6843 Δ	11.75" 3-Step Polycarbonate Riser	1 ea	5.16/1.03
6863	23.5" 3-Step Riser ABS Riser	1 ea	8.65/2.03

NSF Listed products are designated with a Δ and may be prefixed with an N

SERVINGWARE

Venico™

- Adds a classic & sophisticated look to your serving line
- Made from a solid piece of stainless steel with beautiful mirror-finish
- Light-weight; crafted with hollow handles
- Dishwasher safe



Aria™

- Heavy-duty, and more economical than comparable hollow handle items
- Ladles have one ounce oval shaped bowl for pouring dressings from either side



Prod No	Description	Pack	Cs Wt/Cube
Venico			
607650	11" Venico Solid Spoon	12 ea	3.00/0.08
607651	11" Venico Slotted Spoon	12 ea	3.00/0.08
607652	11" Venico Pastry Server	12 ea	3.00/0.08
607653	10.5" Venico Pie Server	12 ea	4.00/0.09
607654	14" Venico Perforated Turner	12 ea	4.00/0.09
607655	11" Venico Ladle with Spout, 1 oz	12 ea	4.00/0.09
607656	11" Venico Ladle with Spout, 2 oz	12 ea	5.00/0.16
607657	12" Venico Ladle, 4 oz	12 ea	6.00/0.19
607658	11" Venico 4-Tine Meat Fork	12 ea	6.00/0.07
Aria			
609001	12" Aria Solid Spoon	12 ea	4.00/0.26
609002	12" Aria Slotted Spoon	12 ea	3.50/0.08
609003	11.5" Aria Notched Spoon	12 ea	3.50/0.08
609005	10.75" Aria Cold Meat Fork	12 ea	2.50/0.05
609006	11.75" Aria Wide Pie Server	12 ea	5.00/0.11
609007	11" Aria Narrow Pastry Server	12 ea	4.00/0.04
609009	10" Aria Solid Spoon	12 ea	3.00/0.06
600295	9.5" Aria Ladle	12 ea	2.90/0.08
600296	13.5" Aria Ladle	12 ea	3.10/0.10
604460	9.25" Aria Solid Spoon	12 ea	2.60/0.03
604606	6" Aria Salad Tong	12 ea	1.96/0.04
604609	9" Aria Salad Tong	12 ea	3.20/0.07





Buffet Tongs

- Heavy-duty 18-8 stainless steel with mirror polished finish for long lasting use
- Durable sanitary one-piece construction
- Scissor tongs are two-piece satin finish construction
- Dishwasher safe



Prod No	Description	Pack	Cs Wt/Cube
Buffet Tongs			
607680	8" Pastry Tong	12 ea	4.00/0.16
607682	8" Serving Tong	12 ea	3.25/0.17
607683	10.25" Scalloped Serving Tong	12 ea	2.80/0.25
607685	10" Scissors Salad Tong	12 ea	6.30/0.30
607687	9.25" Bread Serving Tong	12 ea	4.00/0.18
607690	5.75" Ice Tong	12 ea	1.50/0.07
607691	7" Ice Tong	12 ea	0.20/0.01
607692	10" Scalloped Bread Serving Tong	12 ea	1.00/0.05
607693	9" Salad Tong	12 ea	3.50/0.19
607695	9.5" Pastry Tong	12 ea	3.00/0.17
607697	11.75" Serving Tong	12 ea	0.60/0.05



ICE SCULPTURES & PUNCH BOWLS

Ice Sculptures

- Quick and easy way to turn any table into a showpiece
- Fill mold with water, freeze (48-72 hours), and cut open the mold
- Features patented EZ-Cut Bead™ and Contracting Cone Base™
- One time use
- Instructions included with every Ice Sculpture



SGR1



SCL1



SSW1



SEA1



SD01



SBA1



SBG1



SFI1

Contracting Cone Base allows for expansion while freezing to eliminate the major cause of cracking and breaking in the freezing process.

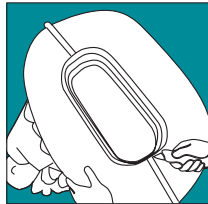

SHR1

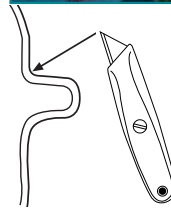

Exclusive EZ-Cut Bead opening system makes it quick and easy to un-mold a work of art.



Illuminated Trays

- Perfect for use at buffets or banquets, or as an accent for ice sculptures
- Light boxes come with Blue, Red, and Yellow colored panels
- Light box is UL listed, fuse protected and operates on 115 volt/60 cycle AC
- Drain kits included



White(02)



Designated(00)

Prod No Description

Color

Pack

Cs Wt/Cube

Ice Sculptures

Prod No	Description	Color	Pack	Cs Wt/Cube
SHR1	Heart: 23.75" L x 14" W x 27.5" H	02	1 ea	9.55/5.36
SGR1	Grecian Bowl: 20.5" L x 23.5" W x 13.5" H	02	1 ea	11.00/6.24
SSW1	Swan: 19" L x 12" W x 21.5" H	02	1 ea	5.90/3.03
SD01	Dolphin: 20.5" L x 14.25" W x 25" H	02	1 ea	9.00/5.38
SBG1	Bride and Groom: 22" L x 14" W x 28" H	02	1 ea	6.03/5.60
SCL1	Clam Shell: 18" L x 12" W x 19" H	02	1 ea	6.50/4.74
SEA1	Eagle: 15.5" L x 24" W x 29" H	02	1 ea	8.00/6.56
SBA1	Basket: 18" L x 12" W x 19" H	02	1 ea	6.60/4.75
SFI1	Fish: 18" L x 12" W x 26" H	02	1 ea	6.70/5.62

Illuminated Trays

SL6011L	Large Light Box (no tray)	00		22.30/2.51
SL6011TC*	Large Smooth Light Box Tray (only)	00	1 ea	16.10/3.21

* Drain Kits are included with Light Box Tray

NOTE: Light Boxes & Trays are sold separately; SGR1, SHR1, SD01, SBG1, SCL1, SEA1, SBA1, and SFI1 can be shipped UPS/FedEx Ground at oversize cost



Pebbled Punch/Serving Bowls

- Pebbled exterior hides scratches
- Break-resistant acrylic
- Safe for use in temperatures from 32° to 160°F



SP18

Punch/Serving Bowls

- Mirror-polished finish exterior and rim, satin finish interior
- Heavy gauge 18-8 stainless steel with argon welded bases for exceptional strength
- Handwashing recommended



609310

609316

Clear(07)

Prod No	Description	Color	Pack	Cs Wt/Cube
Punch/Serving Bowls				
SP18	16 qt, 17.5" Pebbled Punch Bowl	07	1 ea	5.60/2.49
SP22	24 qt, 22" Pebbled Punch Bowl	07	1 ea	8.20/4.30
609310	10 qt, 15.5" Punch/Serving Bowl	—	1 ea	5.50/3.34
609316	16 qt, 18" Punch/Serving Bowl	—	1 ea	8.00/5.02

NSF Listed products are designated with a **Δ** and may be prefixed with an N



BUFFET ACCESSORIES

MirAcryl™ Cubes

- Design allows smaller size cubes to nest inside larger cubes for convenient storage
- Invert to use as ice bucket or wine server
- Light-weight, break-resistant acrylic



MirAcryl Mirrored Display Trays

- Beautiful, durable display pieces are easy to clean
- Made of light-weight acrylic
- Two-sided surface – use Mirrored or solid Black side for display



Mirror Acrylic(23)

Prod No	Description	Color	Pack	Cs Wt/Cube
MirAcryl Cubes				
SMMC8	8" Mirror Cube	23	1 ea	4.20/0.56
SMMC10	10" Mirror Cube	23	1 ea	6.35/0.88
SMMC12	12" Mirror Cube	23	1 ea	13.65/1.42
MirAcryl Mirrored Display Trays				
SMOC24	24" Octagon MirAcryl Tray	23	1 ea	7.35/0.39
SMO1624	24" x 16" Oval MirAcryl Tray	23	1 ea	5.50/0.34
SMO2232	32" x 22" Oval MirAcryl Tray	23	1 ea	9.05/0.64
SMR1624	24" x 16" Rectangle MirAcryl Tray	23	1 ea	6.20/0.34
SMR1836	36" x 18" Rectangle MirAcryl Tray	23	1 ea	10.30/0.99
SMR12	12" Round MirAcryl Tray	23	1 ea	1.75/0.12
SMR16	16" Round MirAcryl Tray	23	1 ea	3.20/0.15
SMR24	24" Round MirAcryl Tray	23	1 ea	7.10/0.34
SMTD16	16" Teardrop MirAcryl Tray	23	1 ea	3.35/0.15
SMTD24	24" Teardrop MirAcryl Tray	23	1 ea	7.10/0.37

NOTE: MirAcryl™ is not returnable if the protective film is removed



Allegro™ Display Stand

- Heavy-weight bases with argon welding for exceptional strength
- Mirror-polished finish
- 18-10 stainless steel
- Handwashing recommended
- May be used as a two tier display stand by not using one upright and one tray



NeWave™ Drip Trays

- Patented NeWave Drip Trays with open, free-flowing design dissipates fluid spills evenly to allow quicker evaporation
- NeWave pattern keeps mug, cup, and pitcher bases dryer by eliminating the common fluid traps on other designs
- Easy to empty and clean
- NSF Listed; dishwasher safe

Octagonal Drip Tray U.S. Patent No. D-418,376;
 Rectangular Drip Tray U.S. Patent No. D-418,377



Black(03)

Prod No	Description	Color	Pack	Cs Wt/Cube
Allegro Display Stand				
609170	Allegro Three Tier Display Stand	—	1 ea	7.00/0.42
NeWave Drip Trays				
11020 Δ	NeWave 4" Square Drip Tray	03	12 ea	1.95/0.15
11030 Δ	NeWave 4" Octagon Drip Tray	03	12 ea	1.70/0.13
11026 Δ	NeWave 6" Square Drip Tray	03	12 ea	4.00/0.30
11036 Δ	NeWave 6" Octagon Drip Tray	03	12 ea	3.40/0.30

NSF Listed products are designated with a Δ and may be prefixed with an N



CARLISLE
FOODSERVICE PRODUCTS



INNOVATIVE GUEST- PLEASING VERSATILE DEPENDABLE **FOOD BARS & CONVENIENCE PRODUCTS**

Carlisle's workhorse portable food bars, innovative Coldmaster line, and industry leading line-up of serving and convenience smallwares are critical dining supplies for your operation. We develop products with the needs of demanding foodservice professionals like you in mind. You can count on Carlisle to factor in food safety, attractive and operationally efficiency, rugged durability, and one stop shop availability.



COLDMASTER®

The Coldmaster solution **eliminates** the **inconvenience** and mess of ice, as well as reduces the potential for bacteria. The Coldmaster solution is **revolutionizing** the food pan category, offering **innovative** solutions and **making work easier**.



Coldmaster® CoolCheck™

- Patent-pending technology allows you to quickly see when temperatures are no longer safe
- Same great features as our standard Coldmaster products with the added element of color-changing technology
- Eliminates the guessing game behind food safety
- Unit holds food safely below 41°F for 6-8 hours*
- Reduces waste by “telling” workers when food temperature is safe
- Eliminates the mess and inconvenience of ice
- FDA approved; dishwasher safe
- Use Coldmaster Lids listed on pages 98
- NSF Listed

*Time will vary based on ambient room temperature

Designed to fit in standard sized food pan templates or food wells



↑
Food
Safe
Temp →

←
Above
Food
Safe
Temp

White(02)

Prod No	Description	Color	Pack	Cs Wt/Cube
Coldmaster CoolCheck				
CM1100C14 Δ	6" Deep Full-size Food Pan	02	1 ea	11.45/1.16
CM1101C14 Δ	6" Deep Half-size Food Pan	02	1 ea	5.40/0.57
CM1102C14 Δ	6" Deep Third-size Food Pan	02	1 ea	4.45/0.39
CM1103C14 Δ	6" Deep Third-size Divided Food Pan	02	1 ea	4.45/0.39
CM1104C14 Δ	6" Deep Sixth-size Food Pan	02	1 ea	2.35/0.22
CM1105C14 Δ	6" Deep High Capacity Sixth-size Food Pan	02	1 ea	2.20/0.26

NSF Listed products are designated with a Δ and may be prefixed with an N





The Coldmaster Solution:

- High-impact ABS plastic holds up to foodservice use
- Exclusive refrigerant gel ensures high performance
Non-toxic gel receives a cold "charge" when frozen overnight, which enables it to keep your food cold throughout the day
- Extra insulation surrounds refrigerant gel for maximum cold retention
- Refrigerant gel is enclosed in a bag; prevents leaks, even if shell is damaged

Coldmaster = Peace of Mind

Coldmaster products are available in a variety of shapes and sizes from food pans to crocks, batter pans to ice cream servers. Coldmaster offers peace of mind while it keeps your food cold and fresh. Enjoy the convenience of Coldmaster, as it allows you to transport and keep food cold, anywhere you need to without messy ice or electricity.

Coldmaster Products Exceed Health Department Requirements

- With one overnight charge in your freezer, each Coldmaster keeps food at or below the ServSafe®* guidelines of 40°F for up to eight hours**

- All Coldmaster products are filled with an exclusive non-toxic refrigerant gel
- Constructed of high-impact ABS plastic
- Dishwasher safe

Coldmaster Products Meet FDA Standards

*ServSafe is a registered trademark of the National Restaurant Association

**Temperature retention is based on crocks being pre-frozen for a minimum of eight hours, then filled directly with pre-chilled foods. Testing was conducted under ambient room temperatures of 76°F.



COLDMASTER®

Standard Food Pans & Lids

- Designed to fit in standard sized food pan templates
- Save time and labor by placing food directly into Coldmaster Standard Pans
- Third-size divided splits into two sixth-size food pans
- NSF Listed



Coldmaster Lids

- Designed to fit Coldmaster Standard Food Pans
- Clear acrylic lid protects against contaminants
- Helps maintain cold temperatures so your food stays fresh longer
- Molded-in handle allows easy removal



Prod No	Description	Color	Pack	Cs Wt/Cube
Coldmaster Standard Food Pans & Lids				
CM1100 Δ	6" Deep Full-size Food Pan	02, 03	1 ea	11.45/1.16
CM1101 Δ	6" Deep Half-size Food Pan	02, 03	1 ea	5.40/0.57
CM1102 Δ	6" Deep Third-size Food Pan	02, 03	1 ea	4.45/0.39
CM1103 Δ	6" Deep Third-size Divided Food Pan	02, 03	1 ea	4.45/0.39
CM1104 Δ	6" Deep Sixth-size Food Pan	02, 03	1 ea	2.35/0.22
CM1105 Δ	6" Deep High Capacity Sixth-size Food Pan	02, 03	1 ea	2.20/0.26
CM1125	Full-size Coldmaster Lid	07	2 ea	3.80/1.20
CM1126	Half-size Coldmaster Lid	07	2 ea	2.37/0.41
CM1127	Third-size Coldmaster Lid	07	2 ea	1.90/0.41
CM1128	Sixth-size Coldmaster Lid	07	2 ea	1.37/0.21

NSF Listed products are designated with a **Δ** and may be prefixed with an N





The **safest and most convenient** way to keep foods held in metal pans cold for **up to 8 hours** during outdoor or off-site events. Coldmaster Coldpans allow your operation to keep **limited-time-offer items** chilled **without having to expand your cold well.**

Coldmaster Coldpans

- Designed with the same capacity as traditional style food pans; will hold DuraPan™ Food Pans (pages 216-217)
- Holds and keeps standard food pans cold
- CM1049 Pan Organizer is a 6" deep full size coldpan designed to hold (9) ninth-size food pans for easy organization
- NSF Listed, dishwasher safe



Pan/Organizer

CM1049



CM1042LP



CM1045

CM1042

CM1046

CM1043



Prod No	Description	Color	Pack	Cs Wt/Cube
Coldmaster Coldpans				
CM1042 Δ	6" Deep Full-size Coldpan (will hold full, third, or half size pans)	02, 03	1 ea	18.85/1.83
CM1040 Δ	4" Deep Full-size Coldpan (will hold full, third, or half size pans)	02	1 ea	11.45/1.15
CM1042LP	Full Size Coldpan Lid (fits CM1040, CM1042 and CM1049)	02	1 ea	3.20/0.43
CM1043 Δ	6" Deep Half-size Long Coldpan (will hold 1 half-long pan)	02	1 ea	12.00/1.14
CM1045 Δ	6" Deep Third-size Coldpan (will hold third, sixth, or ninth size pans)	02	1 ea	8.80/0.75
CM1046 Δ	6" Deep Two-Thirds size Coldpan (will hold two-third or third size pans)	02	1 ea	13.75/1.23
Coldmaster Pan/Organizer				
CM1049	6" Deep Full-size Coldpan with Organizer (does not include food pans)	02	1 ea	20.00/1.83

NSF Listed products are designated with a Δ and may be prefixed with an N



COLDMASTER®

Ice Cream Server & Lid

- Coldmaster technology and benefits (see pages 96-97)
- Accommodates standard 3-gallon ice cream tubs
- FREE, clear polycarbonate lid included with each Coldmaster Ice Cream Server
- Replacement Lids (CM1013) also available

Ice Cream Shroud

- Attractive stainless steel cover offers an upscale appearance



CM1012



CM1012 with 38655 Shroud

Coldcrock

- Same Coldmaster technology and benefits (see pages 96-97)
- Crock holds 2 quarts of salad, dressing, or condiments
- NSF Listed



CM1030



38600R

Coldcrock Accessories

- Use Standard Pump (CM1035) with ketchup, mayonnaise, mustard, or other sauces; can be used with or without insert to provide accurate .5 ounce or 1 ounce portions
- Fixed Nozzle Pump (38600R) dispenses 1 ounce per stroke; flow back design prevents messy dripping
- Maxi Pump (CM1037) dispenses 1 ounce portions of salsa, dressings, and other chunky condiments
- Maxi Pump's long nozzle allows easier dispensing; comes with snap-in nozzle restrictors to help eliminate dripping when dispensing thinner condiments



CM1037

CM1035



CM1033



Prod No	Description	Color	Pack	Cs Wt/Cube
Coldmaster Ice Cream Server, Lid & Shroud				
CM1012 ▲	3 gal Coldmaster Ice Cream Server	02, 03	1 ea	7.25/1.05
CM1013	Lid for Coldmaster Ice Cream Server	07	1 ea	1.50/0.68
38655	Coldmaster Ice Cream Shroud	—	1 ea	9.00/1.27
Coldmaster Coldcrock & Accessories				
CM1030 ▲	2 qt Coldcrock (includes Coaster)	02, 03, 23	1 ea	3.90/0.27
CM1032	Clear Solid Lid	07	2 ea	0.47/0.09
CM1033	Clear Slotted Lid	07	2 ea	0.47/0.09
CM1033P	Clear Pump Lid (use with pumps below)	07	2 ea	0.47/0.09
CM1035	.5 or 1 oz Standard Pump	02	2 ea	0.75/0.10
CM1037	1 oz Maxi Pump includes 2 sizes Nozzle Restrictors	02	2 ea	1.00/0.27
38600R	1 oz Fixed Nozzle Pump	—	1 ea	0.45/0.13

NSF Listed products are designated with a ▲ and may be prefixed with an N



Condiment Bar Organizers

- Condiment organizer available for 3 or 6 qt Coldcrocks
- Organizer is made of sturdy, high-impact plastic
- Textured exterior hides scratches
- Order organizer separately or as a set with crocks, lid and pumps (CM1058)
- Coldcrocks (CM1030) sold separately; see facing page for details



CM1065 with Coldmaster Crocks

CM1050



CM1017

Coldbowl

- Coldmaster technology and benefits (see pages 96-97)
- Keeps food at or below 40°F for up to five hours
- 12 quart capacity is perfect for buffets and food bars
- NSF Listed



Dispenser

- Coldmaster technology & benefits
- Perfect for milk, cream, and other temperature sensitive condiments
- Faucet style dispenser offers better control for dispensing liquids

Replacements parts shown on pages 328-330



Prod No	Description	Color	Pack	Cs Wt/Cube
Coldmaster Condiment Bar Organizers				
CM1058	Crock & Organizer Condiment Set (3-Crock Coldcrock Organizer, and 3 ea Coldmaster Crocks, Pump Lids, and Condiment Pumps)	02	1 set	18.90/2.96
CM1065	6-Crock Coldcrock Organizer (only)	02	1 ea	5.05/1.48
CM1069	3-Crock Coldcrock Organizer (only)	02	1 ea	3.95/1.37
Coldmaster Coldbowl				
CM1050 Δ	12 qt, 18" Coldbowl	02	1 ea	7.55/1.14
Coldmaster Dispenser				
CM1017	5 qt Coldmaster Milk Dispenser & Lid	03	1 ea	6.88/0.88

NSF Listed products are designated with a Δ and may be prefixed with an N

CROCKS

Coordinate with colorful quality crocks from Carlisle. We've got the **durability, beauty, and value** you are looking for in a variety our competitors can't beat. Each style has its own features and benefits so you can **select the crock that best suits your needs.**



Classic

- Thick-walled, heavy-weight design; made of SAN
- Chemical resistance to food acids and dressings
- High-gloss finish is extremely scuff-resistant
- 0°F to 180°F temperature range
- 0.6 quart crock fits inside 1.2 quart crock for smaller portions
- Translucent snap-on lids included
- NSF Listed; dishwasher safe

Poly-Tuf™

- Optimum wall design gives greater break-resistance
- Glossy-finish crocks resist chipping and cracking
- Withstands temperatures from 32°F to 180°F
- Translucent snap-on lids included
- NSF Listed; dishwasher safe



Prod No	Description	Color	Pack	Cs Wt/Cube
Classic Crocks				
0300 Δ	0.6 qt Classic Crock with Lid	03	12 ea	3.55/0.60
0301 Δ	1.2 qt Classic Crock with Lid	01, 02, 03, 06, 07	12 ea	7.30/1.17
0316 Δ	1.5 qt Classic Crock with Lid	01, 03, 06, 07	6 ea	6.00/0.81
0302 Δ	2.7 qt Classic Crock with Lid	01, 02, 03, 06, 07	6 ea	7.10/1.25
0304 Δ	4.0 qt Classic Crock with Lid	03	6 ea	11.30/1.91
Poly-Tuf Crocks				
0341 Δ	1.2 qt Poly-Tuf Crock with Lid	01, 03, 06	12 ea	6.20/1.19
0343 Δ	1.5 qt Poly-Tuf Crock with Lid	01, 03, 06	6 ea	4.05/0.84
0342 Δ	2.7 qt Poly-Tuf Crock with Lid	01, 03, 06	6 ea	5.40/1.30
Replacement Lids For Classic & Poly-Tuf Crocks				
0311 Δ	Lid - 0.6/1.2 qt (fits 0300, 0301, 0341)	30	12 ea	0.60/0.09
0202 Δ	Lid - 1.5/2.7 qt (fits 0302, 0316, 0342, 0343)	30	6 ea	1.26/0.12
0602 Δ	Lid - 4 qt (fits 0304)	30	6 ea	2.00/0.21

NSF Listed products are designated with a **Δ** and may be prefixed with an N



Supreme

- Same features as our Classic Crock, but with a 1.5" deep rim
- Gives a stylish bowl-like appearance when dropped into food bar templates
- 6.5" diameter (under rim) fits most template openings
- Translucent snap-on lids included
- NSF Listed; dishwasher safe



Gourmet

- Unique bowl shaped rim with deep crock base
- Stylish frosted pattern on rim helps hide scratches
- Break-resistant polycarbonate takes heat up to 212°F
- Translucent snap-on lids included
- NSF Listed; dishwasher safe



Classic Crock Condiment Station

- Includes organizer, three clear 2.7 quart Classic Crocks with Standard Pumps and Lids
- Organizer made of durable, scratch-resistant textured ABS plastic
- Holds standard size one gallon condiment or 2.7 quart Classic Crocks



Replacements parts shown on pages 328-330



Prod No	Description	Color	Pack	Cs Wt/Cube
Supreme Crocks				
0365 ▲	1.5 qt Supreme Crock with Lid	03, 07	6 ea	5.30/0.84
0372 ▲	2.7 qt Supreme Crock with Lid	03	6 ea	7.75/1.31
0202 ▲	Replacement Lid - 1.5/2.7 qt (fits 0365, 0372)	30	12 ea	1.26/0.12
Gourmet Crocks				
7039 ▲	Gourmet Crock with Lid	03, 07	6 ea	4.43/0.66
7038 ▲	Replacement Lid	30	12 ea	1.30/0.22
Classic Crock Condiment Station				
0306	3-Crock Condiment Station Kit (includes three clear crocks, pumps, and lids)	00	1 ea	5.85/1.05

NSF Listed products are designated with a ▲ and may be prefixed with an N

COLOR-COORDINATED ACCESSORIES

Carlisle has the **largest selection of color coordinated accessories** to complement our Food Bar, Buffet, and Deli Items. **One-piece construction** makes Carlisle accessories more **durable and easier to clean**. Carlisle offers color-coordinated accessories for every kitchen application from **high heat to portion control**.



FOOD BARS & CONVENIENCE

Tongs

High Temperature Carly® Tongs

- Carries a two-year warranty
- Made of revolutionary plastic material for strength and longevity
- Can be used on high temperature surfaces like steam tables
- Withstands heat up to 300°F
- NSF Listed; dishwasher safe

Clear Carly Tongs

- Break-resistant polycarbonate
- Recommended for temperatures up to 212°F; and dry heat up to 270°F
- NSF Listed; dishwasher safe



Prod No	Description	Color	Pack	Cs Wt/Cube
High Temperature Carly Tongs				
4606 Δ	6" Carly Salad Tong	01, 02, 03, 05, 06	12 ea	1.06/0.13
4609 Δ	9" Carly Salad Tong	01, 02, 03, 05, 06, 08	12 ea	2.30/0.25
4709 Δ	9" Carly Utility Tong	01, 02, 03, 05, 06, 08	12 ea	2.00/0.26
4712 Δ	12" Carly Utility Tong	01, 02, 03, 05, 06	12 ea	2.60/0.26
4806 Δ	6" Carly Pom Tong	01, 03, 06	12 ea	0.85/0.12
Clear Carly Tongs				
4006 Δ	6" Carly Salad Tong	07	12 ea	1.06/0.13
4009 Δ	9" Carly Salad Tong	07	12 ea	2.30/0.25
4109 Δ	9" Carly Utility Tong	07	12 ea	2.00/0.26
4206 Δ	6" Carly Pom Tong	07	12 ea	0.85/0.12

NSF Listed products are designated with a Δ and may be prefixed with an N



Ladles Carly Ladles

- Two-year warranty
- 1 ounce, oval-shaped bowl allows pouring from both sides
- Available in 9.5" and 13.5" lengths
- NSF Listed; dishwasher safe



Standard Ladles

- Two-year warranty
- .75 ounce bowl with spouts on each side for easy pouring
- Available in 10.5" length
- NSF Listed; dishwasher safe



Serving Spoons, Buffet Spoons & Pasta Forks

- Two-year warranty
- Recommended for temperatures up to 212°F
- Withstands dry heat up to 270°F
- Serving Spoons have notch in handle so spoon can rest on edge of food pan
- NSF Listed; dishwasher safe

Salad Spoon

- Large flat edge for easy scooping
- 7.25" handle for easy reach
- Durable SAN material
- NSF Listed; dishwasher safe



Brown(01)	White(02)	Black(03)	Red(05)	Beige(06)	Clear(07)	Forest Green(08)
-----------	-----------	-----------	---------	-----------	-----------	------------------

Prod No	Description	Color	Pack	Cs Wt/Cube
Ladles				
0295 ▲	9.5" Carly Ladle	01, 02, 03, 05, 06, 07	12 ea	1.00/0.12
0296 ▲	13.5" Carly Ladle	03	12 ea	1.25/0.15
0287*	9.5" Carly Ladle (Assorted Imprinted)	03	1 set	0.90/0.12
0240 ▲	10.5" Standard Ladle	03, 07	48 ea	4.70/0.58
0261*	10.5" Standard Ladle (Assorted Imprinted)	03	1 set	1.15/0.23
Spoons & Pasta Fork				
4410 ▲	11" Solid Serving Spoon	02, 03, 05, 06, 07, 08	12 ea	1.40/0.13
4411 ▲	11" Perforated Serving Spoon	03, 07	12 ea	1.39/0.13
4420 ▲	13" Solid Serving Spoon	02, 03, 05, 06, 07	12 ea	1.66/0.17
4421 ▲	13" Perforated Serving Spoon	03	12 ea	1.57/0.17
4430 ▲	15" Solid Serving Spoon	03, 07	12 ea	1.80/0.19
4431 ▲	15" Perforated Serving Spoon	03	12 ea	1.75/0.19
4450 ▲	.25 oz, 8" Solid Buffet Spoon	03, 06, 07	12 ea	0.50/0.05
4460 ▲	.5 oz, 8" Solid Buffet Spoon	01, 02, 03, 05, 06, 07, 08	12 ea	0.55/0.05
4470 ▲	.75 oz, 10" Solid Buffet Spoon	01, 03, 05, 06, 07	12 ea	0.76/0.07
4471 ▲	.75 oz, 10" Perforated Buffet Spoon	01, 03, 06	12 ea	0.70/0.07
4355	9.5" Pasta Fork	03	12 ea	1.10/0.19
509 ▲	11" Salad Spoon	01, 03	48 ea	3.50/0.58

NSF Listed products are designated with a ▲ and may be prefixed with an N
 Note: *Assortment Packs includes one each of Bleu Cheese, Lo-Cal, Italian, House, French, Ranch, Thousand Island, & Caesar, plus four plain Imprinted Ladles: Handle imprinted in white with dressing name

FOOD BARS

The Maximizer Food Bar enables you to **serve food anywhere!** Perfect for use with ColdMaster® Food Pans to keep food **below 40° for up to 8 hours.**

7711

Maximizer™ Food Bar

- 6 foot Maximizer Food Bar offers upscale European styling
- Use with ice or with Coldmaster® Standard Food Pans to keep food at 40°F or below for up to eight hours
- Double-sided, acrylic sneeze guard attaches to post with six screw-in knobs
- Basin and cabinet come assembled (no tools required)
- NSF Listed



Tilting sneeze guard makes it easier to clean and fill food bar and can be used as a service line sandwich bar



Holds six full size food pans (20% more than any other similar system)

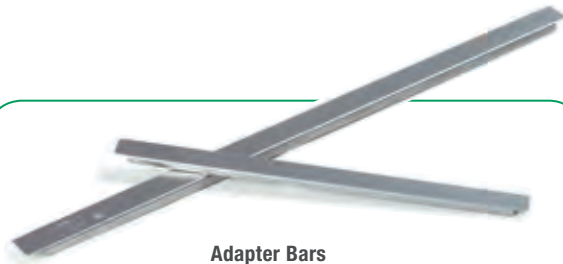

Adapter Bars

Use with various food pans to set up a number of food bar configurations, see page 218 for more information

Maximizer Food Bar Coupon Available
www.carlislefsp.com/ecoupons

Replacements parts shown on pages 328-330

Molded from durable polyethylene and filled with thick polyurethane foam to keep food at correct serving temperatures for hours



Prod No	Description	Color	Pack	Cs Wt/Cube
Maximizer Food Bar & Accessories				
7711 Δ	6 ft Maximizer Food Bar	01, 03, 08, 59	1 ea	320.00/100.06
7721 Δ	6 ft Maximizer Tray Slide	01, 03, 08, 59	1 ea	14.75/1.14
7725 Δ	Maximizer End Shelf	01, 03, 08, 59	1 ea	11.35/0.79

NSF Listed products are designated with a Δ and may be prefixed with an N

FOOD BARS

Features **high-tech coating** to keep the Six Star Food Bar **looking great for years** to come and provides **easy clean up**.

Six★Star™ Food Bars

- Molded with thick polyurethane foam for hours of insulation
- Use with ice or with Coldmaster® Standard Food Pans to keep food at 40°F or below for up to eight hours
- Two-piece acrylic shields allow for easy assembly
- Specially coated finish gives a beautiful glossy sheen and makes clean up easier
- Faucet-type drain plug facilitates water removal
- Add tray slides and end shelves without removing legs
- Sturdy, recessed, 5" non-marking swivel casters, two with brakes
- Easy to assemble
- NSF Listed



6605 with 6620
Tray Slide



6608 with 6621 Tray Slide



6600

Portable Food Bars

- Legs only unit available in 4 or 6 foot models

Youth Bar

Set up a Sundae Station using our Cold Master 3 gallon Ice Cream Server and crocks filled with all the fixins'

- Low 29" serving height is designed for young people to conveniently reach all condiments

Tabletop Bars

Perfect for a Happy Hour Bar!

- Threaded drain plug underneath ice pan for easy water removal

6611 with
6621 Tray Slide
6625 End Shelf





Portable Enclosed Bars

- 6 foot unit with enclosed storage unit and sliding doors

Replacements parts shown on pages 328-330



Prod No	Description	Color	Pack	Cs Wt/Cube
Six★Star Food Bars & Accessories				
6600 Δ	4 ft Six★Star Tabletop	01, 03, 05, 08	1 ea	63.00/12.16
6601 Δ	6 ft Six★Star Tabletop	03	1 ea	92.00/18.01
6605 Δ	4 ft Six★Star Portable with Legs only	01, 03, 08	1 ea	120.00/17.32
6606 Δ	6 ft Six★Star Portable with Legs only	01, 03, 08	1 ea	142.00/27.28
6611 Δ	6 ft Six★Star Portable with Storage & Legs	03, 08	1 ea	170.00/61.68
6608 Δ	6 ft Six★Star Youth with Legs only	03, 05, 08	1 ea	135.00/27.28
6620 Δ	4 ft Six★Star Tray Slide (fits 6605)	01, 03, 08	1 ea	14.10/0.74
6621 Δ	6 ft Six★Star Tray Slide (fits 6606, 6608, 6611)	01, 03, 05, 08	1 ea	14.75/1.13
6625 Δ	Six★Star End Shelf (fits all Six★Star Food Bars)	01, 03, 05, 08	1 ea	11.75/0.66

NSF Listed products are designated with a Δ and may be prefixed with an N

Note: 6621 can ship UPS/FedEx Ground at oversize cost; 6600, 6601, 6608, 6611, 6605, 6606 cannot ship UPS/FedEx Ground

Note: 6600, 6601 tabletop units cannot be converted to portable units

FOOD BARS & ACCESSORIES

Set up a counter top buffet pasta or salad station at your next event.
Perfect for happy hour in the bar!

Five★Star™ Buffet Bars

- Thick polyurethane foam insulation holds ice for hours
- Great with crocks, bowls or icing down beverages
- Drain plug at end of unit
- NSF Listed



7670 with 9720 Sneeze Guard



Sneeze Guards

- Designed to fit Five★Star Buffet Bars
- 9148, 9160, 9172 are NSF Listed



9260



9148

Replacements parts shown on pages 328-330



Prod No	Description	Color	Pack	Cs Wt/Cube
Five★Star Buffet Bars				
7670 Δ	4 ft Five★Star Buffet Bar	01, 03, 08	1 ea	21.10/4.49
7671 Δ	6 ft Five★Star Buffet Bar	01, 03	1 ea	32.83/6.88
Free Standing Single-Sided Sneeze Guards				
9148 Δ	48" Standard Single-Sided	03, 07	1 ea	19.00/3.00
9160 Δ	60" Standard Single-Sided	03, 07	1 ea	24.44/4.33
9172 Δ	73.25" Standard Single-Sided	03, 07	1 ea	27.50/4.65
9224	24" Adjustable Single-Sided	03, 07	1 ea	10.60/1.76
9248	48" Adjustable Single-Sided	03, 07	1 ea	19.25/2.99
9260	60" Adjustable Single-Sided	03, 07	1 ea	25.29/4.33
9272	73.25" Adjustable Single-Sided	03, 07	1 ea	29.05/4.58
Free Standing Double-Sided Sneeze Guards				
9710	48" Standard Double-Sided	03	1 ea	27.30/3.54
9712	73.25" Standard Double-Sided	03	1 ea	40.50/5.20
9720	48" Adjustable Double-Sided	03	1 ea	28.07/3.58
9722	73.25" Adjustable Double-Sided	03	1 ea	40.60/5.46
Sneeze Guard Accessories				
9051	Single End Panel (encloses side area on Single Sneeze Guard)	07	1 pr	2.07/0.27
9052	Double End Panel (encloses side on Double-Sided Sneeze Guard)	07	1 ea	2.10/0.27

NSF Listed products are designated with a Δ and may be prefixed with an N

Sneeze guards not recommended for use with steam tables

Shipping Notes: 7671 cannot be shipped UPS/FedEx Ground; 7670 can ship at oversize cost

9160, 9172, 9260, 9272, 9712 cannot be shipped UPS/FedEx Ground; 9148, 9248, 9710, 9720 can ship at oversize cost





Electric Kettle

- Economical kettle includes 10.5 quart metal inset with hinged lid and ladle
- Thermostatically controlled warmer has low to high temperature settings
- 120 volt/450 watt; 6 foot detachable cord with 3-prong plug; insulating polypropylene shell
- Unit recommended for wet use
- NSF Listed; UL Listed



Pastry Display Cases

- Display pies, cookies, and cakes
- Slide-in trays are textured to resist scratching
- Made of sanitary, easy-to-clean acrylic
- Convenient hinged door with magnetic closure

SPD303KD



Prod No	Description	Color	Pack	Cs Wt/Cube
Electric Kettle				
0588 ▲	Electric Kettle with Inset, Lid & Ladle	03	1 ea	17.19/2.81
Pastry Display Cases				
SPD300	Three Tray (Back Door)	07	1 ea	21.00/5.55
SPD300KD	Three Tray (Back Door) (unassembled)	07	1 ea	25.90/1.91
SPD303	Three Tray, Self Serve Front & Back Door	07	1 ea	21.05/5.25
SPD303KD	Three Tray, Self Serve Front & Back Door (unassembled)	07	1 ea	24.60/1.91
SPD123	Tray Only	07	1 ea	1.90/0.33

NSF Listed products are designated with a ▲ and may be prefixed with an N

Pastry Display Cases listed above can be shipped UPS/FedEx Ground at oversize cost with the exception of SPD123 shipping at standard rate

CONDIMENT SOLUTIONS

Packet Racks

- Packet Racks hold all types of condiment packets, utensils, straws, napkins, and take up very little counter space
- Choose between a sturdy aluminum frame or an economical chrome wire frame
- Durable plastic containers have a drop-in card holder molded into the front
- Unit comes with a set of 31 common label cards for organizing and identifying contents
- For use on counter, or mount to wall with screws (included)



381206LG



381109LG

Food Stations

Condiment Food Station

- 10806 Condiment Station includes (4) sixth-size 6" deep, StorPlus™ polycarbonate black food pans
- Can also hold (4) sixth-size Coldmaster® standard food pans sold separately on page 98

Multi-Purpose Food Station

- 10807 Multi-Purpose Station includes (4) third-size 4" deep, StorPlus™ polycarbonate black food pans
- Can also hold (4) third-size Coldmaster® standard food pans sold separately on page 98



10806

10807

Standard Pump Kit

- 38310 Includes Standard Pump and the following 5 lid sizes: 1.5", 4.31", 4.31"SP, 4.69", and 6.31"
- Pump and lid sets screw or snap on allowing you to pump condiments directly from their containers
- Standard Plastic Pump has 2 restrictor clips for dispensing either .5 or 1 ounce portions



38310

Replacements parts shown on pages 328-330

Black(03)

Prod No	Description	Color	Pack	Cs Wt/Cube
Packet Racks				
381109LG	Aluminum Packet Rack, comes with 9 ea 3.5 qt containers	—	1 ea	12.50/2.74
381206LG	Wire Packet Rack, comes with 6 ea 4 qt containers	—	1 ea	7.50/1.35
Food Stations				
10806	Condiment Food Station (includes 4ea Sixth Size Food Pans)	03	1 ea	13.30/4.54
10807	Multi-Purpose Food Station (includes 4ea Third Size Food Pans)	03	1 ea	16.40/4.45
Standard Pump Kit				
38310	Standard Pump Kit	—	6 ea	2.90/0.39





Carlisle topping rails, made of long lasting stainless steel, are perfect for dispensing condiments, dressings and sauces.

Standard Topping Rails

- Economical Standard Plastic Pump comes with 2 restrictor clips for dispenses either .5 or 1 ounce portions
- Removable pumps and jars included
- Rubber feet protect counter and slipping



Insulated Topping Rails

- Insulated unit combines with reusable ice packs to keep condiments chilled for hours
- Includes reusable ice packs, 2 quart containers, pumps, and self-adhesive labels of most popular condiments
- 2 quart containers include snap-on lids for overnight storage
- Choose between patented* Stainless Steel Pump or economical Standard Pump
- Stainless Steel Pump dispenses 1.25 ounces per stroke; Standard Pump dispenses .5 or 1 ounce portions



High Volume Condiment Pumps

- Holds gallon jars or #10 cans for clean look
- Choose between patented* Stainless Steel Pump or Fixed Nozzle Pump
- Stainless Steel Pump dispenses 1.25 ounce per stroke; Standard Pump dispenses .5 or 1 ounce portions



Prod No	Description	Color	Pack	Cs Wt/Cube
Standard Pump Topping Rails				
38502	Topping Rail with 2 ea Standard Pumps & Jars	—	1 ea	8.05/0.77
38503	Topping Rail with 3 ea Standard Pumps & Jars	—	1 ea	7.50/1.14
38504	Topping Rail with 4 ea Standard Pumps & Jars	—	1 ea	9.65/1.65
Insulated Topping Rails				
386230IB	Insulated Topping Rail with 3 ea Stainless Steel Pumps & 2 Large Ice Packs	—	1 ea	14.95/1.50
386231B	Insulated Topping Rail with 3 ea Standard Pumps & 2 Large Ice Packs	—	1 ea	12.10/0.90
High Volume Condiment Pumps				
386010	High Volume Condiment Pump with Stainless Steel Pump	—	1 ea	6.15/0.80
38601	High Volume Condiment Pump with Fixed Nozzle Pump	—	1 ea	4.65/0.63

*US Patent Nos. 6343720, 6019256, 6450373
Replacement Parts shown on page 328-330

CUP & LID DISPENSERS

Adjustable Cup Dispensers

- One dispenser to fit all standard sizes of foam, paper, or plastic drink cups from 8 to 48 ounces
- Vertical Cabinet Models are made of rugged stainless steel
- Spring-loaded with silicone release gaskets
- Comes with four interchangeable gaskets per tube (small, medium, large, and extra large)
- No tools required; ready to use



38800GLC



38882G

38883G



38884G



38850GEW mounts directly into counter tops or walls (can be inserted into an existing template)



38820C



38830C

Gravity Feed Cup Dispensers

- Adjusts easily to fit various sizes of foam, paper, or plastic cups
- Mounts on walls and includes 2-piece quick-release side mount bracket

Prod No	Description	Color	Pack	Cs Wt/Cube
Adjustable Cup Dispensers				
38882G	2 Cup Dispenser, Vertical Cabinet Model	—	1 ea	20.75/2.58
38883G	3 Cup Dispenser, Vertical Cabinet Model	—	1 ea	30.45/3.90
38884G	4 Cup Dispenser, Vertical Cabinet Model	—	1 ea	39.05/5.05
38850GEW	Cup Dispenser only	—	1 ea	5.10/1.10
Gravity Feed Cup Dispensers				
38820C	Small Cup Dispenser, holds 6-11 oz, 2.5" - 3.44" cups	—	1 ea	2.10/0.20
38830C	Large Cup Dispenser, holds 12-24 oz, 3.38" - 3.88" cups	—	1 ea	2.55/0.25



Lid & Condiment Organizer

- Stainless Steel Organizer mounts on top of Vertical Cup Dispenser Cabinets or can be used on counter tops
- Rubber feet prevent slipping and protect counter
- Includes (2) pint & (3) quart plastic inserts



38800GLC

Counter Top Lid & Straw Dispenser

- Dividers adjust to accommodate all standard size lids
- Straw panel is removable for additional lid storage
- Rubber feet protect counter tops
- Dispenser can be wall mounted on two standard key-lock holes



388804L

6-Compartment Condiment Caddy

- Compact 8" x 14" size fits counter tops and coffee cabinets with limited space
- Stepped design with deep compartments for organizing condiments
- Durable ABS plastic with textured finish hides scratches



10828

Dispensers

- Sliding tops for easy loading

Toothpick Dispenser

- Holds standard box of toothpicks
- Security cable prevents theft

Straw Dispenser

- Holds a full box of regular or jumbo unwrapped straws up to 8.5" long
- Easy turn knob dispenses one straw at a time



TP100

SSD100

Replacements parts shown on pages 328-330



Prod No	Description	Color	Pack	Cs Wt/Cube
Lid & Condiment Organizer				
38800GLC	Lid/Condiment Organizer	—	1 ea	5.30/1.10
Counter Top Lid & Straw Dispenser				
388804L	4 Station Counter Dispenser	—	1 ea	3.30/0.58
6-Compartment Condiment Caddy				
10828	6-Compartment Coffee Service Condiment Caddy	03	12 ea	6.90/1.66
Dispensers				
TP100	Toothpick Dispenser	07	1 ea	0.84/0.07
SSD100	Straw Dispenser	07	1 ea	2.50/0.30

BEVERAGE SERVICE

Perfect for value restaurants and cafeterias!

TrimLine™ Rectangular Beverage Dispensers

- Sleek rectangular design saves valuable counter space
- Quart and liter capacity indicators on both sides
- Reservoir has ergonomic handles for a secure grip
- Features textured lid and base
- Hingeless lid minimizes breakage and helps prevent spills
- Removable Drip Tray prevents spills and saves on clean-up time
- Choose super tough crystal clear polycarbonate or economical translucent polypropylene
- Premium Dispenser has deluxe, no-drip, locking faucet
- Economy Dispenser has industry standard, no-drip faucet
- Includes labels: Fruit Punch, Iced Tea, Lemonade, Sweetened Tea, and Unsweetened Tea



FOOD BARS & CONVENIENCE

Replacements parts shown on pages 328-330



Prod No	Description	Color	Pack	Cs Wt/Cube
TrimLine Single Base – Compact 8" width (Includes 1 ea 3 gal dispenser)				
10850 Δ	3 gal Premium (PC) Single Base	03, 69	1 ea	6.30/2.74
10854 Δ	3 gal Premium (PPY) Single Base	03, 69	1 ea	5.85/2.74
10852 Δ	3 gal Economy (PC) Single Base	03	1 ea	6.30/2.74
10856 Δ	3 gal Economy (PPY) Single Base	03	1 ea	5.85/2.74
TrimLine Double Base – Compact 15.5" width (Includes 2 ea 3 gal dispensers)				
10851 Δ	3 gal Premium (PC) Double Base	03	1 ea	11.50/4.03
10853 Δ	3 gal Economy (PC) Double Base	03	1 ea	11.50/4.82
10857 Δ	3 gal Economy (PPY) Double Base	03	1 ea	10.20/4.82

NSF Listed products are designated with a Δ and may be prefixed with an N

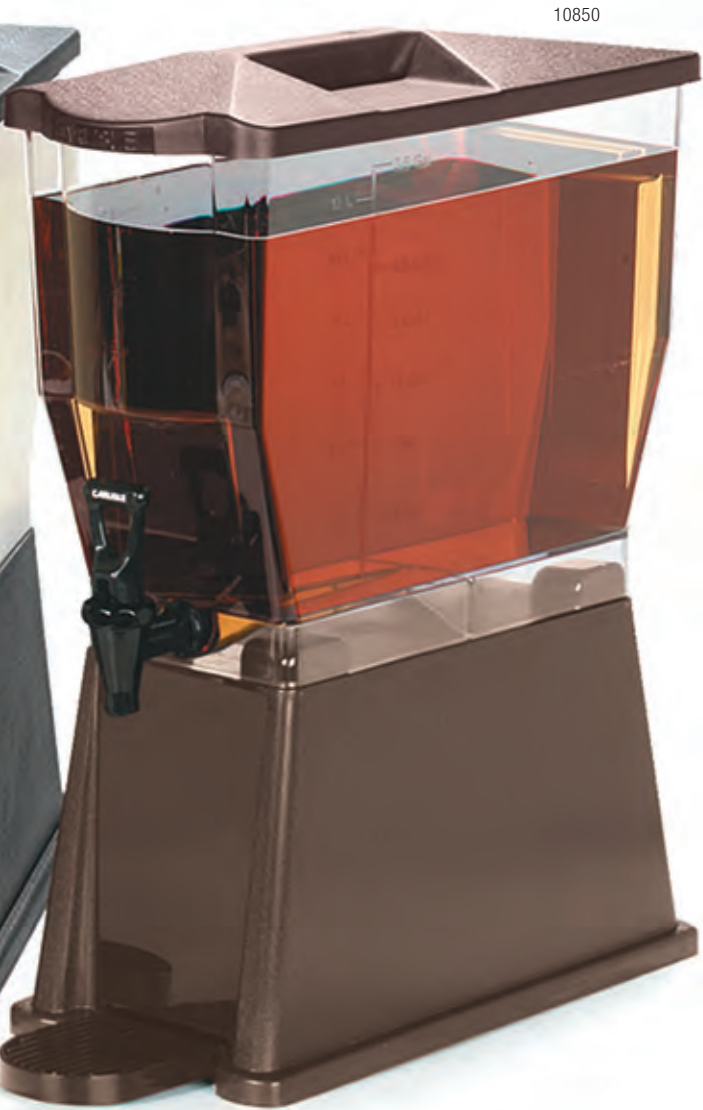

Square Beverage Dispenser

- Spring action faucet provides fast flow and dripless service

Round Beverage Dispensers

- Embossed measuring lines in 1-quart increments
- Dispensers and base sold as a unit or dispenser sold separately
- Includes labels for Iced Tea, Lemonade, Fruit Punch, Sweetened and Unsweetened Tea



Prod No	Description	Color	Pack	Cs Wt/Cube
Square Beverage Dispenser				
10820	3 gal Square (Translucent PPY) Dispenser with Base	03	1 ea	4.65/1.03
Round Beverage Dispensers With Base				
2230	5 gal Round (White PE) Dispenser with Base	01	1 ea	4.65/1.59
2229	5 gal Round (Translucent PPY) Dispenser with Base	01, 03	1 ea	4.70/1.61
2227	3 gal Round (Translucent PPY) Dispenser with Base	01	1 ea	4.25/1.06
Round Beverage Dispensers				
2210	5 gal Round (White PE) Dispenser	02	1 ea	3.45/1.65
2209	5 gal Round (Translucent PPY) Dispenser	30	1 ea	3.45/1.65
2219	3 gal Round (Translucent PPY) Dispenser	30	1 ea	2.65/1.06



CARLISLE
FOODSERVICE PRODUCTS



EFFICIENT STURDY INNOVATIVE SANITARY **BAR SUPPLIES**

Carlisle's extensive line of bar supplies enable your serving team to operate a more efficient and profitable bar operation with consistent quality for your patrons. Our efficient, time-saving Bar Essentials, Store 'N Pour containers, and caddy systems save you time and money.



MAXIMIZER™ PORTABLE BAR

Delight your guests and increase revenue. Maximizer enables you to give your guests the bar service they want and expect. It's great for anything from banquet rooms and hotel lobbies to poolside bars and terrace dining.

Maximizer Portable Bar

- Maximizer offers all the style and features you expect in a premium bar at a very affordable price
- Large 56" serving area keeps condiment caddies within reach without blocking prep area
- Durable solid molded countertop is easy to clean and includes a convenient molded-in bar mat well
- Sturdy 5" non-marking swivel casters with locking brake on each end hold the bar securely in place during use
- 15-gallon ice bin features an integrated drain and water trap
- Ice bin includes a standard dust cover for sanitary storage and transport
- Fully assembled, no tools necessary
- Replacement parts are listed on page 332

Maximizer Cover

- Protective 8 gauge vinyl cover keeps bar clean and dry when not in use
- Double vented back secures with hook and loop tape for a custom fit
- Tape fastening allows easy access to bar storage area without removing cover

See our money saving coupon online at www.carlislefsp.com/ecoupons



7555 Protective vinyl cover keeps bar clean and dry when not in use



Vented back for easy access

Ergonomic 2-step bar and countertop is designed for ease of drink preparation and serving; large surface area keeps condiment caddies within reach without blocking the prep area.



7550





Designed by bartenders, Maximizer Portable Bar's upscale styling fits in any setting to enable profitable, efficient bar offerings that delight your guests with their favorite libations.



Maximizer Portable Bar's upscale styling is at home in any setting



Durable Maximizer Portable Bar is perfect for outdoor service



Built in cutting board for easy condiment preparation; can be removed for thorough cleaning

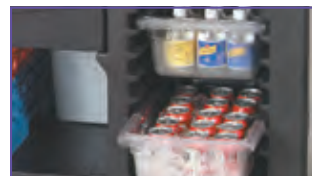

Storage compartment includes molded-in rails; use with StorPlus™ 12" x 18" Food Storage Boxes



Includes standard 22" Stainless Steel Speed-Rak™; holds 6 bottles or 6 Store 'N Pour® Quart containers



Unique sliding storage drawer accommodates mixers, sodas, or standard bus boxes and can be removed for more versatile storage



Large storage area under the drawer is perfect for staging glassware using our OptiClean™ Glass Racks



Prod No	Description	Color	Pack	Cs Wt/Cube
Maximizer Portable Bar & Cover				
7550	Maximizer Portable Bar	03, 44, 094	1 ea	160.00/46.05
7555 ▼	Maximizer Bar Cover	80	1 ea	10.00/0.35

Note: 7550 cannot ship UPS/FedEx Ground

Replacements parts shown on pages 332

WARNING: Products identified on this page with the following ▼ symbol contain chemicals, including one or more phthalates, known to the State of California to cause cancer and birth defects and other reproductive harm.

STORE 'N POUR®

Store 'N Pour

- Enjoy the benefits of the most efficient storing and pouring system for the bar, kitchen, or dining room
- Pour a perfect 2-1 drink every time with the patented vented spout design
- Two-piece spout and neck design for easy cleaning
- Exclusive manufacturing process ensures tight seal with no leaks
- Made of high density, break-resistant polyethylene
- Easy clean containers have straight wall design with no sharp interior edges that can collect food or bacteria
- Unique stacking ridge on quart and pint caps make storage on shelf in refrigerator easy and secure
- Color-coordinated spouts and caps for easy product identification
- Lids snap on exclusive, recessed base of pints and quarts to prevent loss
- Assorted cap colors promote color-coding

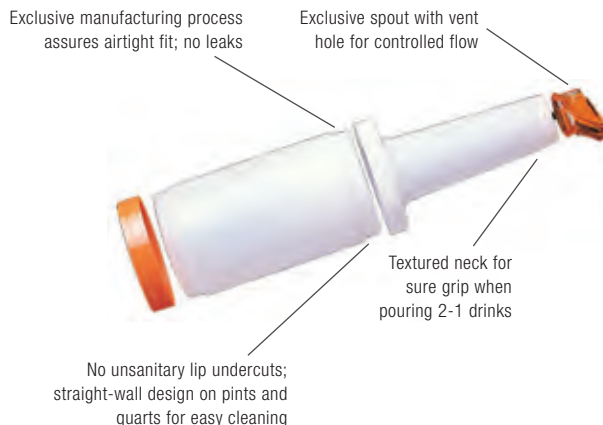

Back of House Store 'N Pour

- Our Store 'N Pour bottles and pourers can also be used in back of the house applications:
- Holding and pouring spices
 - Cooking wine/sherry storage and usage

PourPlus™ PourPlus Complete

- Complete unit includes container, lid, and spout

PourPlus Spout

- PourPlus fits all Store 'N Pour containers
- Integrated neck and spout designed for fast, free flowing pouring and easy clean-up
- Textured neck provides sure grip—even when wet
- Necks are color-coded



Store 'N Pour Versatility



Front-of-the-house use



Perfect 2-1 drinks are easy



Stackable backup storage



Back-of-the-house use



Pour batters and oils

Replacements parts shown on pages 332

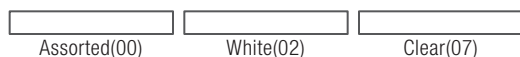

Prod No	Description	Color	Pack	Cs Wt/Cube
Store 'N Pour Speed Spout				
3042	Speed Spout	07	24 ea	0.55/0.05
Pour Plus Store 'N Pour				
PS204	PourPlus Spout	02	12 ea	1.60/0.30
PS204AST*	PourPlus Spout, Assorted	00	1 set	1.60/0.30
PS601NC	Quart Complete	00, 02	12 ea	4.60/0.89

*Assorted PourPlus quart packs include 2 each of all colors; half-gallon and gallon assorted packs includes 1 each of all colors



The Essential Drink Mix System



1. Mix In One-Gallon Container

Accurately measure and mix concentrate or powder in gallon containers. Its wide mouth eliminates the need for a funnel.



2. Cut Preparation Time

Prepare mixes and juices in advance using the gallon storage container. At peak periods simply empty into a quart backup.



3. Transfer To Quarts

Pour a gallon of mix into four easy-to-handle quart containers.



4. Ready To Use

Attach neck with spout to one quart for use in speed rack. Cap the remaining three quarts for backup.

Store 'N Pour Complete Units & Backups

- Complete unit includes neck and container plus color-coordinated pouring spout and cap
- Backup unit includes cap and container
- Dishwasher safe

Store 'N Pour Speed Spout

- No-drip spout is vented to promote faster, more even flow



3042



Store 'N Pour Bar Service Pack

Includes six quart complete units (container, neck, and color-coordinated spout and cap), 18-quart backup units (container and cap) and 1-gallon backup unit (container with cap) for mixing



Assorted(00)	Brown(01)	White(02)	Yellow(04)
Red(05)	Clear(07)	Green(09)	Orange(24)

Prod No	Description	Color	Pack	Cs Wt/Cube
Store 'N Pour Complete Units & Backups				
PS501N	Pint Complete	00	12 ea	3.50/0.88
PS502N	Pint Backup	00	12 ea	1.96/0.64
PS601N	Quart Complete	00, 01, 02, 04, 05, 09, 24	12 ea	4.60/0.89
PS602N	Quart Backup	00, 02, 05	12 ea	3.20/0.82
PS701B	Half-gallon Complete	00	6 ea	2.90/0.90
PS702	Half-gallon Backup	00	6 ea	2.05/0.88
PS801B	Gallon Complete	00	6 ea	4.00/1.87
PS802	Gallon Backup	00	6 ea	3.15/1.84
PS103	Spouts, Specify Color	01, 04, 05, 07, 24	12 ea	0.46/0.05
PS103AT	Spout Assortment, 2 ea color	00	12 ea	1.00/0.05
PS203	Necks	02	12 ea	1.60/0.30
PS304	Caps, Specify Color	01, 02, 04, 05, 24	12 ea	0.70/0.01
PS304AT	Caps, Assortment, 2 ea color	00	12 ea	0.70/0.01
PS603N	Quart, Container Only	02	12 ea	3.00/0.85
Store 'N Pour Bar Service Pack				
PS6012	Store 'N Pour Bar Service Pack	00	1 set	6.95/1.83
Store 'N Pour Speed Spout				
3042	Speed Spout	07	24 ea	0.55/0.05

*Assorted PourPlus quart packs include 2 each of all colors; half-gallon and gallon assorted packs includes 1 each of all colors

BOTTLE HOLDERS & CONDIMENT CADDIES

Stainless Steel Speed-Rak™ Bottle Holders

- Keyhole slots make installation and cleaning easy
- Mounts to bar sink with screws (provided)
- Unique design; single Speed-Raks can be combined to make a double-hung unit



38322BH
Combine to make a
double-hung unit

Replacements parts shown on pages 332

Prod No	Description	Color	Pack	Cs Wt/Cube
Stainless Steel Speed-Rak Bottle Holders				
38322BH	22" Speed-Rak, holds (5) 1-liter bottles	—	2 ea	8.50/1.09
38332BH	32" Speed-Rak, holds (8) 1-liter bottles	—	2 ea	11.75/1.77
38342BH	42" Speed-Rak, holds (10) 1-liter bottles	—	2 ea	12.00/1.79





Condiment Caddies

Stainless Steel Caddies

- Rugged stainless steel construction for years of use
- Full size hinged lid units protect condiments from spills and contaminants
- Individual compartment lids keep contents covered when not in use
- Notched lid models available for use with spoons or ladles
- Sanitary pint & quart inserts are easy to clean; (2) pints interchange with (1) quart, allowing you to mix and match to suit your needs



38704CSIB

Stainless Steel Iced Caddies

- Insulated caddies use ice packs to keep condiments chilled and cold for hours without ice or electricity

Deluxe Caddies

- Solid frosted cover
- Includes caddy and individual containers

Plastic Caddies

- Solid frosted cover
- Includes caddy and individual containers



CH03



SS105



Prod No	Description	Color	Pack	Cs Wt/Cube
Stainless Steel Condiment Caddies				
38704CNS	4 qt Condiment Caddies with 4 Lids	—	1 ea	4.60/0.60
38704CSIB	4 qt Condiment Caddies with 4 Notched Lids & 4 Ice Packs	—	1 ea	8.20/0.80
38704C	4 pt Condiment Caddies with One-Piece Lid	—	1 ea	2.50/0.32
38705C	5 pt Condiment Caddies with One-Piece Lid	—	1 ea	2.85/0.32
38706C	6 pt Condiment Caddies with One-Piece Lid	—	1 ea	3.20/0.32
Plastic Condiment Caddies				
SS105	Caddy with 5 ea 1.25 Pint Containers/Lids	02	1 ea	3.30/0.43
CH03	Deluxe Condiment Caddy with 6 ea Pint Containers	03	1 ea	3.25/0.31
CH15	Deluxe Condiment Caddy with 4 ea 1.5 Pint Containers	03	1 ea	3.25/0.31

BAR ACCESSORIES

Bar Caddy

- Ideal bar-top holder that allows quick access to cocktail napkins, stirrers, and other accessories
- Break-resistant plastic



Store 'N Pour® Condiment System

- Condiment system includes tray with cover and six pint containers (PS502N) with assorted caps
- Assorted color caps provide easy identification; caps snap on the bottom for easy storage
- Acrylic covers protect condiments during service



Black(03)

Prod No	Description	Color	Pack	Cs Wt/Cube
Bar Caddy				
BC05	Bar Caddy	03	12 ea	16.53/1.84
Store 'N Pour Condiment System				
PS101CS	Complete Condiment System	00	2 ea	4.75/0.65





Bar Mat & Service Mat

- Non-slip mats help keep counter tops clean
- Molded-in pattern provides drainage for spilled drinks and wash downs with a sure grip for wet glassware
- Bar Mats have drainage area for jigger, main area holds up to six glasses

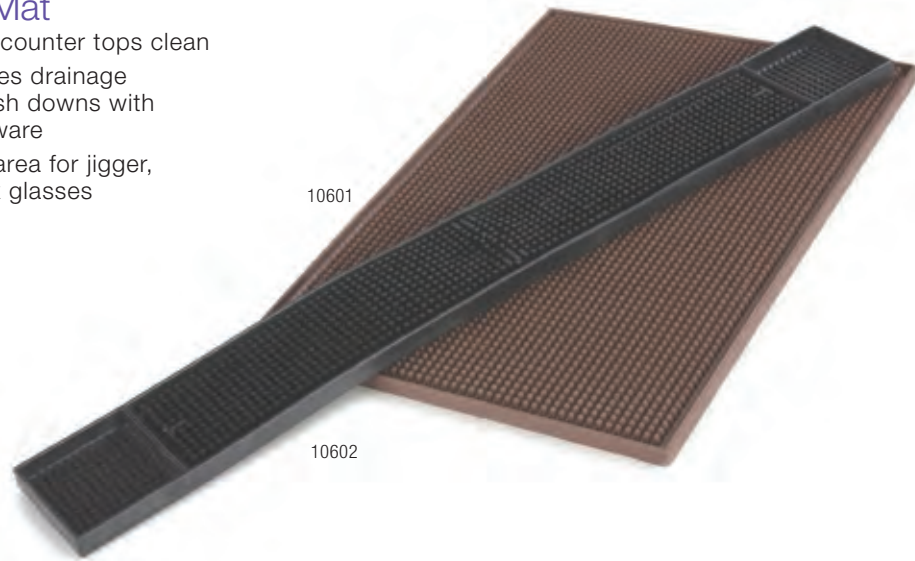

Bar & Shelf Liner

- Provides skid-resistance and high impact absorption; net pattern allows thorough drainage, promoting rapid, fog-free drying
- Helps prevent bacteria growth
- Resistant to food acids, grease, and detergents; conforms to FDA regulations
- Constructed of a firm, resilient plastic

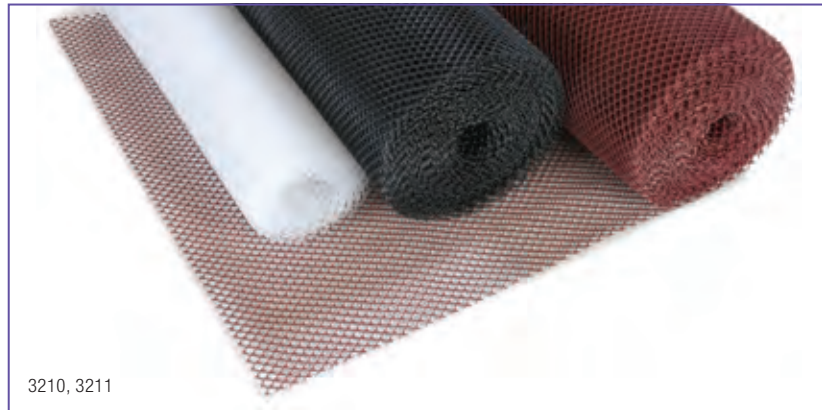

Prod No	Description	Color	Pack	Cs Wt/Cube
Bar Mat & Service Mat				
10601	12" x 18" Service Mat	01, 03	6 ea	9.70/0.69
10602	3" x 27" Bar Mat	01, 03	12 ea	10.00/0.44
Bar & Shelf Liner				
3210	2' x 40' Texliner Roll	01, 03, 07	1 ea	9.50/0.95
3211	2' x 10' Texliner Roll	03, 07	1 ea	2.35/0.45

BAR ACCESSORIES

Glass Rimmers

Standard Glass Rimmer

- Two-tier unit provides consistent and even coat of salt

Combination Salt/Sugar Glass Rimmer

- Three-tier unit allows for application of either salt or sugar



Portion Control Liquor Pourers

- Carlisle offers portion control pourers in both ounce and metric measurements
- Classic design Portion Pour dispenses exact shots of liquor

Portion Pour®

- Portion Pour dispenses exact shots of liquor from 1 to 1.5 ounce
- Also available in 20ml metric size



Standard(00)	Black(03)
--------------	-----------

Prod No	Description	Color	Pack	Cs Wt/Cube
Glass Rimmers				
GR09	3-Tier Glass Rimmer	03	12 ea	15.00/1.07
GR10	2-Tier Glass Rimmer	03	12 ea	16.53/1.84
Portion Control Liquor Pourers With Red Spout/Black Collar				
EP214	1 oz Portion Pour with Red Base	00	12 ea	0.67/0.07
EP215	1.13 oz Portion Pour with Purple Base	00	12 ea	0.67/0.07
EP216	1.25 Portion Pour with Clear Base	00	12 ea	0.67/0.07
EP217	1.5 oz Portion Pour with Yellow Base	00	12 ea	0.67/0.07
Metric Portion Control Liquor Pouter With Red Spout/Black Collar				
EP320	20 ml Portion Pour with Black Base	00	12 ea	0.67/0.07





Pour Free®

- Economical Pour Free for free-flow pouring



OP371, OP304

Free Flowing Metal Liquor Pourers

- Sturdy metal construction and choice of three flow rates
- Chrome plated for attractive appearance and longer life

Pourer With Screen

- Metal style pourer with sanitary screen



Prod No	Description	Color	Pack	Cs Wt/Cube
Pour Free				
OP304	Sparkle Red Pour Free	00	12 ea	0.28/0.07
OP305	Fluorescent Red Pour Free	00	12 ea	0.28/0.07
OP311	Blue Pour Free	00	12 ea	0.28/0.07
OP314	Clear Pour Free	00	12 ea	0.28/0.07
OP316	Black Pour Free	00	12 ea	0.28/0.07
OP371	Chrome/Black Collar Pour Free	00	12 ea	0.28/0.07
OP373	Clear/Black Collar Pour Free	00	12 ea	0.28/0.07
Metal Style Free Flowing Pourers				
WPM25	Chrome Tapered with Screen	38	12 ea	0.35/0.03
WPM85	Chrome Tapered, Medium Flow	38	12 ea	0.35/0.03
WPM20	Chrome Straight, Fast Flow	38	12 ea	0.35/0.03
WPM45	Chrome Angled, Super Fast Flow	38	12 ea	0.35/0.03

BAR ACCESSORIES

Cocktail Shaker

- Bar Essential 18-8 mirror polished all stainless steel classic 3-piece shaker (608600) has a vented pour spout that reduces splashing and spills
- Units fit together snugly for no-mess shaking

608600



Bar Essential™ Bar Accessories Shaker

- Bar Essential 18-8 heavy-duty shaker (608530) features sturdy one-piece construction; ultra smooth interiors won't scratch or chip mix glasses



608530

Bar Spoon

- Heavy-duty bar spoon is perfect for hand mixing drinks
- 18-8 stainless steel won't rust like economy spoons
- NSF Listed; dishwasher safe



608212

Wine Servers & Coolers

Double Walled Wine Coolers

- Double walled construction keeps bottles chilled for hours (no need to pre-chill cooler or use ice)
- Prevents damaging surface condensation
- 18-8 stainless steel is more durable than marble coolers; never requires polishing
- Choose satin or mirror polish finish
- 609144 and 609145 also accommodate champagne bottles
- Hand wash only



609143



609144



609145

Prod No	Description	Color	Pack	Cs Wt/Cube
Cocktail Shakers				
608600	30 oz Classic Cocktail Shaker	—	12 ea	10.00/1.63
Bar Essential Bar Accessories				
608530	30 oz Bar Essentials Bar Cup	—	12 ea	6.00/0.19
608212 Δ	11.25" Heavy-Duty Bar Spoon	—	24 ea	2.65/0.08
Double Walled Wine Servers & Coolers				
609143	Double Wall Wine Cooler, Satin Finish with Mirror Finish Rim; 7.75" H	—	1 ea	1.03/0.12
609144	Double Wall Wine Cooler, Satin Finish with Mirror Finish Rim; 8.75" H	—	1 ea	3.00/0.19
609145	Double Wall Wine Cooler, Mirror Finish, 8.75"H	—	3 ea	8.40/0.73

NSF Listed products are designated with a Δ and may be prefixed with an N





Wine Buckets & Stands

- Wine buckets and stands enhance any fine dining experience
- Choice of standard or double size wine bucket
- Stands are 24" high with heavy, weighted bases to prevent accidental tipping
- 18-8 stainless steel never requires polishing
- Mirror polish finish, hand wash only



609107



609110

609146



609109

609147

Prod No	Description	Color	Pack	Cs Wt/Cube
Wine Buckets & Stands				
609107	Wine Bucket (fits 609146)	—	1 ea	9.40/1.26
609109	Magnum Deluxe Wine Bucket (fits 609147)	—	1 ea	3.00/0.62
609110	Allegro Wine Bucket (fits 609146)	—	1 ea	3.00/0.31
609146	24" Wine Bucket Stand; 7.5" Dia	—	1 ea	11.00/0.65
609147	24" Wine Bucket Stand; 8.5" Dia	—	1 ea	11.00/0.67

NSF Listed products are designated with a Δ and may be prefixed with an N

BAR ACCESSORIES

Wine Server

- Wine Servers merchandise your wine selection
- Double-wall construction provides insulation to help keep wine at proper temperatures



Red Wine Holder

- Satin finish 18-8 stainless steel never requires polishing
- Two rings orbit above the base to create an easy carry handle; bottles snap into handle for secure pouring
- Hand wash only



Acrylic Ice Buckets

- Can also be used for chilling wine
- Diamond Cut Bucket has chrome-plated lid and side handles
- Wine/Ice Bucket has attractive pebbled finish in clear acrylic



Prod No	Description	Color	Pack	Cs Wt/Cube
Acrylic Wine Servers				
IG224	Acrylic Server with Black Base	03	12 ea	18.30/1.92
Red Wine Holder				
609106	Red Wine Holder	—	1 ea	1.30/0.20
Acrylic Ice Buckets				
IG245	Diamond Cut Bucket with Handle	07	6 ea	16.50/2.50
IG1011	Wine/Ice Bucket with Handle	—	4 ea	3.90/0.92





Ice Buckets

- 18-8 stainless steel never requires polishing
- Double walled construction (609190, 609193) holds ice longer and prevents surface condensation
- 609190 has flat handle, hinged lid and comes complete with perforated drain tray and tong
- 609191 has mirror polished finish outside, satin finish inside, with knob handles
- 609193 has tubular handle and satin finish; complete with lid
- Hand wash only



609190



609193



609191

Ice Scoops

- 606106 scoop is made of 18-8 rust-free mirror polished stainless steel
- 4306 is made of durable polycarbonate material for long lasting use
- Tapered for easy pouring of ice into glasses
- Both feature a hole for hanging or tying to a container
- Made of durable polycarbonate material for long-lasting use
- See page 183 for a complete listing of Carlisle's scoop line
- NSF Listed; dishwasher safe



606106

4306



Clear(07)

Prod No	Description	Color	Pack	Cs Wt/Cube
Stainless Steel Ice Buckets				
609190	1.5 qt Double Wall Ice Bucket with Tong	—	1 ea	4.00/0.20
609193	3.5 qt Double Wall Ice Bucket	—	1 ea	2.00/0.35
609191	1.7 qt Ice Bucket with Handle and Tong	—	1 ea	2.00/1.06
Ice Scoops				
606106 Δ	6 oz Stainless Steel Bar Scoop	—	24 ea	5.30/0.19
4306 Δ	6 oz Polycarbonate Scoop	07	12 ea	2.60/0.33

NSF Listed products are designated with a Δ and may be prefixed with an N



PRACTICAL
ELEGANT
RUGGED
DURABLE
**FOODSERVICE
TRAYS**

Carlisle trays and accessories are designed to please your patrons and enable your staff to serve meals economically without sacrificing durability. We set the standard for size, color selection, appearance and reliability.



GLASTEEL™ TRAY COLOR SAMPLES

Solid Colors



AVAILABLE
FOR
IMMEDIATE
SHIPMENT
IN
SELECT
SIZES



Solid Colors (cont.)



054

Mulberry



055

Rainforest Green



066

Mauve



067

Slate Blue



068

Gray



069

Raspberry



076

Coffee Tan



127

Chocolate

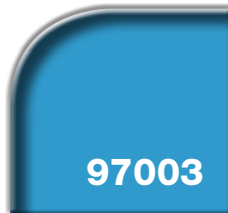

97003

Pacific Blue



97005

Bay Leaf Brown



97030

Cherry Red



97037

Primrose Yellow

Decorative Patterns



028

Starfire Gray



029

Starfire Blue



030

Starfire Natural



031

Starfire Beige

Wood Grain Patterns



063

Pecan



065

Light Oak



092

Butcher Block



094

Redwood

FIBERGLASS TRAYS

Glasteel™ Trays

Glasteel trays offer durability and cleanability at an affordable price.

- Engineered to be the most durable fiberglass trays available
- Decorating option, see page 327 for additional information
- NSF Listed; dishwasher safe

Heavy-Duty Construction

- Metal reinforcing rods provide extra strength and eliminate warping
- Two thick, reinforcing fiberglass core mats add strength and provide increased chemical resistance

Air Flow Corner Reinforcements

- Air flow corner reinforcements and stacking lugs make Glasteel trays your best choice for stability and drying when stacked
- Unique design permits air flow to all surfaces of stacked trays, reducing drying time

Fiberglass Trays are available in full cases only. There is a NO-RETURN POLICY on Fiberglass Trays.



Rectangular Regular & Low-Edge

- Low-edge trays have “squared-off” corners to permit dish overhang, fitting more serving items on a given tray size

Display/Bakery

- Ideal for displays and available in all colors and patterns

Trapezoid

- Space saving shape for better table fit

Euronorm/Metric Trays

- Accommodates Euronorm foodservice dimension standards



Glasteel Fiberglass Tray 5 Year Warranty

Carlisle FoodService Products warrants all of our Glasteel Fiberglass Trays for 5 years from the date of original purchase against breakage arising from normal use and service.



FREE LABELING PROGRAM

Carlisle offers a free decorating program so you can label your trays with a logo or any other call out.

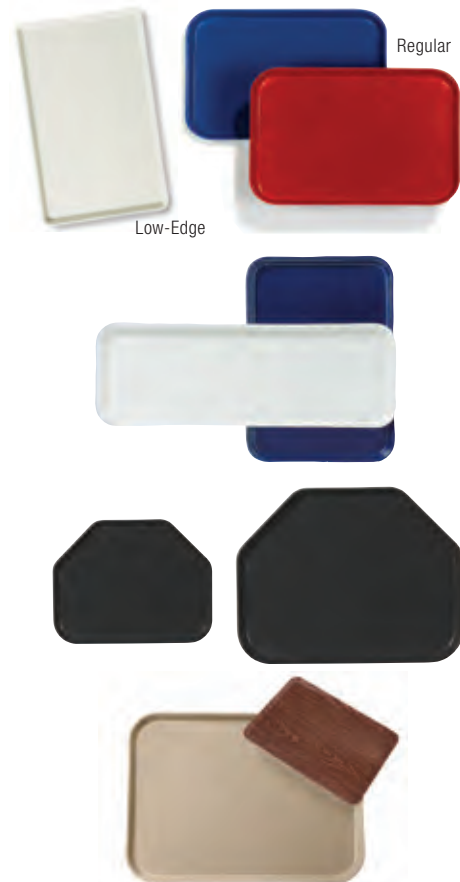



Dimensions & Weights For Use With Self-Leveling Dispensers

Prod No	Length	Width	Height of One	Height of 11	Weight of 10
1410FG	13-3/4"	10-5/8"	3/4"	3-5/16"	9lb 2oz
1612FG	16-3/8"	12"	3/4"	3-5/16"	11lb 12oz
1814FG	18"	14"	3/4"	3-1/2"	14lb 4oz
2015FG	20-1/4"	15"	3/4"	3-5/16"	17lb
2216FG	22"	16"	1-1/8"	4-1/8"	21lb 8oz
1713FG	18"	14"	3/4"	3-1/2"	14lb 12oz
2214FG	22"	14"	3/4"	3-5/16"	15lb 2oz

Trapezoid Tray Table Planner

	1713	2214
36" Square Table Holds	4 ea	4 ea
42" Round Table Holds	4 ea	4 ea
54" Square Table Holds	6 ea	6 ea

Prod No	Description	Pack	Cs Wt/Cube
Solid Color	Decorative Pattern	Wood Grain	
Rectangular			
1410FG Δ	1410DFG Δ	1410WFG Δ	13.75/10.62/0.75 12 ea 11.00/0.46
1612FG Δ	1612DFG Δ	1612WFG Δ	16.37/12.00/0.75 12 ea 16.00/0.55
1814FG Δ	1814DFG Δ	1814WFG Δ	18.00/14.00/0.75 12 ea 19.36/0.59
2015FG Δ	2015DFG Δ	2015WFG Δ	20.25/15.00/0.75 12 ea 23.00/0.82
2216FGQ Δ	2216DFGQ Δ	2216WFGQ Δ	22.12/16.00/1.05 6 ea 12.50/1.01
Low Edge			
1216LFG Δ	1216LDFG Δ	1216LWFG Δ	16.37/12.00/0.62 12 ea 16.00/0.55
1418LFG Δ	1418LDFG Δ	1418LWFG Δ	18.00/14.00/0.62 12 ea 19.90/0.59
1219LFG Δ	1219LDFG Δ	1219LWFG Δ	19.00/12.00/0.62 12 ea 16.40/0.63
1520LFG Δ	1520LDFG Δ	1520LWFG Δ	20.25/15.00/0.62 12 ea 23.00/0.79
1222LFG Δ	1222LDFG Δ	1222LWFG Δ	21.06/12.06/0.80 12 ea 21.00/0.76
Display/Bakery			
269FG Δ	269DFG Δ	269WFG Δ	8.75/25.50/1.12 12 ea 17.00/0.81
1318FG Δ	1318DFG Δ		17.75/12.75/1.00 12 ea 17.00/0.64
2618FGQ Δ	2618DFGQ Δ	2618WFGQ Δ	17.87/25.62/1.25 6 ea 18.73/1.65
Trapezoid			
1713FG Δ	1713DFG Δ	1713WFG Δ	18.00/14.00/0.85 12 ea 18.25/0.66
2214FG Δ	2214DFG Δ	2214WFG Δ	22.00/14.06/0.88 12 ea 22.00/0.85
Euronorm			
3753FG Δ	3753DFG Δ	3753WFG Δ	530mm/370mm/19mm 12 ea 22.00/0.78
4523FG Δ	4523DFG Δ	4523WFG Δ	450mm/320mm/17mm 12 ea 17.00/0.64
2637FG Δ	2637DFG Δ	2637WFG Δ	370mm/265mm/19mm 12 ea 12.30/0.39
1826FG Δ	1826DFG Δ	1826WFG Δ	260mm/180mm/19mm 12 ea 7.90/0.27
Metric			
2310FG Δ	2310DFG Δ	2310WFG Δ	589mm/238mm/16mm 12 ea 19.00/0.63
1220FG Δ	1220DFG Δ	1220WFG Δ	530mm/325mm/16mm 12 ea 21.00/0.66
1212FG Δ		1212WFG Δ	325mm/265mm/16mm 12 ea 10.00/0.33
2115FG Δ	2115DFG Δ	2115WFG Δ	530mm/375mm/16mm 12 ea 24.00/0.76
1419FG Δ	1419DFG Δ	1419WFG Δ	500mm/385mm/16mm 12 ea 23.00/0.80

Available for immediate shipment in Bone White(001), Natural(003), Black(004), & Almond(095)

NSF Listed products are designated with a Δ and may be prefixed with an N
See corresponding covers on page 144

SPECIALTY TRAYS

Carlisle offers a **broad assortment** of shapes, and colors to ensure all your tray needs are met.

Fiberglass Market Trays & Pans

- Use for displaying breads, bakery items, and sliced deli meat
- 2" deep pans for serving deli salads, pasta, and desserts
- Trays have heavy-duty fiberglass construction and metal reinforced rods
- Air-flow corners reduce drying time
- NSF Listed

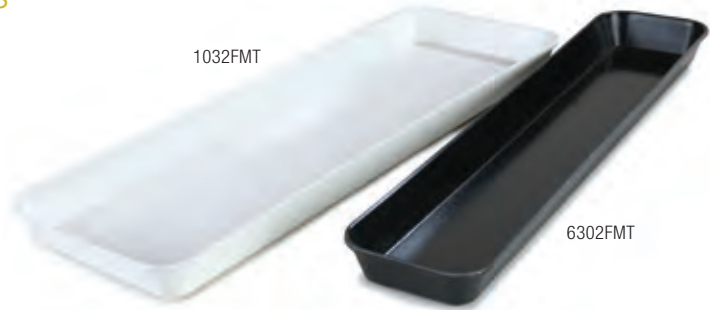

Polycarbonate Tray

- Designed for use in correctional facilities, schools, and other demanding foodservice applications
- Will not break or shatter and have a textured, scratch-resistant finish
- Five-year warranty against breakage saves you money
- They provide rigidity and durability without metal reinforcement rods
- Resistant to food acids and oils and safe for use in temperatures of -40°F to 212°F
- NSF Listed; dishwasher safe



Polycarbonate Tray 5 Year Warranty

Carlisle FoodService Products warrants all of our Polycarbonate Trays for 5 years from the date of original purchase against breakage arising from normal use and service.

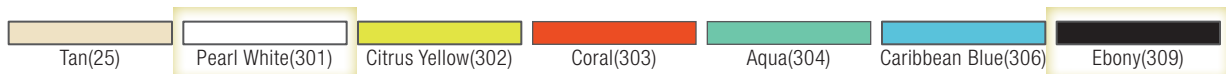

Prod No	Description	Color	Pack	Cs Wt/Cube
Fiberglass Market Trays				
630FMT Δ	30.00/6.44/0.75	309*	12 ea	16.40/0.63
830FMT Δ	30.00/8.50/0.75 Tray	301, 309	12 ea	20.00/0.82
1030FMT Δ	30.00/10.44/0.75 Tray	301, 309	12 ea	24.90/1.01
1230FMT Δ	30.00/12.44/1.05 Tray	301, 309	12 ea	27.00/1.13
269FMT Δ	8.75/25.50/1.12 Tray	301, 309	12 ea	19.75/0.81
1218FMT Δ	17.75/11.44/0.75 Tray	301, 309	12 ea	14.26/0.64
1318FMT Δ	17.75/12.75/1.00 Tray	301, 309	12 ea	19.50/0.64
2618FMTQ Δ	17.87/25.62/1.25 Tray	301, 302, 303, 304, 306, 309	6 ea	20.25/0.81
Fiberglass Market Pans				
6302FMT Δ	30.00/6.45/2.00 Pan	301, 309	12 ea	20.50/0.75
8302FMT Δ	30.00/8.45/2.00 Pan	301, 309	12 ea	25.25/0.90
10302FMT Δ	30.00/10.47/2.00 Pan	301, 309	12 ea	29.20/1.20
Polycarbonate Trays				
1418PC Δ	18.00/14.00/1.13 Rectangular Tray	25	12 ea	16.15/0.71

Available for immediate shipment—all other colors available as special order

NSF Listed products are designated with a Δ and may be prefixed with an N





Café Trays

- Feature skid-resistant surface and drying/stacking lugs
- Custom hot stamping is available, see page 323 for additional information
- Economical & light-weight polypropylene
- NSF Listed



Standard Café Tray

- Traditional scratch-resistant basket weave design reduces slipping and helps prevent accidental spills

Trapezoid Café Tray

- Space saving shape allows diners to eat directly from trays without removing plates, cups, etc. from the tray
- Promotes self-bussing



Handled Café Tray

- Handled tray is easy to carry and offers added strength

Carlisle recommends hand washing for Café Trays

Bistro™ Trays

- Unique trays offer a great look at an economical price
- Durability and economy of our Café Trays with stylish curved handles for easy handling and added strength
- Scratch-resistant, textured design reduces slipping, helps prevent spills
- Drying and stacking lugs

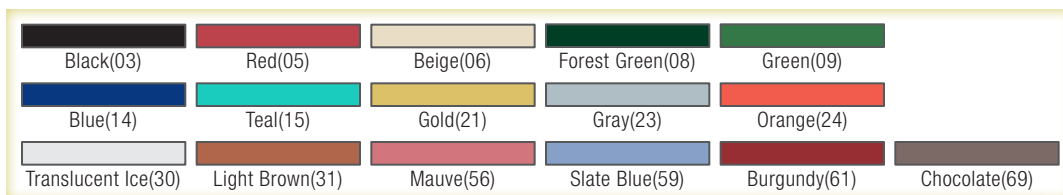
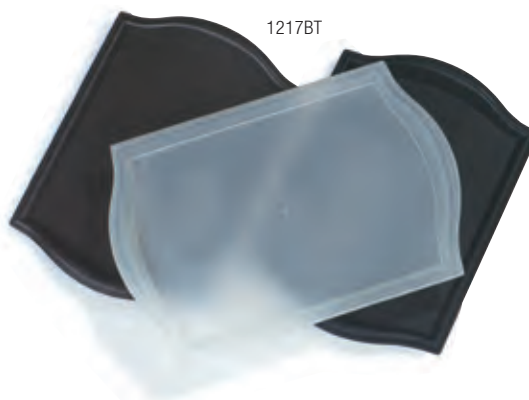

Prod No	Description	Color	Pack	Cs Wt/Cube
Café Trays				
CT1014 Δ	13.87/10.75/0.79 Standard Tray	03, 05, 06, 08, 09, 14, 15, 23, 24, 61, 69	24 ea	10.95/0.52
CT1216 Δ	16.31/12.06/0.70 Standard Tray	03, 05, 06, 08, 09, 14, 15, 21, 23, 24, 31, 59, 61, 69	24 ea	19.00/0.80
CT1418 Δ	17.87/14.00/0.98 Standard Tray	03, 05, 06, 08, 09, 14, 15, 23, 24, 31, 59, 61, 69	12 ea	12.50/0.61
CT1713TR Δ	18.00/14.00/0.81 Trapezoid Tray	03, 06, 14, 23, 69	12 ea	11.26/0.57
CT1217 Δ	16.93/12.06/0.60 Handled Tray	03, 05, 14, 69	24 ea	19.10/1.08
Bistro Trays				
1217BT	12" x 17" Bistro Tray	03, 30	12 ea	11.02/0.73
1319BT	13" x 19" Bistro Tray	03, 30	12 ea	13.01/0.64

Available for immediate shipment

NSF Listed products are designated with a Δ and may be prefixed with an N

COMPARTMENT TRAYS

Our Compartment Trays are the perfect **cost effective solution** for portion control.

6-Compartment Trays

- The 6-compartment trays hold government "Type A" lunch
- Carlisle offers the largest variety of sizes and compartment combinations available
- All materials are FDA approved and NSF Listed



Materials

Melamine

- Melamine is a heavy, rigid material with the look and feel of china
- It is very scratch- and break-resistant
- Fast drying melamine is highly resistant to chemicals and food acids with a temperature range of 0° to 212°F

Polycarbonate

- Money saving trays carry a five-year warranty against breakage
- Highly break-resistant; perfect choice for correctional facilities
- Polycarbonate offers good scratch- and chemical-resistance with a temperature range of -40° to 212°F

Polypropylene

- Economical, durable choice
- Good chemical resistance
- Temperature range of 30° to 180°F
- Handwashing is recommended

ABS

- Break- & scratch-resistant
- Excellent choice for general use
- Highly resistant to chemicals and food acids with a temperature range of 0° to 180°F

Orientations

Left & Right-Hand

- Offer a greater variety of serving combinations
- Available in melamine, polycarbonate, ABS, and polypropylene
- NSF Listed, except when offered in Variegated(00)

Omni-Directional & Space Saver Trays

- Special design allows you to fit two trays side by side in dish rack for faster cycling time



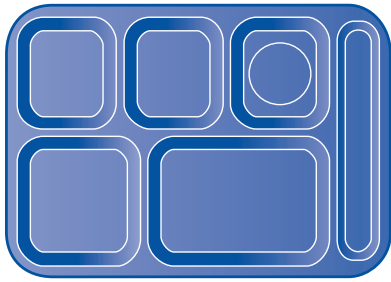

Right-Hand Tray
(43988, 43989, 614R, P614R)



Space-Saver Omni-Directional Tray
(615**)

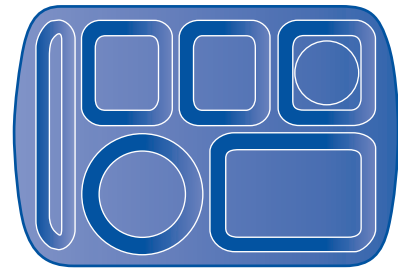

Handled Economy Left-Hand Tray
(5865)

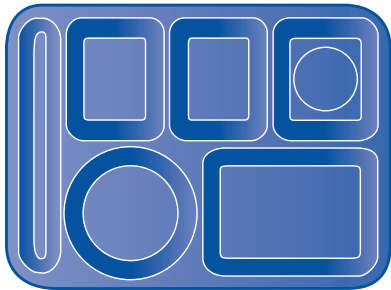

Left-Hand Tray
(43980, 43981, 614, P614, 614PC†)

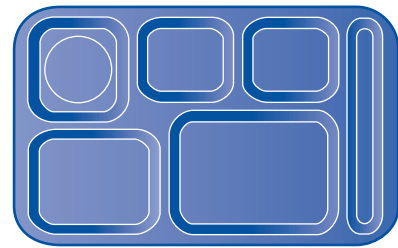

Space-Saver Right-Hand Tray
(43982, 43983)

Variegated(00)*	White(02)	Black(03)	Yellow(04)	Red(05)	Forest Green(08)
Green(09)	Blue(14)	Tan(25)	Bright Yellow(34)	Cafe Blue(35)	Dark Blue(50)
Slate Blue(59)	Mint Green(64)	Dark Cranberry(85)	Purple(87)	Sandshades(92)	Rose Granite(93)

Prod No	Description	Color	Pack	Cs Wt/Cube
Right-Hand Trays				
43988 Δ	Heavy-weight Melamine Tray	02, 05, 08, 25, 34, 35, 50, 59, 64, 85, 87	12 ea	16.10/0.73
43989 Δ	Heavy-weight Sandshades/ Rose Granite Melamine	00*, 92, 93	12 ea	14.00/0.68
614R	ABS Tray	03, 05, 09, 25, 59	24 ea	20.21/1.05
P614R	Polypropylene Tray	05, 09, 14, 25	24 ea	16.75/1.01
Space-Saver Right-Hand Tray				
43982 Δ	Space-Saver Melamine Tray	05, 08, 50, 59	12 ea	17.35/0.77
43983 Δ	Space-Saver Sandshades Melamine Tray	92	12 ea	17.75/0.78
Left-Hand Trays				
43980 Δ	Heavy-weight Melamine Tray	04, 05, 08, 25, 35, 50, 59, 64, 85, 87	12 ea	13.95/0.58
43981 Δ	Heavy-weight Sandshades/Rose Granite Melamine	00*, 92, 93	12 ea	14.10/0.58
614PC †	Polycarbonate Tray	25	24 ea	19.39/0.60
614	ABS Tray	03	24 ea	16.85/0.60
P614	Polypropylene Tray	05, 25	24 ea	12.19/0.60
Handled Economy Melamine Left-Hand Tray				
5865	Handled Economy Melamine Tray, Variegated	00*	12 ea	11.65/0.33
Space-Saver Omni-Directional Tray				
615**	Space-Saver ABS Tray	03, 05, 14, 25	24 ea	16.80/0.94

NSF Listed products are designated with a Δ and may be prefixed with an N

*Note: Variegated(00) option is not NSF Listed

**615 is a licensed product under U.S. Patent D292, 768

† 614PC carries a 5-year warranty against breakage

Rose Granite, Sandshades, and Variegated items vary in color, hue, and intensity from piece to piece



TRAYS, COVERS & ACCESSORIES

Polycarbonate Compartment Trays

5-Compartment Trays

- 5-year warranty against breakage
- Inside compartments have a textured surface for greater scratch resistance
- NSF Listed; dishwasher safe



Polycarbonate Tray 5 Year Warranty

Carlisle FoodService Products warrants all of our Polycarbonate Trays for 5 years from the date of original purchase against breakage arising from normal use and service.

4-Compartment Trays

- Smaller size trays are perfect for elementary schools and lunch menus
- Omni-directional KL444 and 43986 trays feature two-way stacking
- NSF Listed; dishwasher safe



PCD801



43986

43986



43984

KL444

Compartment Tray Cover

- Help maintain food temperatures and protect food from contamination and spills
- Dishwasher safe

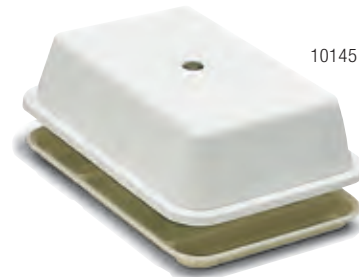

10145

Pastry Tray Covers

- Clear covers offer best visibility in bakeries, delis, and convenience stores
- Sanitary covers help preserve taste and quality
- Rust-proof stainless steel hinges and screws provide long life
- Use with Carlisle trays, see pages 138-139 for corresponding trays

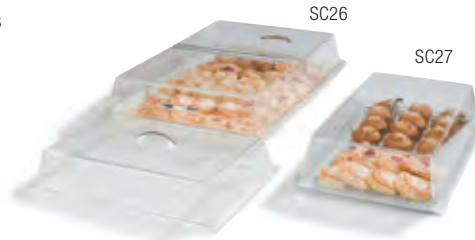

SC26

SC27

Carlisle Tray Guide

SC25 & SC26 fit 2618FG, 2618DFG, 2618WFG trays

SC27 & SC29 fit 1220FG, 1220DFG, 1220WFG trays

SC40 fits 1318FG, 1318DFG, 1318WFG trays

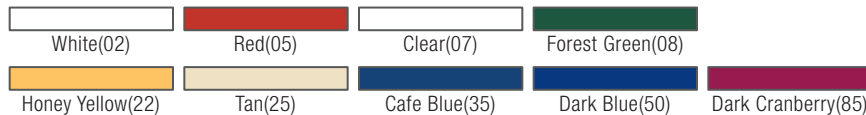

Prod No	Description	Color	Pack	Cs Wt/Cube
5-Compartment Trays				
PCD801 Δ	5-Compartment Tray, 11.50/10.50/1.00	25	24 ea	21.05/0.63
4-Compartment Trays				
43984 Δ	4-Compartment Tray, Right-Hand, 10.11/9.79/0.51	05, 22, 50	48 ea	36.53/1.60
43986 Δ	4-Compartment Server Tray, 10.30/9.58/0.85	25, 35	36 ea	28.50/1.09
KL444 Δ	4-Compartment Tray, 10.95/8.67/0.62	08, 85	12 ea	8.95/0.36
Compartment Tray Cover				
10145	Cover Fits Non-Handled Right and Left Handed 6-Compartment Trays	02	12 ea	11.20/0.80
Pastry Tray Covers				
SC25	26" x 18" x 4" Cover	07	1 ea	6.65/1.76
SC26	26" x 18" x 4" Hinged Cover	07	1 ea	6.85/1.77
SC27	20" x 12" x 4" Cover	07	3 ea	9.90/1.93
SC29	20" x 12" x 4" Hinged Cover	07	3 ea	9.85/1.91
SC40	18" x 13" x 4" Cover	07	1 ea	3.80/1.60

NSF Listed products are designated with a Δ and may be prefixed with an N



Room Service Trays

- 15" x 20" handled room service trays give an upscale dining experience
- Low rimmed edge keeps tray top items in place
- NSF Listed; dishwasher safe
- Available with both a standard and non-skid surface



**NEW
PRODUCT**



RST1520NS

Non-skid trays help minimize spills

Tip Trays

- Standard Tip Tray and Check Holder are made of styrene
- Check Holder's handy clip keeps checks, credit cards, or cash securely in place
- NSF Listed; dishwasher safe



Money Maid™ Combo Packs

- Contains a locking coin and bill compartment, napkin holder, and utility pocket; designed to clip onto trays; see our line of Griptite, GripLite and Cork Trays shown on pages 146-147
- Combo Packs include one Money Maid and six coin trays in a shrink-wrapped set
- Round Clip-On (1401) fits all standard 14" round trays
- Rectangular Clip-On (1030) and Coin Trays fit all 12" x 16" trays



Prod No	Description	Color	Pack	Cs Wt/Cube
Foodservice Room Service Trays				
RST1520 Δ	15" x 20" Low Profile Room Service Tray	03	12 ea	27.75/1.80
RST1520NS Δ	15" x 20" Non-Skid* Low Profile Room Service Tray	03	12 ea	27.75/1.80
Tip Trays				
3022 Δ	Standard Tip Tray; 4.5" x 6.5"	01, 03	36 ea	4.72/0.18
3020 Δ	Check Holder Tip Tray; 4.38" x 7.75"	03	12 ea	1.80/0.14
Money Maid Combo Packs				
1401	Round Clip-On Money Maid	01	12 ea	5.94/0.77
1031	Round Money Maid Combo Pack with Six Coin Trays	01	12 ea	8.19/0.85
1030	Rectangular Money Maid Combo Pack with Six Coin Trays	01	12 ea	7.37/0.64

NSF Listed products are designated with a Δ and may be prefixed with an N

SERVICE TRAYS

Griptite™ Fiberglass

- Heavy-duty fiberglass construction eliminates warping or breakage
- Rubber liner prevents slipping and sliding of glassware and dinnerware
- Rubber liner is permanently bonded to the tray and covers side wall and tray top to provide extra grip
- The 31" oval size helps reduce labor costs by serving an entire banquet table of eight with just one tray
- Trays are stain and odor resistant
- NSF Listed; dishwasher safe



Griptite Tray 5 Year Warranty

Carlisle FoodService Products will replace, at no charge, any Griptite Tray that does not last 5 years from the date of purchase under normal foodservice conditions.

FOODSERVICE TRAYS



Prod No	Description	Color	Pack	Cs Wt/Cube
Griptite Trays				
1100GR Δ	11.00/0.76 Round Tray	004, 076	12 ea	9.00/0.35
1400GR Δ	14.00/0.76 Round Tray	004, 076	12 ea	15.80/0.62
1600GR Δ	16.00/0.73 Round Tray	004, 076	12 ea	20.00/0.72
2500GR Δ	24.00/19.25/1.18 Oval Tray	004, 076	6 ea	20.50/0.82
2700GR Δ	27.06/22.31/1.15 Oval Tray	004, 076	6 ea	25.30/1.13
3100GR Δ	31.5/23.5/1.15 Oval Tray	004, 076	6 ea	33.00/1.43
1410GR Δ	13.81/10.62/0.84 Rectangular Tray	004	12 ea	13.00/0.46
1612GR Δ	16.37/12.00/0.75 Rectangular Tray	004	12 ea	19.75/0.55
1814GR Δ	18.00/14.00/0.84 Rectangular Tray	004, 076	12 ea	24.60/0.59
3253GR Δ	20.87/12.75/1.18 Gastronorm Tray	004	12 ea	28.00/0.80
2015GR Δ	20.25/15.00/1.18 Rectangular Tray	004, 076	12 ea	29.10/0.82
2216GRQ Δ	22.00/16.00/1.18 Rectangular Tray	004, 076	6 ea	17.52/0.50
1826GRQ Δ	25.75/18.00/1.18 Rectangular Tray	004	6 ea	22.85/1.64

Available for immediate shipment

NSF Listed products are designated with a Δ and may be prefixed with an N



GripLite® Polypropylene

- Economical alternative
- Made of a high density polypropylene co-polymer
- Molded-in, rubber liner prevents slipping and sliding of glasses and dinnerware
- A more sanitary alternative to cork trays
- Stain and odor resistant
- Handwashing is recommended



Cork Trays

- Durable plastic construction will not chip or dent
- Available in economical, lightweight, break-resistant polypropylene for bar service or break-resistant, sturdy ABS for heavy-duty use and greater stability
- The cork surface is bonded to the tray and treated to reduce wear and increase durability
- Replacement cork available on page 332
- Handwashing is recommended



Prod No	Description	Color	Pack	Cs Wt/Cube
GripLite Trays				
1100GL	11.25/0.76 Round Tray	004, 076	12 ea	7.30/0.31
1400GL	14.63/0.76 Round Tray	004, 076	12 ea	12.96/0.62
1600GL	16.44/0.73 Round Tray	004, 076	12 ea	20.00/0.72
Cork Trays				
3014	14.00/0.75 Round Tray	01	12 ea	12.00/0.53
3016	16.00/0.75 Round Tray	01	12 ea	15.89/0.67
2419	24.00/19.00/0.75 Oval Tray	01	6 ea	16.82/0.98
2823	28.00/23.00/0.75 Oval Tray	01	6 ea	23.00/1.32
3013	13.88/0.75 Round Tray	01	12 ea	9.20/0.57
3015	15.88/0.75 Round Tray	01	12 ea	13.60/0.62

Available for immediate shipment

NSF Listed products are designated with a Δ and may be prefixed with an N



SERVING TRAYS

Celebration Trays

- Large trays are perfect for serving bread, cheeses, hors d'oeuvres, and pastries
- Economically priced trays are perfect for off site catering or buffet displays
- Sturdy and reusable, they are the perfect alternative to disposables
- Chrome-plated, mirror-polished finish never requires polishing
- Hand wash only; polish dry with soft cloth

Round



Oval



Rectangular



Octagonal



Prod No	Description	Pack	Cs Wt/Cube
Celebration Trays			
608905	13" Round Gadroon Tray	12 ea	9.00/0.22
608907	14" Round Gadroon Tray	12 ea	11.00/0.25
608919	20.88" x 13.5" Oval Tray with Integral Handles	12 ea	24.00/0.43
608904	17.75" x 12.88" Oval Tray with Ornate Border	12 ea	15.00/0.25
608913	17.75" x 12.88" Oval Tray with Gold Border	12 ea	14.50/0.38
608918	21" x 15" Rectangular Tray with Ornate Border	12 ea	25.00/0.51
608908	18.25" x 12.38" Rectangular Tray with Gold Border	12 ea	20.00/3.06
608909	20.63" x 14" Rectangular Tray with Gold Border	12 ea	25.00/3.82
608901	17.13" x 11.75" Octagonal Tray with Beaded Border	12 ea	17.00/0.25
608902	20" x 13.75" Octagonal Tray with Beaded Border	12 ea	22.50/0.80



Festival Trays™

- Beautiful alternative to glass, crystal, or disposables
- Use durable trays for catering, parties, weddings, conventions, cruise lines, or poolside service
- Molded-in pattern gives the appearance of fine etched crystal
- Economical, break-resistant SAN resists food acids and oils
- Lowers replacement costs
- Safe in temperatures from 0° to 180°F
- Dishwasher safe



Round Heavy-Weight Tray

- Elegant simplicity with smooth, rich finish and rolled rim handle edge
- 18-8 stainless steel with mirror-polish finish
- Designed to stand up to frequent use
- Handwashing is recommended



Tray Stands

- Cross supports provide superior rigidity and strength
- Durable and easy to clean
- Available in 3 forms: Steel, Wood & Plastic
- Capped legs on steel tray stands prevent slipping and marring of floors
- Extra tall steel tray stand (C3625T) reduces need for bending and stooping; additional height makes transferring heavy loads easier
- Plastic stands have sanitary, non-porous & non-corrosive finish that is easy to clean with a damp cloth
- Works great with Griptite and GripLite trays



Prod No	Description	Color	Pack	Cs Wt/Cube
Festival Trays				
6413	13" Round Tray	07	12 ea	10.40/0.46
6416	16" Round Tray	07	12 ea	14.65/0.64
6417	12.5" x 7" Rectangular Tray	07	12 ea	3.65/0.16
6450	15" x 10.75" Rectangular Tray	07	12 ea	12.20/0.45
6426	22" x 16" Handled Tray	07	6 ea	15.95/1.04
6439	13" x 19.5" Handled Tray	07	6 ea	11.00/0.70
Round Heavy-Weight Tray				
608917	22" Round Heavy-Weight Tray	-	3 ea	16.97/0.78
Tray Stands				
C3625	31.5" Steel Stand	03	6 ea	38.75/5.65
C3625T	36" Tall Steel Stand	38	6 ea	56.00/6.59
C3620W	30" Wood Stand	11	6 ea	32.75/5.54
C3630W	30.5" Plastic Stand	11	6 ea	35.90/5.51



CARLISLE
FOODSERVICE PRODUCTS

RUGGED BEAUTIFUL PORTABLE CONVENIENT **CATERING EQUIPMENT**

Carlisle's catering equipment line is the professional's choice for your insulated transport needs. Only Carlisle Cateraide's can offer attractive contemporary styling, longer hold times, and unique battle tested features that provide you superior value.





Choose The CATERAIDE™ To Best Fit Your Needs.

All CATERAIDES are NSF Listed and made of rugged, stain, and scratch-resistant polyethylene.

Good

Pan carriers have exclusive, automatic, self-venting system. LD beverage servers have easy-grip, formed handles for easy transporting.



LD Series



Better

Carlisle's better line of CATERAIDES offers an ergonomic design for easy loading, handling, stacking and storing. The patented* Slide 'N Seal's lids and doors glide shut and stay closed without latches or gaskets. Slide 'N Seal's metal-free line makes it the perfect fit for correctional facilities.

*Slide 'N Seal Pan Carrier Patent No. 7,134,552



Slide 'N Seal





Best



Carlisle brings you the best in temperature retention products with the redesigned Cateraide IT insulated transport line. The Cateraide's sturdy construction offers a long-lasting product and the thick foam insulation holds temperatures in the safe zone for over 6 hours. Our special coating gives the IT a beautiful, glossy sheen. The new, sleek design gives an updated, contemporary look to any table setting.

IT Series





CATERAIDE™ IT

Introducing the **newly designed** Cateraide IT insulated transport line of products. IT is the only choice for foodservice professionals demanding they have it all. For the first time, rugged durability and industry leading safe food holding times are combined with **attractive, contemporary styling**. Cateraide IT sets a **new standard for value**.

Insulated Beverage Dispenser

- Heavy foam insulation holds temperatures in the safe zone for over 6 hours
- Field adjustable latches ensure a secure seal for the life of the carrier
- "Spring Action" faucet for no drip service
- Button-hole latch design offers convenient one hand operation and keeps the doors and lids closed tightly for better temperature retention
- Sure-grip handles promote a safe, stable, two-person lift for easy loading and unloading
- Custom logo printing available



IT500



YOUR LOGO HERE

Exclusive molded in process puts your logo in front of the customer. Contact your local sales rep for more details.



Prod No	Description	Color	Pack	Cs Wt/Cube
Cateraide IT				
IT250 Δ	2.5 gal Beverage Dispenser	03, 42, 62	1 ea	16.50/2.21
IT500 Δ	5 gal Beverage Dispenser	03, 43, 62	1 ea	21.00/2.81
IT1000 Δ	10 gal Beverage Dispenser	03, 43, 62	1 ea	29.50/5.19

NSF Listed products are designated with a Δ and may be prefixed with an N
Note: IT1000 can be shipped UPS/FedEx ground at oversize cost



End & Top Loader

- Heavy foam insulation holds temperatures in the safe zone for over 6 hours
- Secure stacking for easy transport and storage
- Sure-grip handles promote a safe, stable, two-person lift for easy loading and unloading
- Exclusive, low-profile, double hinge opens 270° for easy loading and unloading; lies flat to save space and makes it less likely to break
- Field adjustable latches ensure a secure seal for the life of the carrier
- Door hinge can be removed for easy, thorough cleaning
- Built-in seal eliminates gaskets on end & top loaders
- Holds six 2-1/2" deep food pans
- Use with CaterCooler to help keep foods at ServeSafe® temps longer (shown on page 160)
- Custom logo printing available

ServeSafe® is a registered trademark of the National Restaurant Association



Flat top design can be used as a prep surface when space is limited



Button-hole latch design offers convenient one hand operation



Exclusive double hinge opens 270°



IT400



IT410

4 rotating wheels give this dolly unmatched maneuverability



IT140



Prod No	Description	Color	Pack	Cs Wt/Cube
Cateraide IT				
IT400 Δ	End Loader (six pan capacity)	03, 43, 62	1 ea	43.00/8.53
IT140 Δ	4" Top Loader (holds one full size pan up to 4" deep)	03, 43, 62	1 ea	19.00/2.18
IT160 Δ	6" Top Loader (holds one full size pan up to 6" deep)	03, 43, 62	1 ea	20.50/2.79
IT180 Δ	8" Top Loader (holds one full size pan up to 8" deep)	03, 43, 62	1 ea	22.00/3.33
IT410 Δ	End Loader Dolly with Casters	03	1 ea	14.50/2.97
MYCK	Optional Caster Set	—	1 ea	10.00/0.79

NSF Listed products are designated with a Δ and may be prefixed with an N
 Note: IT180, IT400 can be shipped UPS/FedEx ground at oversize cost



CATERAIDE™ SLIDE 'N SEAL

Only the Carlisle Slide 'N Seal offers **latch free construction** with no metal parts. Perfect for outdoor use in recreation and leisure markets, schools, and correctional facilities.

Insulated Beverage Dispenser

- Revolutionary Slide 'N Seal design is combined with Carlisle's thick insulation to hold temperatures longer
- Patented* Slide 'N Seal design glides shut and closes tightly without latches
- The integrated seal keeps beverages hot or cold longer
- Sleek contemporary appearance; ergonomically designed for easy loading, handling, stacking, and storing
- Tough, scratch-resistant polyethylene construction is easy to clean and maintain
- No metal parts – ideal for correctional facilities
- "Spring action" faucet for dripless service
- NSF Listed

*Slide 'N Seal Patents Beverage Dispensers: Patent No. 7,328,816



Easy twist on/off lid for leak-proof transport

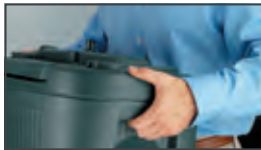

Molded-in handles for easy transport



Lock can be placed through molded-in tag hole for a secure, tamper-proof closure



XB5



XB3

Replacement parts shown on page 331



Prod No	Description	Color	Pack	Cs Wt/Cube
Slide 'N Seal Beverage Dispensers				
XB3 Δ	3 gal Slide 'N Seal Beverage Dispenser	03	1 ea	11.00/3.40
XB5 Δ	5 gal Slide 'N Seal Beverage Dispenser	01, 03, 08	1 ea	18.00/4.68

NSF Listed products are designated with a Δ and may be prefixed with an N



Top & End Loaders

- Revolutionary Slide 'N Seal design is combined with Carlisle's thick insulation to hold temperatures longer
- Patented* Slide 'N Seal lids and doors glide shut and stay closed without latches or gaskets
- The integrated seal keeps food hot or cold longer
- Self-venting lids and doors keep foods fresher, crisper and more appetizing
- Exclusive lid design has a molded-in tethered lock pin to seal carrier for safety
- End Loader has molded-in tag slot to seal and tag carrier for safety and food identification
- Sleek contemporary appearance; ergonomically designed for easy loading, handling, stacking and storing
- Tough, scratch-resistant polyethylene construction is easy to clean and maintain
- No metal parts – ideal for correctional facilities
- NSF Listed

*Slide 'N Seal Patents

Pan Carriers: Patent No. 7,134,552



Sliding doors easily open and close for quick access and transport



Replacement parts shown on page 331

Prod No	Description	Color	Pack	Cs Wt/Cube
Slide 'N Seal Top Loaders				
XT1400 Δ	4" Slide 'N Seal Top Loader	03	1 ea	18.35/2.82
XT1600 Δ	6" Slide 'N Seal Top Loader	01, 03, 08	1 ea	20.55/3.37
XT1800 Δ	8" Slide 'N Seal Top Loader	01, 03	1 ea	22.00/3.86
Slide 'N Seal End Loaders				
XT3000R Δ	Slide 'N Seal End Loader	01, 03	1 ea	20.00/8.10

NSF Listed products are designated with a Δ and may be prefixed with an N
NOTE: XT1800, XT3000R can be shipped UPS/FedEx Ground at oversize cost



CATERAIDE™ XT & LD

XT Series Insulated Beverage Dispenser - *The Value Leader*

- Made of rugged, stain- and scratch-resistant polyethylene
- Filled with extra thick foam insulation for maximum temperature retention
- Stacks with itself and with other major competitors
- Smooth interior walls and rounded corners leave no food traps and provides quick clean-up
- Convex lid design prevents leaks during use as pressure increases
- Modern XT lid design with convenient pop-up vent
- Improved O-ring seal eliminates leaks during transport
- Easy-grip, formed handles for transporting
- Sure-Latch™ wide design has three times the latch area of other beverage servers for a secure seal
- Latches are mounted into steel reinforcement plates for long life
- “Spring action” faucet for dripless service
- NSF Listed



Replacement parts shown on page 331



Prod No	Description	Color	Pack	Cs Wt/Cube
Cateraide XT Beverage Servers				
XT2500 Δ	2.5 gal Beverage Server	01, 03, 08, 59	1 ea	13.00/2.07
XT5000 Δ	5 gal Beverage Server	01, 03, 08, 59	1 ea	20.00/2.78
XT10000 Δ	10 gal Beverage Server	01, 03, 08, 59	1 ea	30.60/5.67

NSF Listed products are designated with a Δ and may be prefixed with an N
NOTE: XT10000 can be shipped UPS/FedEx Ground at oversize cost



LD Series Insulated Beverage Dispensers

- Made of rugged, stain- and scratch-resistant polyethylene
- Filled with extra thick foam insulation for maximum temperature retention
- Stacks with itself and with other major competitors
- Smooth interior walls and rounded corners leave no food traps and provides quick clean-up
- Convex lid design prevents leaks during use as pressure increases
- Reinforced, tight-fitting lids with O-ring seals prevent leaks and provide increased heat retention
- Easy-grip, formed handles for transporting
- “Spring action” faucet for dripless service
- Nylex II™ latches have no sharp edges, won't rust, bend or dent like metal, and are mounted into steel reinforcement plates for long life
- NSF Listed



Replacement parts shown on page 331



Prod No	Description	Color	Pack	Cs Wt/Cube
Cateraide LD Beverage Servers				
LD250N Δ	2.5 gal Beverage Server	01, 03	1 ea	12.75/2.02
LD500N Δ	5 gal Beverage Server	01, 03, 08, 59	1 ea	16.00/2.33
LD1000N Δ	10 gal Beverage Server	01, 03, 08, 59	1 ea	26.60/5.01

NSF Listed products are designated with a Δ and may be prefixed with an N
 NOTE: LD1000N can be shipped UPS/FedEx Ground at oversize cost



CATERAIDE™

Insulated Soup & Chili Servers - *Ideal for Food Festivals & Outdoor Venues*

- Same high-quality features and construction as our standard Cateraides
- Perfect for transporting and serving soup and chili
- Stacks with 2.5 gallon & 5 gallon beverage servers
- There are no faucets
- NSF Listed



CaterCooler™

- Freeze CaterCooler overnight or for eight hours and it will keep food at or below the ServSafe® guidelines of 40°F for up to eight hours without ice*
- Designed to slide into a Cateraide End Loader, Double End Loader, or place on top of food pans in a Top Loader
- Durable polyethylene shell

ServSafe® is a registered trademark of the National Restaurant Association

*Temperature retention is based on CaterCooler being pre-frozen for a minimum of eight hours, then placed directly into Cateraide pan carrier. Pan Carrier unit is then filled with pre-chilled food pans. Testing was conducted under ambient room temperatures of 76°F.



CaterCooler shown with PC300N End Loader



Prod No	Description	Color	Pack	Cs Wt/Cube
Cateraide Insulated Soup & Chili Servers				
LD350N Δ	3.5 gal Soup & Chili Server	01, 03	1 ea	12.30/1.78
LD500NSS Δ	5 gal Soup & Chili Server	01, 03	1 ea	17.75/2.25
CaterCooler				
PC660	CaterCooler	14	1 ea	12.30/0.46

NSF Listed products are designated with a Δ and may be prefixed with an N

NOTE: LD500NSS can be shipped UPS/FedEx Ground at oversize cost



Pan Carriers

- Cateraide construction made of rugged, stain- and scratch-resistant polyethylene
- Filled with extra thick foam insulation for maximum temperature retention
- Exclusive automatic self-venting system eliminates unsanitary vent openings and easily lost vent caps
- Heat resistant to 200°F
- Replacement parts shown on pages 331
- NSF Listed



Insulated Sheet Pan & Tray Carrier

- Individual tracks accommodate seven 18" x 26" trays
- Use with sheet pans shown on page 175
- NSF Listed



Insulated Top Loaders

- Accommodates all third, half, and full size food pans
- PC188N top loader holds up to 8" deep food pan



Insulated End Loader

- Individual track for each food pan
- PC300N end loader holds five 2.5" deep pans
- PC600N has twice the capacity of the PC300N
- PC600N's separate compartments enable you to put hot food in one; cold in the other
- NSF Listed



Prod No	Description	Color	Pack	Cs Wt/Cube
Cateraide Insulated Top Loaders				
PC140N Δ	12 qt, 4" Single Pan Carrier	01, 03	1 ea	14.10/2.03
PC160N Δ	18 qt, 6" Single Pan Carrier	01, 03	1 ea	16.50/2.63
PC180N Δ	24 qt, 8" Combination Pan Carrier	01, 03	1 ea	26.00/4.44
Cateraide Insulated Sheet Pan & Tray Carrier				
TC1826N Δ	Sheet Pan, Tray Carrier	01, 03	1 ea	45.00/8.74
Cateraide Insulated End Loaders				
PC300N Δ	End Loader	01, 03, 08, 59, 95	1 ea	30.50/6.33
PC600N Δ	Double End Loader	01, 03, 08, 59	1 ea	73.00/13.00

NSF Listed products are designated with a Δ and may be prefixed with an N

CATERAIDE™

Dollies - *Industry Leader*

Polyethylene Dollies

- 4" heavy-duty, quiet, and non-marking swivel casters
- Rolls easily on carpeted floors
- DL300R holds up to two Cateraide End Loaders (PC300N) or any Cateraide Top Loader
- XDL3000 holds up to two Slide 'N Seal End Loaders (XT3000R) when stacked
- NSF Listed



DL300R

XDL3000H



Aluminum Dollies

- Made of sturdy, light-weight, no-rust aluminum
- Plastic coated corner bumpers protect against marring furnishings
- 4" heavy-duty, quiet, and non-marking swivel casters
- Rolls easily on carpeted floors
- DL300 holds up to two stacked Cateraide End Loaders
- DL1826 holds up to three stacked Sheet Pan Carriers



DL1826

DL300

Universal

- Moves up to 6 fully loaded top loaders with ease, even on carpeted floors
- 600 lb load capacity
- Eyelets for cargo straps
- 5" non-marking casters (2 rigid, 2 swivel—one with brake)
- NSF Listed



UD1726



Black(03)	Aluminum(23)
-----------	--------------

Prod No	Description	Color	Pack	Cs Wt/Cube
Polyethylene Cateraide Dollies				
XDL3000H Δ	22.38" x 28.75" Dolly with Handle	03	1 ea	29.00/4.06
DL300R Δ	20.38" x 26.75" Dolly	03	1 ea	21.00/4.14
Aluminum Cateraide Dollies				
DL300	23.25" x 16.88" Dolly	23	1 ea	12.90/2.41
DL1826	28.63" x 22" Dolly	23	1 ea	13.35/2.90
Cateraide Universal Dolly				
UD1726 Δ	Universal Dolly	03	1 ea	43.65/8.59

NSF Listed products are designated with a Δ and may be prefixed with an N
 NOTE: Cateraide Universal Dolly is not UPS/FedEx Ground shippable





Insulated Ice Caddies

- Cateraide construction made of rugged, stain- and scratch-resistant polyethylene
- Filled with extra thick foam insulation for maximum temperature retention
- Rounded inside corners and removable lid for thorough cleaning
- Stainless steel, reinforced hinges prevent rusting
- Easy rolling, heavy-duty 5" casters
- Replacement parts shown on pages 331

200 Lb Caddy

- Lid opens and lays flat against side of unit to conserve space
- Front faucet for fast drainage and easy cleanup; inside has sloped base for complete drainage
- Includes convenient shelf; allows water to drain away from ice
- Dual handles for easy maneuverability
- 10" non-marking back wheels roll easily over rough surfaces



IC2220

125 Lb Caddies

- Nylex™ latches eliminate sharp edges; won't rust, bend, or dent
- Ice Caddies IC2250 and IC2254 are only 28.75" high for smaller, more compact space requirements
- IC2250T Ice Caddy is 36.5" high to reduce back bending motion
- IC2250T Ice Caddy has 8" non-marking back wheels for easy maneuvering over rough surfaces
- NSF Listed



IC2250T

IC2254



Prod No	Description	Color	Pack	Cs Wt/Cube
Cateraide Ice Caddies				
IC2220	200 lb Ice Caddy with Ice Caddy Shelf; 10" Wheels, 2 Swivel Casters (one with brake)	01, 03, 08, 59	1 ea	74.00/17.99
IC2250 Δ	125 lb Ice Caddy; 2 Rigid Casters, 2 Swivel Casters (one with brake)	01, 03	1 ea	49.00/11.63
IC2254 Δ	125 lb Ice Caddy; 4 Swivel Casters (one with brake)	01, 03	1 ea	55.00/11.56
IC2250T Δ	125 lb Tall Ice Caddy; 8" Wheels, 2 Swivel Casters (one with brake)	03	1 ea	57.00/14.56

NSF Listed products are designated with a Δ and may be prefixed with an N

Note: Ice Caddies cannot ship UPS/FedEx Ground



CARLISLE
FOODSERVICE PRODUCTS

QUALITY
DURABLE
STRONG
**PROFESSIONAL
COOKWARE**

Carlisle cookware and bakeware is designed to support professional chefs, helping them to succeed in their constant pursuit to delight their guests with great food. Our wide selection of top-quality products delivers reliable, long-lasting value to your operation.





FRY PANS

Excalibur Fry Pans feature a **reinforced non-stick coating** to protect your fry pans from daily wear and tear.

Excalibur® Fry Pans

- Stainless steel reinforced non-stick coating is micro-bonded to the substrate of the pan creating a multi-layer surface that easily releases food and resists scratching better than traditional non-stick surfaces
- Excalibur cooks food evenly without the need for added fat or oil
- Hard 3004 aluminum body stands up to the toughest foodservice environment
- Removable Dura-Kool™ Sleeves
- Use with High Heat Turner shown on page 198 of the foodservice catalog
- NSF Listed



60908XRS

60907XRS

60910XRS
60912XRS
60914XRS

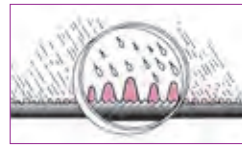

Excalibur® surface resists scratching from metal utensils better than any other coating

Teflon Select® Fry Pan

- Teflon Select, DuPont's professional non-stick surface is extremely durable and extra smooth
- Improved coating features 75% greater longevity and 75% more resistance to abrasion than regular Teflon
- Hard 3004 aluminum body stands up to the toughest foodservice environment
- Use with High Heat Turner shown on page 198 of the foodservice catalog
- NSF Listed



60910SERS
60912SERS
60914SERS

60908SERS

60907SERS

Prod No	Description	Cover	Pack	Cs Wt/Cube
Excalibur Fry Pans				
60907XRS Δ	7" Excalibur Fry Pan	60907C	12 ea	15.00/0.53
60908XRS Δ	8" Excalibur Fry Pan	60908C	12 ea	19.00/0.77
60910XRS Δ	10" Excalibur Fry Pan	60910C	6 ea	16.00/0.76
60912XRS Δ	12" Excalibur Fry Pan	60912C	6 ea	21.00/1.13
60914XRS Δ	14" Excalibur Fry Pan	60914C	3 ea	15.00/1.42
Teflon Select Fry Pans				
60907SERS Δ	7" Teflon Select Fry Pan	60907C	12 ea	15.00/0.53
60908SERS Δ	8" Teflon Select Fry Pan	60908C	12 ea	19.00/0.77
60910SERS Δ	10" Teflon Select Fry Pan	60910C	6 ea	16.00/0.76
60912SERS Δ	12" Teflon Select Fry Pan	60912C	6 ea	21.00/1.13
60914SERS Δ	14" Teflon Select Fry Pan	60914C	3 ea	15.00/1.42

NSF Listed products are designated with a **Δ** and may be prefixed with an N
Teflon® is a registered trademark of E.I. DuPont® DeNemours & Co., Inc.
Excalibur® is a registered trademark of Whitford B. U. Corp.

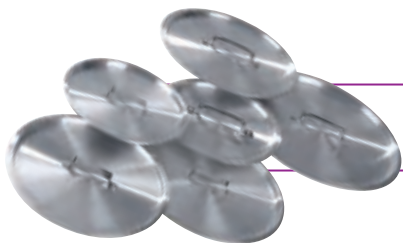

Covers sold separately on page 171
Recommended covers listed in the product charts

Traditional Aluminum Fry Pans

- Hard 3004 aluminum body stands up to the toughest foodservice environment
- Gently sloped sides are ideal for turning, flipping, and removing foods
- Aluminum material provides excellent heat transfer
- NSF Listed



SSAL™ Fry Pans

- Finest 18-8 stainless interior is permanently bonded to hard aluminum body to create the ultimate fry pan for any foodservice environment
- Aluminum body ensures maximum heat transfer throughout the pan and eliminates hot spots and scorching
- Easy care stainless interior is incredibly durable and will not react with food or discolor sauces
- Special rivet design securely attaches handle to pan; bond will not loosen like traditional rivets
- NSF Listed



Prod No	Description	Cover	Pack	Cs Wt/Cube
Traditional Aluminum Fry Pans				
60907RS Δ	7" Aluminum Fry Pan	60907C	12 ea	15.00/0.53
60908RS Δ	8" Aluminum Fry Pan	60908C	12 ea	19.00/0.77
60910RS Δ	10" Aluminum Fry Pan	60910C	6 ea	16.00/0.76
60912RS Δ	12" Aluminum Fry Pan	60912C	6 ea	21.00/1.13
60914RS Δ	14" Aluminum Fry Pan	60914C	3 ea	15.00/1.42
SSAL Fry Pans				
60708RS Δ	8" SSAL Fry Pan	60908C	12 ea	17.00/0.69
60710RS Δ	10" SSAL Fry Pan	60910C	6 ea	16.00/0.68
60712RS Δ	12" SSAL Fry Pan	60912C	6 ea	19.00/0.78

NSF Listed products are designated with a Δ and may be prefixed with an N



COOKWARE

Standard Weight Aluminum Cookware

Standard Weight Aluminum Cookware is made from 3003 alloy that allows cookware to heat rapidly and retain even heat. A double thick top edge and base offer superior strength and shape retention. All Standard Weight Aluminum Cookware is NSF Listed.

PROFESSIONAL COOKWARE



Stock Pots

- Perfect for preparing soups, pastas, or long-simmering stocks and sauces
- Can also be used with our stainless steel baskets for steaming, boiling, or deep frying

Braziers

- Brazier's wide surface is perfect for browning meats and simmering stews
- Heavy plated loop handles for easy transport
- Optional covers maintain moist heat for slow cooking

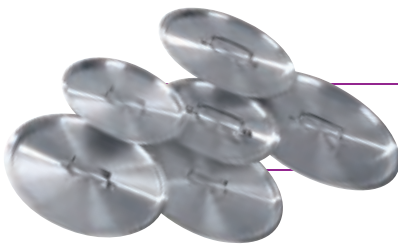

Covers sold separately on page 171
Recommended covers listed in the product charts

Prod No	Description	Cover	Pack	Cs Wt/Cube
Standard Weight Stock Pots				
61210 Δ	10 qt Standard Weight Stock Pot	61210C	1 ea	4.00/0.53
61212 Δ	12 qt Standard Weight Stock Pot	61210C	1 ea	4.30/0.79
61216 Δ	16 qt Standard Weight Stock Pot	61216C	1 ea	5.20/0.97
61220 Δ	20 qt Standard Weight Stock Pot	61220C	1 ea	6.50/1.20
61224 Δ	24 qt Standard Weight Stock Pot	61224C	1 ea	6.50/1.43
61232 Δ	32 qt Standard Weight Stock Pot	61232C	1 ea	9.10/1.89
61240 Δ	40 qt Standard Weight Stock Pot	61240C	1 ea	9.80/2.30
61260 Δ	60 qt Standard Weight Stock Pot	61260C	1 ea	13.80/3.40
61280 Δ	80 qt Standard Weight Stock Pot	61280C	1 ea	15.90/4.27
61200 Δ	100 qt Standard Weight Stock Pot	61200C	1 ea	17.60/4.94
Standard Weight Braziers				
61115 Δ	15 qt Standard Weight Brazier	61232C	1 ea	9.24/0.81
61120 Δ	20 qt Standard Weight Brazier	61120C	1 ea	11.66/0.92
61125 Δ	25 qt Standard Weight Brazier	61125C	1 ea	11.66/0.92
61130 Δ	30 qt Standard Weight Brazier	61130C	1 ea	13.64/1.59

NSF Listed products are designated with a Δ and may be prefixed with an N



Sauté Pans

- Low sided sauté pans are designed for high heat browning or quick cooking
- Come with removable Dura-Kool sleeves
- Heavy-weight aluminum



Straight Sided Aluminum Sauce Pans

- Rounded corners for easy stirring, helps prevent thick sauces from burning
- Heavy-duty, straight-sided pan's thick base provides quick and even heating for thorough cooking



Tapered Aluminum Sauce Pans

- Tapered shape reduces contact with direct heat source and encourages cooking by diffusing heat from the side walls
- Sides are gently sloped and corners are rounded for easy stirring
- Tapered design nests for convenient storage
- Extra wide lip adds durability and offers more precise pouring
- 14 qt saucepan has side handle to aid lifting



Sectional Pasta Cookers

- Ideal for pasta, vegetables, and seafood
- Save time, energy, and space by cooking multiple portions in one pot
- Stainless steel inserts with .13" holes feature cool-touch handles and can be hooked on the side of the pot for easy draining
- Complete unit includes 20 qt pot and 4 quarter size inserts

Prod No	Description	Cover	Pack	Cs Wt/Cube
Standard Weight Sauté Pans				
61905 Δ	5 qt Sauté Pan	61905C	6 ea	18.00/2.18
61907 Δ	7 qt Sauté Pan	61907C	6 ea	15.00/2.40
Standard Weight Straight Sided Sauce Pans				
61302 Δ	2.5 qt Standard Weight Sauce Pan	61302C	6 ea	14.00/2.01
61305 Δ	5 qt Standard Weight Sauce Pan	61305C	6 ea	19.00/4.66
61308 Δ	8.5 qt Standard Weight Sauce Pan	61308C	6 ea	28.87/3.50
Standard Weight Tapered Sauce Pans				
61702 Δ	2.5 qt Tapered Sauce Pan	61702C	6 ea	9.50/0.78
61704 Δ	4.5 qt Tapered Sauce Pan	61704C	6 ea	12.80/3.17
61707 Δ	6 qt Tapered Sauce Pan	61707C	6 ea	17.00/2.92
61708 Δ	8.5 qt Tapered Sauce Pan	61708C	6 ea	20.70/3.82
61710 Δ	10 qt Tapered Sauce Pan	61710C	6 ea	22.00/4.87
Sectional Pasta Cooker				
60100PC	Quarter Size Sectional Pasta Cooker includes 20 qt pot with 4 inserts	—	1 ea	12.00/1.80
60102	20 qt Pot for Pasta Cooker Combination	—	2 ea	10.00/1.79
60101	Quarter Size Perforated Insert	—	4 ea	7.00/1.80

NSF Listed products are designated with a Δ and may be prefixed with an N



COOKWARE

Mesh Baskets

Nickel Plated

- Perfect for cooking or reheating single servings of pasta
- Baskets can also be used for small batch frying or breading
- Stainless baskets feature cool-touch handles and heavy-duty chrome steel hook for draining basket



Nickel Plated

Chrome Plated

- Chrome plated carbon steel basket is designed for small batch deep frying
- Chrome plated carbon basket not intended for use in water

Burger Cover

- Accelerates cooking on grill tops
- Aluminum cover provides quick and even heating for thorough cooking
- Helps retain flavor and moisture
- Heat resistant knob is cool to the touch



Double Boiler

- Heavy-duty construction and extra thick base for superior thermal conductivity; prevents scorching of delicate sauces, chocolate, and more
- Traditional weight, satin finish cookware
- Durable rolled edge with sanitary open bead
- Double boiler includes stock pot, insert and cover; inserts are also available separately
- NSF Listed



Prod No	Description	Pack	Cs Wt/Cube
Nickel Plated Mesh Baskets			
601028	8.75" Fryer Basket	12 ea	18.00/2.92
601029	9.75" Fryer Basket	12 ea	20.00/2.92
601031	11.5" Fryer Basket	12 ea	26.00/2.92
Chrome Plated Carbon Steel Mesh Baskets			
601000	8.75" Fryer Basket	12 ea	17.00/1.66
601001	9.75" Fryer Basket	12 ea	19.00/2.41
601002	11.5" Fryer Basket	12 ea	25.00/3.10
601003	13.5" Fryer Basket	12 ea	39.00/4.22
Burger Cover			
60103	6" Burger Cover	12 ea	4.00/0.81
Double Boilers			
60921 Δ	12 qt Double Boiler with 12 qt Insert	1 ea	10.00/1.72
60934 Δ	20 qt Double Boiler with 16 qt Insert	1 ea	13.00/2.17

NSF Listed products are designated with a Δ and may be prefixed with an N



Heavy-Duty Covers

- Carlisle's unique reinforced design resists dents and holds its shape better than old-fashioned lids
- Extra heavy-duty covers are fabricated from hard 3004 aluminum to stand up to the toughest foodservice environment
- Open looped handles are securely riveted
- NSF Listed

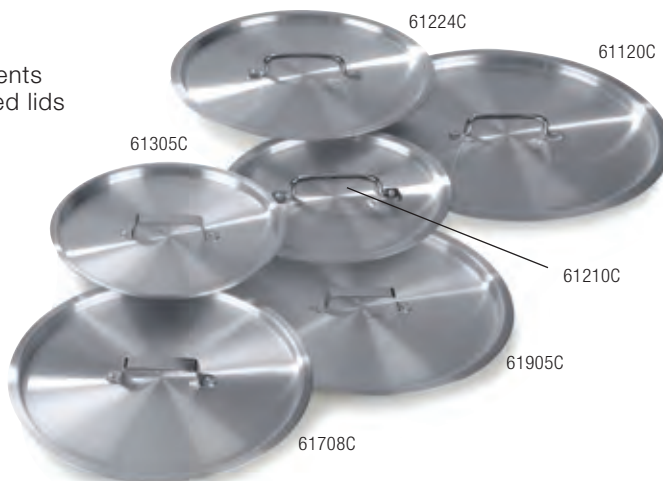

Domed Fry Pan Covers

- Domed covers fit snugly on the pans creating a self-basting effect by allowing moisture to condense and return to the pan
- Strong welds on handle ensure long life
- NSF Listed



Prod No	Description	Pack	Cs Wt/Cube
Heavy-Duty Covers			
61120C Δ	Cover for 61120	6 ea	12.80/1.71
61125C Δ	Cover for 61225	6 ea	14.80/1.96
61130C Δ	Cover for 61130	6 ea	19.60/2.75
61200C Δ	Cover for 61200	6 ea	19.58/2.72
61210C Δ	Cover for 61210 & 61212	6 ea	4.40/0.52
61216C Δ	Cover for 61216	6 ea	6.00/0.63
61220C Δ	Cover for 61220	6 ea	6.00/0.69
61224C Δ	Cover for 61224	6 ea	6.00/0.82
61232C Δ	Cover for 61232 & 61115	6 ea	10.60/1.32
61240C Δ	Cover for 61240	6 ea	11.20/1.45
61260C Δ	Cover for 61260	6 ea	14.80/1.96
61280C Δ	Cover for 61280	6 ea	17.00/2.36
61302C Δ	Cover for 61302	6 ea	3.10/0.33
61305C Δ	Cover for 61305	6 ea	4.20/0.48
61308C Δ	Cover for 61308	6 ea	5.10/0.55
61702C Δ	Cover for 61702	6 ea	3.10/0.33
61704C Δ	Cover for 61704	6 ea	3.80/0.42
61707C Δ	Cover for 61707	6 ea	5.10/0.55
61708C Δ	Cover for 61708	6 ea	5.30/0.59
61710C Δ	Cover for 61710	6 ea	6.00/0.78
61905C Δ	Cover for 61905	6 ea	6.00/0.69
61907C Δ	Cover for 61907	6 ea	8.30/0.75
Domed Fry Pan Covers			
60907C Δ	7" Dome Fry Pan Cover	6 ea	3.10/0.30
60908C Δ	8" Dome Fry Pan Cover	6 ea	4.00/0.38
60910C Δ	10" Dome Fry Pan Cover	6 ea	5.55/0.57
60912C Δ	12" Dome Fry Pan Cover	6 ea	8.00/0.72
60914C Δ	14" Dome Fry Pan Cover	3 ea	5.85/0.35

NSF Listed products are designated with a Δ and may be prefixed with an N



BAKEWARE

Roast & Bake Pans

- Extra large, heavy-duty sizes capable of holding multiple roasts, hams, or turkeys
- Reinforced rolled edge for added strength
- 60306, 601923 have securely riveted drop handles for easier and safer lifting of heavy loads
- NSF Listed



601922



60306



601923

Commercial Weight Double Roasters

- Commercial weight aluminum roasters are equipped with 2 steel reinforced bands for extra heavy usage
- Pans feature seamless drawn sanitary open bead
- Covers and bases can also be used individually as open roasters
- Full size pans fit standard baker's racks
- Drop handles are securely riveted
- 60345's fabricated lugs hold top securely in place
- NSF Listed



60346



60344



60345

Prod No	Description	Pack	Cs Wt/Cube
Roast & Bake Pans			
60306 Δ	21 ga, 8 qt Bake Pan with Drop Handles; 17" x 11" x 2.5"	6 ea	27.55/2.97
601922 Δ	17 ga, 13.5 qt Bake Pan; 26" x 18" x 2.25"	4 ea	51.54/1.79
601923 Δ	17 ga, 19 qt Bake Pan with Drop Handles; 26" x 18" x 3.5"	6 ea	40.04/2.58
Commercial Weight Double Roasters			
60346 Δ	Double Roaster; 24" x 18" x 9" (includes 60344 & 60345)	1 ea	22.00/2.12
60344 Δ	16 ga, 26 qt Roast Pan (use as cover); 24" x 18" x 4.5"	2 ea	37.70/3.48
60345 Δ	16 ga, 26 qt Roast Pan (use as base); 24" x 18" x 4.5"	2 ea	38.14/3.69

NSF Listed products are designated with a Δ and may be prefixed with an N



Aluminized Steel Pans



Baking Pans

- Aluminized steel pans are the ultimate choice for baking breads, cupcakes, muffins, and cakes
- The special finish provides greater heat transfer for lower baking temperatures, shorter baking time, and better looking, more uniform baked goods
- Corrosion-resistant material withstands temperatures in excess of 700°F
- Individual seamless cups are locked into heavy frames

Bread Pans & Pullman Pans

- Aluminized steel pans are the ultimate choice for baking breads and cakes



Prod No	Description	Pack	Cs Wt/Cube
Aluminized Steel Baking Pans			
601829	24 Cup/1.75 oz Mini-Muffin/Cupcake Pan	6 ea	24.00/0.61
601830	12 Cup/3.5 oz Heavy-Duty Cupcake Pan	12 ea	21.00/0.58
601840	24 Cup/3.5 oz Heavy-Duty Cupcake Pan	6 ea	32.00/0.79
601834	12 Cup/4 oz Large Cup Cupcake Pan	6 ea	9.15/0.55
601837	12 Cup/6 oz Extra Large Cup Cupcake Pan	6 ea	27.00/0.90
606902	6 Loaf Mini Loaf Pan	6 ea	22.00/1.04
606903	12 Loaf Mini Loaf Pan	6 ea	24.00/1.16
Aluminized Steel Bread Pans			
604144	1 lb Loaf Bread Pan	12 ea	14.00/0.60
604174	1.75 lb Loaf Bread Pan	12 ea	17.00/1.39
Aluminized Steel Pullman Pans			
602164	32 oz Pullman Pan with Cover	12 ea	34.00/2.40
602164C	Pullman Pan Cover (only)	12 ea	8.00/0.25
602164P	Pullman Pan (only)	12 ea	26.00/2.19



BAKEWARE

Heavy-Duty Muffin Pan

- Heavy-duty muffin pan has seamless cups locked into heavy aluminum frame
- Holds up in busy foodservice environments



Pie Pans

- Heavy 18 gauge, natural finish aluminum spreads heat evenly for better baking



Springform Pans

- Use for cheesecakes, batter cakes, and other specialty items
- Heavy gauge, natural finish aluminum distributes heat evenly for better baking
- Heavy-duty frame has quick-release, spring-form sides for easy removal and quick clean-up



Prod No	Description	Pack	Cs Wt/Cube
Heavy-Duty Muffin Pan			
602424	24 Cup/3 oz Aluminum Muffin Pan	12 ea	32.00/1.82
Pie Pans			
60322	9" Pie Pan – 1.25" Deep	24 ea	12.00/0.82
60324	10" Pie Pan – 1.31" Deep	24 ea	14.00/0.82
Springform Pans			
6041	8" Springform Pan	6 ea	5.00/1.21
6042	9" Springform Pan	6 ea	5.00/1.21
6043	10" Springform Pan	6 ea	6.00/1.33
6044	12" Springform Pan	6 ea	7.00/2.55



Bun Pans & Sheet Pans

- Sturdy bun pans for baking, transporting, and displaying cookies, bread, and pastries
- Aluminum surface allows even browning of foods
- Manufactured from extra hard, tempered aluminum alloy with galvanized steel wire reinforced bead
- Tapered shape stacks for storage
- Use with Icing Grates listed below



601825
601828
601824

Icing Grates

- Use grates for thawing foods or cooling and icing cakes, cookies, and desserts
- 601306 welded icing grate fits full size bun pans and is made of nickel plated steel
- 601642, 601647 mesh icing grates are made of heavy, steel mesh wire

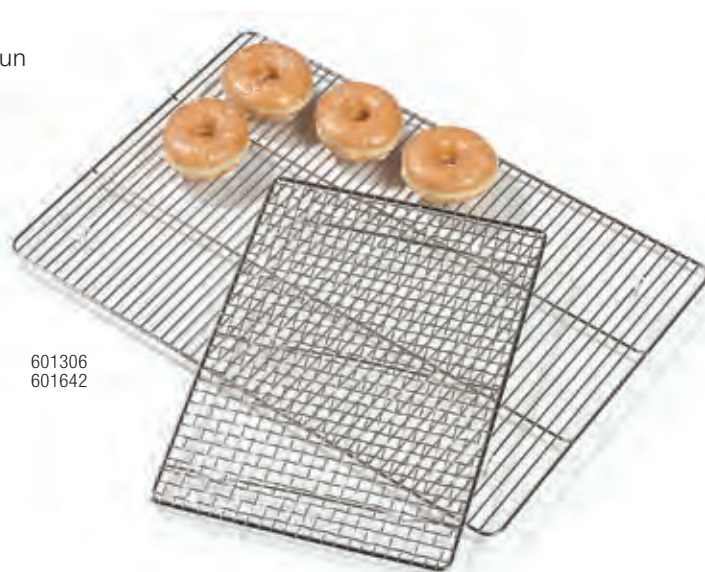

601306
601642

Prod No	Description	Pack	Cs Wt/Cube
Bun Pans & Sheet Pans			
601825	18 ga, Full Size Sheet Pan; 25.75" x 17.81" x 1.13"	12 ea	39.00/1.59
601826	16 ga, Heavy-Duty Full Size Sheet Pan; 25.75" x 17.81" x 1.13"	12 ea	46.00/1.59
601824	18 ga, Half Size Bun Pan; 17.81" x 12.88" x 1"	12 ea	21.60/0.93
601828	18 ga, Perforated Full Size Sheet Pan; 25.75" x 17.81" x 1.13"	12 ea	36.00/1.59
Icing Grates			
601306	Icing Grate, Fits 601825, 601826, 601828 Bun Pan	12 ea	38.00/1.01
601642	Mesh Icing Grate, Fits 601824 Bun Pan	12 ea	18.00/1.21
601647	Mesh Icing Grate, Fits 601825, 601826, 601828 Bun Pan	12 ea	32.00/1.08



CARLISLE
FOODSERVICE PRODUCTS

QUALITY
EFFICIENT
DURABLE
INNOVATIVE
**KITCHEN
ACCESSORIES**

Designed and used by chefs, Carlisle kitchen accessories are designed to improve food safety and quality, save labor, and reduce waste. You need to operate your kitchen efficiently and effectively every day and you can count on Carlisle to help make work easier.





CUTTING BOARDS & ACCESSORIES

Sparta® Spectrum® Cutting Boards

- Sparta Spectrum Color-Coded Products are a key group of CCP (Critical Control Point™) Products designed to promote safe food handling and help prevent hazardous cross-contamination
- Help meet HACCP guidelines by promoting segregated food prep for different foods
- HDPE (High Density Polyethylene) construction offers a durable cutting surface, and a high stability, warp-resistant cutting board
- Hygienic surface texture on boards prevents deep cuts and is easy to clean
- Contact your local Carlisle Sales Representative for custom sizing
- NSF Listed; dishwasher safe



	Prepared Food, Dry Food & Dairy
	Produce
	Meat
	Fish
	Poultry



10889WC Laminated Spectrum Wall Chart for quick color usage reference



NSF mark is permanently stamped on board to meet health department requirements

Spectrum Wall Chart

- Quick reference laminated chart in both English and Spanish
- Included with all assortment cutting board packs
- Sold separately

Produce



Spectrum color-coded cutting boards promote safe food handling

Dairy



Color-coding to food type helps prevent hazardous cross-contamination

Fish



Use Spectrum brushes for a complete HACCP system



Accessories

- Carlisle's Cutting Board Accessories support a complete HACCP System

Board & Brush Racks

- All products are dishwasher safe and easy to clean

Sparta Spectrum Cutting Board Brushes

- Ergonomically shaped handles and crimped stapleset polyester bristles are rugged and will not absorb food oils or moisture

Griptite Mat

- Textured mat holds boards in place
- NSF Listed; dishwasher safe



Cutting Board Scraper/Refinisher Tool

- Removes cuts from cutting boards
- Saves money on fewer replacement cutting boards
- Dishwasher safe

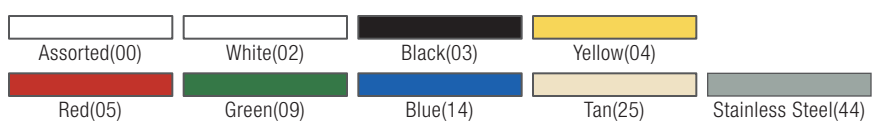

Prod No	Description	Color	Pack	Cs Wt/Cube
Cutting Boards				
10901 ▲	6" x 9" x .5" White Board	02	6 ea	5.50/0.13
10880 ▲	12" x 18" x .5" Assortment Pack	00	1 pk	16.45/0.52
10881 ▲	12" x 18" x .5" White Board	02	6 ea	22.70/0.45
10882 ▲	12" x 18" x .5" Color Board	04, 05, 09, 14, 25	6 ea	17.05/0.51
12881 ▲	12" x 18" x .75" White Board	02	3 ea	17.65/0.37
12882 ▲	12" x 18" x .75" Color Board	04, 05, 09, 14, 25	3 ea	17.65/0.37
10883 ▲	15" x 20" x .5" Assortment Pack	00	1 pk	23.25/0.73
10884 ▲	15" x 20" x .5" White Board	02	6 ea	32.50/0.68
10885 ▲	15" x 20" x .5" Color Board	04, 05, 09, 14, 25	6 ea	23.60/0.70
12886 ▲	15" x 20" x .75" White Board	02	3 ea	24.00/0.46
12887 ▲	15" x 20" x .75" Color Board	04, 05, 09, 14, 25	3 ea	24.00/0.46
10886 ▲	18" x 24" x .5" Assortment Pack	00	1 pk	33.40/1.04
10887 ▲	18" x 24" x .5" White Board	02	6 ea	31.20/1.04
10888 ▲	18" x 24" x .5" Color Board	04, 05, 09, 14, 25	6 ea	33.90/1.04
12891 ▲	18" x 24" x .75" White Board	02	3 ea	34.65/0.69
12892 ▲	18" x 24" x .75" Color Board	04, 05, 09, 14, 25	3 ea	36.00/0.67
10897 ▲	24" x 24" x .5" White Board	02	6 ea	55.00/1.25
12901 ▲	24" x 24" x .75" White Board	02	3 ea	45.75/0.90
Board & Brush Racks				
11879	Professional Board & Brush Rack	03	1 ea	6.40/0.73
Sparta Spectrum Cutting Board Brushes				
40521	6" Cutting Board Brush with Polyester Bristles, 1.38" trim	02, 04, 05, 09, 14, 25	12 ea	5.20/0.30
Cutting Board Scraper/Finisher Tool				
11789	Cutting Board Refinisher	02	12 ea	3.80/0.42
11799	Replacement Refinisher Blades (2 pk)	44	12 pk	1.50/0.04
Griptite Mat				
11801 ▲	Griptite 13" x 18" Cutting Board Mat	14	6 ea	6.43/0.62
Spectrum Wall Chart				
10889WC	Spectrum Color-Coded Cross-Contamination Wall Chart	00	6 ea	1.15/0.22

NSF Listed products are designated with a ▲ and may be prefixed with an N



HEAT LAMPS

Heat Lamps

- Wide selection of heat lamps for both front-of-the-house buffet service and back-of-the-house temperature retention

Heat Lamps shown are for U.S. use only. Ask your Carlisle Customer Service Representative for details on ordering Heat Lamps for international use

Flexiglow™

- Spun aluminum shade with flared rim for added strength
- Shade is drilled for increased heat dissipation
- Optional NSF Listed maple cutting board and drip pan is perfect for a front-of-the-house carving station
- Meets Standard Electrical Specifications shown
- Rated UL recognized

Dual Arm Flexiglow

- Two flex arms provide heating for separate products
- Vinyl-coated arms help keep unit sanitary
- Includes two 250-watt Red bulbs

Single Arm Flexiglow

- Switch located away from the heat source
- Includes 250 watt Red bulb



One Year Warranty against defects in materials and workmanship



HL8195B



HL8285GB



HL8185



HLA20



HL8285



Two Bulb Adjustable

- Adjustable arm for different heat settings
- Spun aluminum shades with flared rim for added strength and more even heat dissipation
- Ceramic insulated sockets with nickel plated contacts to prevent fusing
- Meets Standard Electrical Specifications shown on facing page
- On/off switch mounted on arm away from heat zone
- Includes two 250-watt Clear bulbs
- UL & CSA listed



Standard Electrical Specifications

- Sockets are ceramic insulated and furnished with a nickel-plated copper screw shell and contact point to prevent fusing
- Internal wiring is braided and silicone covered and rated 200°C
- Durable 16 gauge external wiring with molded three-prong plug
- All switches are either “T” or “L” rated and surpass minimum requirements
- All switches are located out of the heat zone
- Designed to operate on 110-120 volt AC service; wiring will accommodate 250 volt AC service
- Heat lamps have one year warranty against defects in materials and workmanship

Replacement Parts shown on page 333



Prod No	Description	Color	Pack	Cs Wt/Cube
Flexiglow Heat Lamps				
HL8285 ▲	Dual Arm Flexiglow, Aluminum, 24" Arm	00	1 ea	8.80/3.00
HL8285G ▲	Dual Arm Flexiglow, Gold, 24" Arm	21	1 ea	8.80/3.00
HL8285B** ▲	Dual Arm Flexiglow with Board & Pan, Aluminum, 24" Arm	00	1 ea	30.25/3.91
HL8285GB** ▲	Dual Arm Flexiglow with Board & Pan, Gold, 24" Arm	21	1 ea	31.00/3.91
HL8185 ▲	Flexiglow, Aluminum, 24" Arm	00	1 ea	6.25/1.55
HL8185G ▲	Flexiglow, Gold, 24" Arm	00*	1 ea	7.25/1.55
HL8185C	Flexiglow, Aluminum, 24" Arm, Includes Clamp	00	1 ea	7.95/1.55
HL8185GC	Flexiglow, Gold, 24" Arm, Includes Clamp	00*	1 ea	26.00/1.55
HL8185B** ▲	Flexiglow with Board & Pan, Aluminum, 24" Arm	00	1 ea	26.65/3.91
HL8185GB** ▲	Flexiglow with Board & Pan, Gold, 24" Arm	21	1 ea	26.65/3.91
HLA20	Flexiglow Clamp (8100 & 8200 Series)	00*	1 ea	1.70/0.22
HL8195 ▲	Flexiglow Aluminum, 39" Arm	00	1 ea	7.50/2.33
HL8195B** ▲	Flexiglow with Board, Aluminum, 39" Arm	00	1 ea	27.65/3.91
Two Bulb Adjustable Heat Lamp				
HL7237 ▲	Two Bulb Free Standing Adjustable Heat Lamp	00	1 ea	9.40/4.99
HL7237PS	Two Bulb Free Standing Adjustable Heat Lamp with 13" x 21" SS Pan & Screen	00	1 ea	14.00/4.99

NSF Listed products are designated with a ▲ and may be prefixed with an N
 **Includes 18" x 26" drip pan and 16" x 24" maple cutting board

Note: To allow for choice of lamp placement, holes in board are not pre-drilled

Note: HL8185B, HL8185GB, HL8195, HL8195B, HL8285, HL8285G, HL8285B, HL8285GB can be shipped UPS/FedEx Ground at oversize cost

Note: Heat Lamps sold or shipped outside the U.S. do not include a plug or bulb(s)



ORDER WHEELS AND RACKS

Order Wheels

- Keeps orders in clear view during preparation
- Rugged stainless steel construction
- Unique ball/spring clips for easy, one-handed check placement
- Custom length (381EX) extensions available for counter and ceiling mount models

Counter Mount Model

- Wheel mounts to any counter
- 9" extension & plate included

Ceiling Hung Model

- Square "CH" plate on top of axle mounts to ceiling with 4 screws

Note: Ceiling hung model does not include an extension. Extender must be purchased separately

Wall Mounted Model

- Wheel mounts to any wall
- Extension & plate included

Pedestal Model

- Heavy chrome 10" round base won't tip
- Rubber footprint prevents slipping and protects counter tops
- Includes 9" extension for adjustable height



Replacement Parts shown on page 333

Slide Order Racks

- Ball-bearing action provides clean look & one-handed sliding action
- Choose from rugged stainless steel or economical aluminum options
- Custom lengths are available by special order



Prod No	Description	Pack	Cs Wt/Cube
Order Wheels			
3812MP	12 Clip, 14" Portable Order Wheel	1 ea	10.60/1.30
3816MP	16 Clip, 18" Portable Order Wheel	1 ea	12.05/1.57
3820MP	20 Clip, 23" Portable Order Wheel	1 ea	13.75/2.49
3812CM	12 Clip, 14" Counter Mount Order Wheel	1 ea	3.80/0.61
3812CH	12 Clip, 14" Ceiling Hung Order Wheel	1 ea	3.20/0.61
3816CH	16 Clip, 18" Ceiling Hung Order Wheel	1 ea	4.45/1.13
3820CH	20 Clip, 23" Ceiling Hung Order Wheel	1 ea	4.95/1.30
3816WH	16 Clip, 18" Wall Mounted Order Wheel with 9" Extension	1 ea	5.20/1.13
Slide Order Racks			
38360	36" Stainless Steel Slide Order Rack	3 ea	8.55/0.30
38480	48" Stainless Steel Slide Order Rack	3 ea	11.50/0.51
38180A	18" Aluminum Slide Order Rack	3 ea	3.10/0.11
38240A	24" Aluminum Slide Order Rack	3 ea	4.30/0.20
38360A	36" Aluminum Slide Order Rack	3 ea	6.70/0.32
38480A	48" Aluminum Slide Order Rack	3 ea	8.80/0.51



IceMaster™ Ice Transport Tote

- Sturdy, high-impact material is less susceptible to cracking and breaking than other totes
- Includes molded-on Comfort Grip™ handle and side helper handle for emptying
- Helper handle doubles as drain hook
- Securely attaches upside down to edge of wire shelving or locks into mounting bracket to drain tote
- Optional mounting bracket can be attached to walls or the side of an ice bin
- Lid also available; protects against contaminants
- NSF Listed



Ice Only Container

- Safely and easily transports small loads of ice
- Perfect for filling food bars or other iced food displays, ice bins on portable bars, or even automatic ice dispensers at self-serve beverage stations
- Heavy-duty construction and ergonomic Comfort Curve™ handles provide easy handling; deep hand holds on base for controlled tipping
- Lids are reinforced and have snap down tab lock
- Imprinted on two sides in both English & Spanish
- NSF Listed



Scoops

Great economical choice for your front and back of house ice handling needs.

Metal Scoops

- Heavy-duty scoops have easy to hold pistol-grip handles with clearly marked capacities

Polycarbonate Scoops

- Easy-grip plastic handle doesn't transfer cold
- Features a hole for hanging or tying to a container
- Durable polycarbonate material
- NSF Listed; dishwasher safe

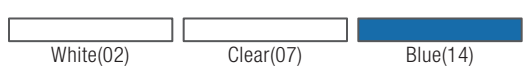

Prod No	Description	Color	Pack	Cs Wt/Cube
Scoops				
606040	38 oz Solid Cast Aluminum Scoop	—	12 ea	10.32/0.54
606055	58 oz Solid Cast Aluminum Scoop	—	12 ea	19.87/0.74
606086	85 oz Solid Cast Aluminum Scoop	—	12 ea	20.76/1.15
4306 Δ	6 oz Polycarbonate Scoop	07	12 ea	2.60/0.33
4332 Δ	32 oz Polycarbonate Scoop	07	12 ea	5.15/0.82
4364 Δ	64 oz Polycarbonate Scoop	07	6 ea	4.05/0.84
IceMaster Ice Transport Tote & Accessories				
12875 Δ	IceMaster Ice Transport	02	2 ea	7.50/2.64
12876	IceMaster Lid	14	1 ea	0.29/0.10
12877	IceMaster Wall Bracket	14	1 ea	0.11/0.01
Ice Only Container & Lid				
341010ICE Δ	10 gal Ice Only Container	02	6 ea	16.50/5.45
341011	10 gal Ice Only Container Lid	02	6 ea	5.50/0.77

NSF Listed products are designated with a Δ and may be prefixed with an N



SPARTA® PASTRY & BASTING BRUSHES

Sparta Pastry & Basting Brushes have been the **top choice** of discriminating professional chefs the world over for decades. The **high quality craftsmanship** provides the **best bristle retention in the industry**. You should never sacrifice food safety and with our wide selection of brushes, we have a brush to cover **all of your needs**.



Other Brands

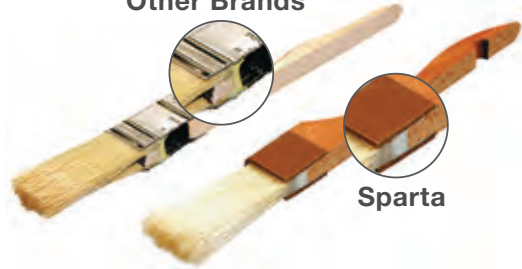

Sparta

Superior Food Safety Construction

Epoxy-set ferrules on all Sparta Pastry/Basting Brushes are especially designed for foodservice use; eliminating hazardous bacteria traps commonly found in other brushes. Sparta Pastry/Basting Brushes are available in a wide range of sizes and styles.

Chef Series™ Brushes

- Professional, high-quality lacquered hardwood handles with brown plastic ferrules are the choice of top chefs
- Bristles are epoxy-set to ferrules to provide superior bristle retention and to prevent bacteria harboring air pockets

Sparta Chef Series Croissant Brush

- Extra long bleached boar bristles for use on the most delicate of pastries and foods



Chef Series Basting Brushes

- The professional's choice for use in basting meats and poultry
- Durable sterilized, double-boiled, bleached boar bristles
- Withstands temperatures of up to 500°F

Note: Basting brushes should not be cleaned in dishwashers. Brushes should be dipped in a commercial cleaning solution and rinsed.



For usage information on these and other brushes included in our 21 Key Brushes Set, check out our 21 Key Brush Guide on pages 241-243



Standard(00)

Prod No	Description	Color	Pack	Cs Wt/Cube
Sparta Chef Series Croissant Brush				
40377	1.5" Wide Brush with Boar Bristles	00	12 ea	3.00/0.13
Sparta Chef Series Basting Brushes				
40370	12" Handle with 2" Wide Brush with Boar Bristles	00	12 ea	2.95/0.23
40371	12" Handle with 4" Wide Brush with Boar Bristles	00	12 ea	6.00/0.65
40372	1" Wide Flat Brush with Boar Bristles	00	12 ea	1.00/0.05
40373	1.5" Wide Flat Brush with Boar Bristles	00	12 ea	1.36/0.05
40374	2" Wide Flat Brush with Boar Bristles	00	12 ea	1.75/0.08
40375	3" Wide Flat Brush with Boar Bristles	00	12 ea	3.10/0.17
40376	4" Wide Flat Brush with Boar Bristles	00	12 ea	4.65/0.23
40380	1" Round Brush with Boar Bristles	00	12 ea	2.26/0.13



Chef Series Pastry Brushes

- Soft, flagged, white nylon bristles have high fluid retaining capacity and provide a soft touch to delicate pastries
- The finest commercial brushes of their kind
- Offers the performance, delicate touch, and long-lasting value by which all others are judged



Meteor Pastry/Basting Brushes

- “Molded-into-the-handle” hook hangs on lip of crocks and containers to prevent bristle burn, melt, or distortion
- Use hook to elevate bristles off of counter tops
- Soft flagged bristles are molded into handle to prevent bacteria harboring air pockets
- Available with white nylon bristles or double-boiled, bleached, sterilized, premium boar bristles

Hook hangs on side of crock or elevates bristles off counter tops



Bristles | Heat Distortion Point

Synthetic	Up to 350°F (176.7°C)
Boar	500°F (260°C)
Silicone	500°F (260°C)

White(02)	Blue(14)
-----------	----------

Prod No	Description	Color	Pack	Cs Wt/Cube
Sparta Chef Series Pastry Brushes				
40395	1" Wide Brush with Nylon Bristles	—	12 ea	1.06/0.05
40396	1.5" Wide Brush with Nylon Bristles	—	12 ea	1.36/0.05
40397	2" Wide Brush with Nylon Bristles	—	12 ea	1.70/0.08
40398	3" Wide Brush with Nylon Bristles	—	12 ea	2.90/0.17
40399	4" Wide Brush with Nylon Bristles	—	12 ea	4.36/0.23
40400	1" Round Brush with Nylon Bristles	—	12 ea	2.15/0.13
Sparta Meteor Pastry/Basting Brushes				
40378	2" Wide Brush with Boar Bristles	—	12 ea	1.96/0.13
40379	3" Wide Brush with Boar Bristles	—	12 ea	2.50/0.17
40401	2" Wide Brush with Nylon Bristles	02, 14	12 ea	2.00/0.13
40402	3" Wide Brush with Nylon Bristles	02, 14	12 ea	9.00/0.76



SPARTA® PASTRY & BASTING BRUSHES

Galaxy™ Pastry Brushes

- Bristles are epoxy-set to prevent bacteria harboring air pockets
- One piece plastic handles are easy to clean
- Available with soft flagged nylon bristles
- Select brushes also available with blue nylon bristles for added contrast in working with white frostings or other white foods



Silicone Basting Brush

- Dishwasher safe
- Unique bristle design carries and spreads liquid better than ordinary Silicone basting brushes
- Withstands temperatures up to 500°F
- Convenient molded-in hanging hook grabs pan edges to keep brush from sliding in
- Stain and odor resistant



Prod No	Description	Color	Pack	Cs Wt/Cube
Sparta Galaxy Pastry Brushes				
40390	1.5" Wide Flat Brush with Nylon Bristles	02	12 ea	1.00/0.05
40391	2" Wide Flat Brush with Nylon Bristles	02, 14	12 ea	1.50/0.13
40392	3" Wide Flat Brush with Nylon Bristles	02, 14	12 ea	1.90/0.13
40393	4" Wide Flat Brush with Nylon Bristles	02, 14	12 ea	2.90/0.16
40394	1" Round Brush with Nylon Bristles	02	12 ea	2.00/0.10
Silicone Basting Brushes				
40403	2" Silicone Basting Brush	05	12 ea	2.00/0.13
40405	3" Silicone Basting Brush	05	12 ea	2.00/0.13



Food Preparation Brushes

Potato Brush

- Patented brush has stiff polyester bristles for aggressive cleaning along with a unique “scraper edge” grip for removing hard to reach blemishes on potatoes and other firm vegetables



Vegetable Brush

- Round loop construction, straight handle with firm bristles



Portioning Cups

- Scoop or transfer ice, liquids, or any bulk item
- Features flat sides for efficient scooping on the bottom of bins, food pans, or other storage containers
- Made of durable, break-resistant polycarbonate
- Unique U-shaped handle helps keep hands away from food contact areas while scooping
- Sizes are color coded for quick and easy identification
- NSF Listed; dishwasher safe



One Gallon Container

- Ideal for mixing batters, dressings, and drinks
- Assorted color toggle lids allow easy access for quick open and close action and color identification
- Tight sealing lid protects against spills
- Durable translucent polypropylene material makes it easy to see contents
- U.S. and metric measurements printed on side panels
- NSF Listed; dishwasher safe

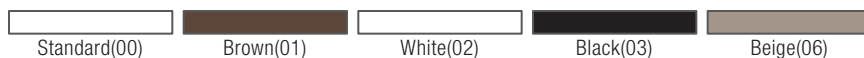

Prod No	Description	Color	Pack	Cs Wt/Cube
Sparta Food Preparation Brushes				
40412	5.75" Potato Brush with Medium Stiff Polyester Bristles	02	12 ea	3.00/0.17
40164	9.5" Vegetable Brush with Stiff Polyester Bristles	02	12 ea	2.68/0.32
Portioning Cups				
49110-1 Δ	9.5 oz Portion Cup	02	6 ea	1.56/0.17
49112-1 Δ	12 oz Portion Cup	06	6 ea	1.88/0.19
49116-1 Δ	16 oz Portion Cup	01	6 ea	2.27/0.25
49122-1 Δ	20 oz Portion Cup	03	6 ea	2.39/0.28
One Gallon Container & Toggles				
6400 Δ	1 Gallon Container	00	2 ea	3.08/0.54
6401 Δ	Replacement Lid & Assorted Toggles	00	6 ea	0.96/0.05

NSF Listed products are designated with a Δ and may be prefixed with an N



MEASURES & SERVING ACCESSORIES

Commercial Measures

- Made of durable polycarbonate
- Offers easy measuring of wet ingredients
- Available in Cup, Pint, Quart, Half Gallon and Gallon sizes with U.S. and metric measurements
- Oval shape facilitates pouring from non-spouted side
- Family of measures nest for storage
- NSF Listed; dishwasher safe

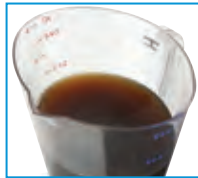

Overhead view of inside measuring lines allow for a faster, more accurate measurement.



Chef Series™ Measuring Cups & Spoons

- Extra-heavy-duty construction for the most demanding professional use
- Rust-free 18-8 stainless



Measuring Cup

- Durable polycarbonate with 1-cup capacity for measuring liquid ingredients
- Withstands temperatures from -40° to 212°F
- Dishwasher safe

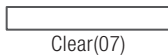

Prod No	Description	Color	Pack	Cs Wt/Cube
Commercial Measures				
43141 ▲	Cup Size PC Measure	07	12 ea	2.82/0.33
43142 ▲	Pint Size PC Measure	07	6 ea	2.30/0.33
43143 ▲	Quart Size PC Measure	07	6 ea	3.15/0.55
43144 ▲	Half Gallon Size PC Measure	07	6 ea	4.25/1.17
43145 ▲	Gallon Size PC Measure	07	6 ea	5.87/2.05
Chef Series Measuring Cups & Spoons				
604310	Chef Series Heavy-Weight Measuring Cup Set	—	12 ea	6.80/0.31
604300	Chef Series Heavy-Weight Measuring Spoons Set	—	12 ea	2.20/0.04
Measuring Cup				
4315	Measuring Cup	07	6 ea	1.50/0.17

NSF Listed products are designated with a ▲ and may be prefixed with an N



Dishers

- Color-coded for easy identification and portion control
- Smooth operating 18-8 stainless steel construction with ribbed plastic handle
- Bowl capacity is stamped on bail
- Number on bail indicates scoops per quart
- NSF Listed; dishwasher safe



Stainless Steel Measure Misers®

- Portion control spoons in heavy gauge 18-8 stainless steel with durable one-piece construction
- Feature color-coded Kool-Touch handles and built-in pan edge rest
- NSF Listed; dishwasher safe



Prod No	Description	Color	Pack	Cs Wt/Cube
Dishers				
60300-6 Δ	4.66 oz Disher with White Handle	—	12 ea	6.00/0.52
60300-8 Δ	4 oz Disher with Gray Handle	—	12 ea	6.00/0.52
60300-10 Δ	3.75 oz Disher with Ivory Handle	—	12 ea	6.00/0.52
60300-12 Δ	3.25 oz Disher with Green Handle	—	12 ea	6.00/0.52
60300-16 Δ	2.75 oz Disher with Blue Handle	—	12 ea	5.00/0.35
60300-20 Δ	2 oz Disher with Yellow Handle	—	12 ea	5.00/0.39
60300-24 Δ	1.75 oz Disher with Red Handle	—	12 ea	5.00/0.37
60300-30 Δ	1.25 oz Disher with Black handle	—	12 ea	5.00/0.35
60300-40 Δ	.88 oz Disher with Orchid handle	—	12 ea	5.00/0.35
Stainless Steel Measure Misers				
604358 Δ	1 oz Solid SS Measure Miser, Yellow	—	12 ea	3.58/0.19
604359 Δ	1 oz Perforated SS Measure Miser, Yellow	—	12 ea	3.58/0.19
604360 Δ	2 oz Solid SS Measure Miser, Red	—	12 ea	3.58/0.19
604361 Δ	2 oz Perforated SS Measure Miser, Red	—	12 ea	3.58/0.18
604370 Δ	3 oz Solid SS Measure Miser, Beige	—	12 ea	3.95/0.18
604371 Δ	3 oz Perforated SS Measure Miser, Beige	—	12 ea	3.58/0.18
604380 Δ	4 oz Solid SS Measure Miser, Green	—	12 ea	4.10/0.24
604381 Δ	4 oz Perforated SS Measure Miser, Green	—	12 ea	4.10/0.18
604390 Δ	6 oz Solid SS Measure Miser, Black	—	12 ea	4.75/0.26
604392 Δ	8 oz Solid SS Measure Miser, Blue	—	12 ea	5.25/0.30

NSF Listed products are designated with a Δ and may be prefixed with an N



MEASURE MISERS®

Measure Misers help your kitchen **deliver consistency** to make work easier and **save you money.**



Two year warranty against defects in materials and workmanship

Measure Misers

- Portion control spoon made of break-resistant polycarbonate
- Spoon's flat bottom easily spreads sauces or toppings
- Long handle measure misers have thumb grip for steady control and a notch for resting on pan rim
- Recommended for temperatures up to 212°F; withstands dry heat up to 270°F
- NSF Listed; dishwasher safe



Prod No	Description	Color	Pack	Cs Wt/Cube
Measure Misers				
Short Handle				
4322 Δ	1-1/2 oz, 7-3/16" Solid Measure Miser w/ Red Measurements	06	12 ea	1.25/0.19
4324 Δ	2 oz, 7-1/8" Solid Measure Miser w/ Red Measurements	06	12 ea	1.36/0.19
4362 Δ	2 oz, 7-1/8" Perforated Measure Miser w/ Red Measurements	06	12 ea	1.60/0.19
4326 Δ	3 oz, 8" Solid Measure Miser w/Blue Measurements	06	12 ea	1.50/0.28
4328 Δ	4 oz, 8-1/4" Solid Measure Miser w/ Green Measurements	06	12 ea	1.66/0.28
4329 Δ	4 oz, 8-1/4" Perforated Measure Miser w/ Green Measurements	06	12 ea	1.66/0.28
4330 Δ	6 oz, 8-5/8" Solid Measure Miser w/ Black Measurements	06	12 ea	1.90/0.28
Standard Handle				
4358 Δ	1-1/2 oz, 11-15/16" Solid Measure Miser w/ Maroon Measurements	06	12 ea	1.10/0.19
4360 Δ	2 oz, 11-15/16" Solid Measure Miser w/ Red Measurements	06	12 ea	1.70/0.19
4361 Δ	2 oz, 11-15/16" Perforated Measure Miser w/ Red Measurements	06	12 ea	1.60/0.19
4370 Δ	3 oz, 12-3/4" Solid Measure Miser w/ Blue Measurements	06	12 ea	1.94/0.28
4371 Δ	3 oz, 12-3/4" Perforated Measure Miser w/ Blue Measurements	06	12 ea	1.90/0.28
4380 Δ	4 oz, 13" Solid Measure Miser w/ Green Measurements	06	12 ea	2.10/0.28
4381 Δ	4 oz, 13" Perforated Measure Miser w/ Green Measurements	06	12 ea	2.15/0.28
4390 Δ	6 oz, 13-3/8" Solid Measure Miser w/ Black Measurements	06	12 ea	2.09/0.28
4391 Δ	6 oz, 13-3/8" Perforated Measure Miser w/ Black Measurements	06	12 ea	2.22/0.28
Black Measure Misers*				
4360-5 Δ	2 oz, 11-15/16" Solid Measure Miser	03	12 ea	1.70/0.19
4370-5 Δ	3 oz, 12-3/4" Solid Measure Miser	03	12 ea	1.94/0.28
4380-5 Δ	4 oz, 13" Solid Measure Miser	03	12 ea	2.10/0.28
4381-5 Δ	4 oz, 13" Perforated Measure Miser	03	12 ea	2.15/0.28
4390-5 Δ	6 oz, 13-3/8" Solid Measure Miser	03	12 ea	2.09/0.28

NSF Listed products are designated with a Δ and may be prefixed with an N*
Black measure misers do not have color-coding



Long lasting acetal Color-Coded Measure Misers ensure employees **deliver the consistency** your customers expect without compromising durability.



Two year warranty against defects in materials and workmanship

Color-Coded Measure Misers®

- Portion control spoon made of break-resistant acetal material
- Each color represents a different size for easy recognition and consistency
- Spoon's flat bottom easily spreads sauces or toppings
- Long handle measure misers have thumb grip for steady control and a notch for resting on pan rim
- Recommended for temperatures up to 212°F; withstands dry heat up to 270°F
- BPA Free
- NSF Listed; dishwasher safe



Reddish Brown(01)	White(02)	Black(03)	Yellow(04)
Red(05)	Forest Green(08)	Blue(14)	Orange(24)

Prod No	Description	Color	Pack	Cs Wt/Cube
Color-Coded Measure Misers				
Short Handle				
4921 Δ	1 oz Solid Spoon	04	12 ea	1.30/0.19
4923 Δ	1 oz Perforated Spoon	04	12 ea	1.00/0.19
4922 Δ	1.5 oz Solid Spoon	01	12 ea	1.25/0.19
4961 Δ	1.5 oz Perforated Spoon	01	12 ea	1.50/0.18
4924 Δ	2 oz Solid Spoon	05	12 ea	1.36/0.19
4962 Δ	2 oz Perforated Spoon	05	12 ea	1.36/0.19
4925 Δ	2.5 oz Solid Spoon	24	12 ea	1.43/0.28
4963 Δ	2.5 oz Perforated Spoon	24	12 ea	2.00/0.28
4926 Δ	3 oz Solid Spoon	02	12 ea	1.50/0.28
4928 Δ	4 oz Solid Spoon	08	12 ea	1.66/0.28
4929 Δ	4 oz Perforated Spoon	08	12 ea	1.66/0.28
4930 Δ	6 oz Solid Spoon	03	12 ea	1.90/0.28
4931 Δ	8 oz Solid Spoon	14	12 ea	2.30/0.28
Long Handle				
3956 Δ	1 oz Solid Spoon	04	12 ea	1.30/0.19
3957 Δ	1 oz Perforated Spoon	04	12 ea	1.30/0.19
3958 Δ	1.5 oz Solid Spoon	01	12 ea	1.10/0.19
3959 Δ	1.5 oz Perforated Spoon	01	12 ea	1.10/0.19
3960 Δ	2 oz Solid Spoon	05	12 ea	1.70/0.19
3961 Δ	2 oz Perforated Spoon	05	12 ea	1.70/0.19
3970 Δ	3 oz Solid Spoon	02	12 ea	1.94/0.28
3971 Δ	3 oz Perforated Spoon	02	12 ea	1.90/0.28
3980 Δ	4 oz Solid Spoon	08	12 ea	2.10/0.28
3981 Δ	4 oz Perforated Spoon	08	12 ea	2.15/0.28
3990 Δ	6 oz Solid Spoon	03	12 ea	2.22/0.28
3991 Δ	6 oz Perforated Spoon	03	12 ea	2.22/0.28
3992 Δ	8 oz Solid Spoon	14	12 ea	2.33/0.28
3993 Δ	8 oz Perforated Spoon	14	12 ea	2.33/0.28

NSF Listed products are designated with a Δ and may be prefixed with an N



BOWLS, COLANDERS, & DREDGES

Classic Stainless Steel Mixing Bowls

- Flared rim forms an integral pour lip while adding extra strength
- Rust-free 24 gauge, 18-4 stainless steel
- Dishwasher safe

Colanders

- Seamless satin finish aluminum construction with rolled top edge for extra strength
- Sturdy handles are securely riveted on sides
- Available in extra heavy or standard gauge aluminum



Coldmaster® Batter Pan

- Coldmaster system eliminates the inconvenience and mess of ice and reduces the potential of bacterial growth
- Use for batter and dredging to make sure uncooked food is always below ServSafe® temperature
- 10 qt capacity accommodates standard size fry baskets
- Holds batter at or below the ServSafe® guidelines of 40°F for up to eight hours**

*ServSafe® is a registered trademark of the National Restaurant Association

**Temperature retention is based on Coldmaster being pre-frozen for a minimum of eight hours, then filled directly with pre-chilled foods. Testing was conducted under ambient room temperatures of 76°F.



White(02)

Prod No	Description	Color	Pack	Cs Wt/Cube
Classic Stainless Steel Mixing Bowls				
601405	5 qt Classic Stainless Steel Mixing Bowl	—	12 ea	9.20/0.48
601408	8 qt Classic Stainless Steel Mixing Bowl	—	12 ea	10.60/0.82
601413	13 qt Classic Stainless Steel Mixing Bowl	—	12 ea	24.00/1.26
601416	16 qt Classic Stainless Steel Mixing Bowl	—	12 ea	13.00/1.34
601420	20 qt Classic Stainless Steel Mixing Bowl	—	6 ea	16.50/1.62
Colanders				
60275	11 qt Heavy-Weight Colander	—	6 ea	30.00/2.37
60277	16 qt Heavy-Weight Colander	—	6 ea	34.00/3.56
60278	8 qt Standard Weight Colander	—	6 ea	14.00/1.82
60279	11 qt Standard Weight Colander	—	6 ea	18.40/2.84
60280	16 qt Standard Weight Colander	—	6 ea	22.20/3.38
Coldmaster Batter Pan				
CM1072 ▲	Cold Batter Pan	02	1 ea	10.15/0.90

NSF Listed products are designated with a ▲ and may be prefixed with an N



Melamine Mixing Bowls

- Heavy-duty melamine is safe for temperatures up to 212°F
- Bowls are break and stain-resistant
- Not recommended for microwave use
- Dishwasher safe



Spaghetti Strainers

- Heavy gauge aluminum strainer
- Riveted plated steel handle and front hook for resting on stock pot



Dredges/Powder Cans

- Heavy-duty seamless dredges in aluminum
- 18-8 mirror polish stainless with wide screw tops for easy filling
- Dishwasher safe



Shaker/Dredge

- Durable break-resistant polycarbonate shaker can be customized with your logo
- See pages 324-325 for custom imprinting information
- Additional lids can be purchased separately to accommodate different toppings



Prod No	Description	Color	Pack	Cs Wt/Cube
Melamine Mixing Bowls				
43744	1.5 qt, 8" Mixing Bowl	02, 92	12 ea	7.90/0.83
43743	3 qt, 9.75" Mixing Bowl	02, 92	12 ea	12.30/1.45
Spaghetti Strainer				
60830	10" Spaghetti Strainer	—	12 ea	17.00/1.84
Metal Dredges/Powder Cans				
6030	Alumilite No Handle Dredge	—	12 ea	3.00/0.29
6031	Alumilite Dredge with Handle	—	12 ea	3.00/0.29
607531	Stainless Steel Dredge with Handle	—	12 ea	3.00/0.22
Polycarbonate Shaker/Dredge & Lids				
4250	Dredge with Medium Ground, Rose Lid	55	12 ea	3.10/0.32
4260	Dredge with Cheese, Yellow Lid	04	12 ea	3.10/0.32
4270	Dredge with Salt & Pepper, Beige Lid	06	12 ea	3.10/0.32
4230	Dredge with Translucent Parsley Lid	30	12 ea	2.50/0.32
4231	Translucent Parsley Lid	30	12 ea	0.50/0.06
4251	Rose Medium Ground Lid	55	12 ea	0.40/0.05
4261	Yellow Cheese Lid	04	12 ea	0.40/0.05
4271	Beige Salt & Pepper Lid	06	12 ea	0.40/0.05

NSF Listed products are designated with a **Δ** and may be prefixed with an N



TONGS, SKIMMERS, & LADLES

Tongs

Heavy-Duty Utility Tongs

- Heavy 20 gauge stainless steel with flat spring for long-lasting service
- Dishwasher safe

Spectrum® Dura-Kool™ Tongs

- Color-coded Dura-Kool handles provide easy visual for zone isolation
- Single-piece, heavy-duty stainless steel construction eliminates food traps for more sanitary use
- Spring action hinge won't break, also provides convenient hook for storage

Carlisle's Spectrum System supports your HACCP program by promoting zone isolation and reducing the risk of cross-contamination with our complete offering of color-coded kitchen tools and cleaning accessories



Wire Mesh Skimmers

- Heavy-duty construction
- Skimmers lift food from fryer
- Sturdy handles with hanging loops
- Nickel plated construction resists corrosion



Prod No	Description	Color	Pack	Cs Wt/Cube
Heavy-Duty Utility Tongs				
607550	9.5" Heavy-Duty Utility Tongs	—	12 ea	5.00/0.11
607552	12" Heavy-Duty Utility Tongs	—	12 ea	6.00/0.13
607556	16" Heavy-Duty Utility Tongs	—	12 ea	7.00/0.17
Spectrum Dura-Kool Tongs				
607560 Δ	9.5" Spectrum Dura-Kool Tong	03, 04, 05, 09, 14	12 ea	3.85/0.14
607562 Δ	12" Spectrum Dura-Kool Tong	03, 04, 05, 09, 14	12 ea	4.85/0.19
607566 Δ	16" Spectrum Dura-Kool Tong	03, 05, 09, 14	12 ea	7.45/0.26
Wire Mesh Skimmers				
601526	6" Bowl Mesh Skimmer	—	12 ea	10.00/0.72
601527	7" Bowl Mesh Skimmer	—	12 ea	11.00/0.72
601528	8" Bowl Mesh Skimmer	—	12 ea	12.00/1.56
601529	9" Bowl Mesh Skimmer	—	12 ea	13.00/2.29

NSF Listed products are designated with a Δ and may be prefixed with an N



Stainless Steel One-Piece Ladles

- Durable, one-piece, easy-cleaning construction
- Hooked handle is reinforced for extra strength
- Dishwasher safe



Stainless Steel One-Piece Ladle with High-Heat Handle

- Ergonomic design is perfect for self-service soup warmers
- Safety notch prevents ladle from slipping into pots or warmers
- Heat-resistant handle
- Dishwasher safe



Prod No	Description	Pack	Cs Wt/Cube
Stainless Steel One-Piece Ladles			
607351	1 oz One-Piece Ladle	12 ea	2.00/0.07
607352	2 oz One-Piece Ladle	12 ea	3.00/0.10
607353	3 oz One-Piece Ladle	12 ea	3.00/0.09
607354	4 oz One-Piece Ladle	12 ea	3.00/0.16
607356	6 oz One-Piece Ladle	12 ea	5.00/0.22
607358	8 oz One-Piece Ladle	12 ea	6.00/0.24
607362	12 oz One-Piece Ladle	12 ea	7.00/0.29
Stainless Steel One-Piece Ladle with High-Heat Handle			
607376	6 oz One-Piece Ladle with High-Heat Handle	12 ea	7.00/0.27



SPATULAS & SCRAPERS

Sparta® Spatulas & Paddle Scrapers

- Perfect for general mixing and stirring
- Long handle versions are ideal for vats and large pots
- Stainless steel or nylon/polyethylene scraper available
- Smooth finish, water-proof construction for easy clean-up
- Replacement blades are available for this product



Prod No	Description	Color	Pack	Cs Wt/Cube
Sparta Spatulas & Paddle Scrapers				
40347 ▲	36" Stainless Steel Paddle Scraper	—	6 ea	13.75/0.55
40349 ▲	48" Stainless Steel Paddle Scraper	—	6 ea	14.00/0.63
40359 ▲	60" Stainless Steel Paddle Scraper	—	6 ea	18.60/0.88
40350	13.5" Nylon Handle with 4.5" x 7.5" Nylon Spatula Scraper	02	6 ea	2.75/0.23
40351	13.5" Nylon Handle with 4.5" x 7.5" Polyethylene Soft Spatula Scraper	00	6 ea	2.65/0.23
40352	40" Nylon Handle with 4.5" x 7.5" Nylon Paddle Scraper	02	6 ea	7.00/0.55
40353	48" Nylon Handle with 4.5" x 7.5" Nylon Paddle Scraper	00	6 ea	11.00/0.76
40354	48" Stainless Steel Handle with 4.5" x 7.5" Nylon Paddle Scraper	00	6 ea	15.30/0.76
40355	72" Stainless Steel Handle with 4.5" x 7.5" Nylon Paddle Scraper	00	6 ea	45.00/0.28
40356	48" Stainless Steel Handle with 6.5" x 9" Nylon Paddle Scraper	00	3 ea	8.60/0.76
40361	4.5" x 7" Standard Nylon Replacement Blade	02	6 ea	1.50/0.10
40362	6.5" x 9" Large Nylon Replacement Blade	00	6 ea	2.00/0.16

NSF Listed products are designated with a ▲ and may be prefixed with an N



Spatulas & Scrapers

- Completely eliminate unsanitary food traps with the over-molded blade and handle design
- Fine-edge tapered profile of the spatula is perfect for spreading
- Sharp edge and deep bowl of the Scraper reduces waste by helping you scoop out every last drop
- Red handled high-heat versions are rated to 600°F and feature cool-touch handles

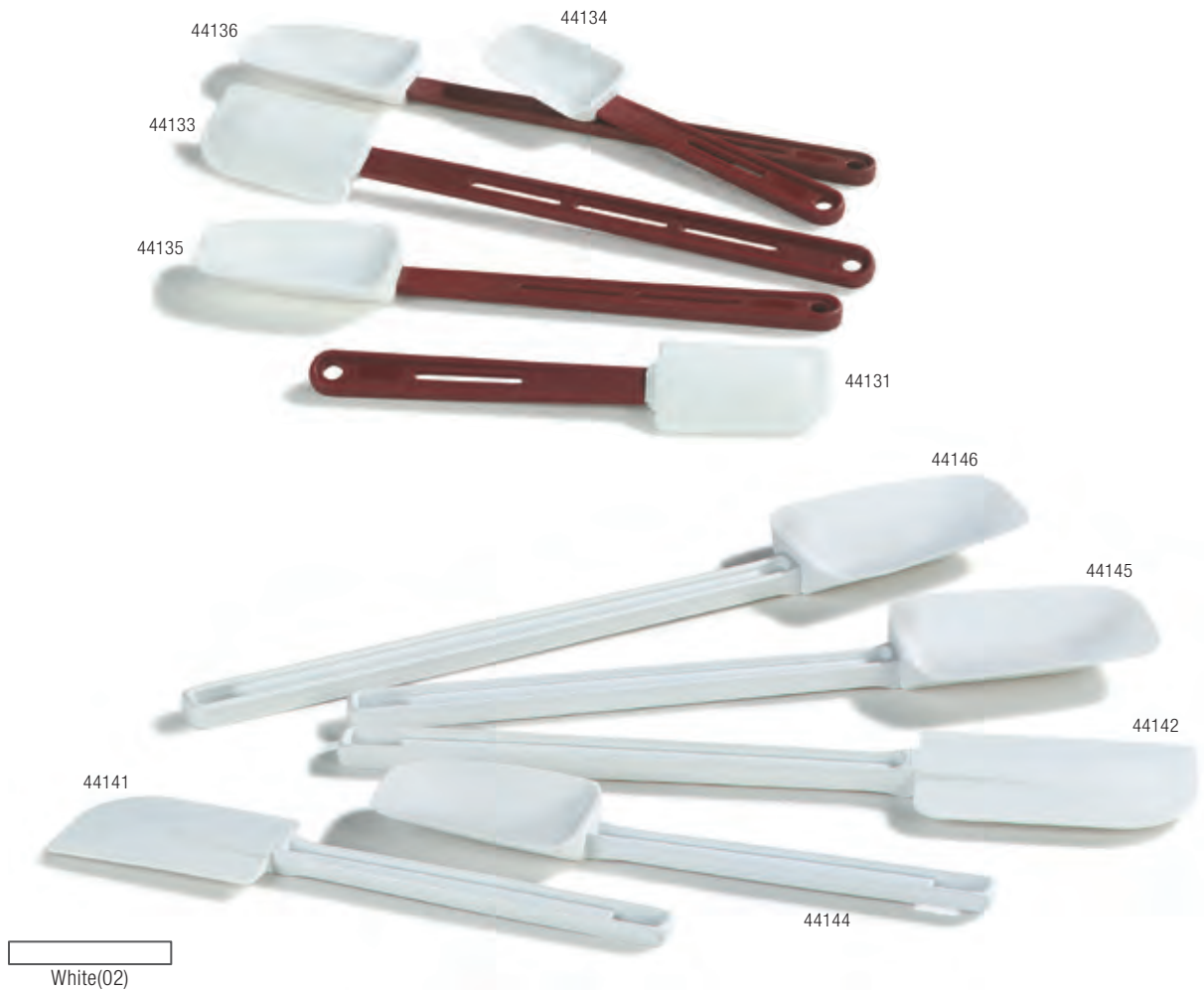

Prod No	Description	Color	Pack	Cs Wt/Cube
Spatulas & Scrapers				
44141	10" Spatula	02	12 ea	1.50/0.14
44142	14" Spatula	02	12 ea	1.50/0.14
44143	16" Spatula	02	12 ea	1.50/0.14
44144	10" Scraper	02	12 ea	1.50/0.14
44145	14" Scraper	02	12 ea	1.50/0.14
44146	16" Scraper	02	12 ea	1.50/0.14
44131	10.5" High Heat Spatula	02	12 ea	1.50/0.14
44132	14" High Heat Spatula	02	12 ea	1.50/0.14
44133	16.25" High Heat Spatula	02	12 ea	1.50/0.14
44134	10.5" High Heat Scraper	02	12 ea	1.50/0.14
44135	14" High Heat Scraper	02	12 ea	1.50/0.14
44136	16.25" High Heat Scraper	02	12 ea	1.50/0.14



SPOONS, WHIPS, & TOOLS

High Heat Serving Spoons & Turner

- High heat material withstands temperatures from -40° to 375°F without melting or transferring heat
- Helps prevent scratching on coated surfaces
- Notched handle with hole for hanging
- NSF Listed; dishwasher safe



High Heat Serving Spoons

- Notched handle allows spoon to rest on edge of food pan



Stainless Steel Serving Spoons

- Heavy-duty 18 gauge serving spoons are made of 18-8 stainless steel for long-lasting service
- Reinforced handle for extra strength with convenient hole for hanging
- Dishwasher safe



Sparta® Chef Series™ French Whips

- Sanitary fully-sealed construction eliminates bacteria harboring food traps
- Rust-free 18-8 stainless construction with heavy gauge spring wire loops
- Perfectly weighted and balanced for heavy mixing, stirring, and beating batters, sauces, and other thicker mixtures



Prod No	Description	Color	Pack	Cs Wt/Cube
High Heat Serving Spoons & Turner				
4415 ▲	11" Solid High Heat Serving Spoon	03	12 ea	1.50/0.14
4416 ▲	11" Perforated High Heat Serving Spoon	03	12 ea	1.50/0.14
4425 ▲	13" Solid High Heat Serving Spoon	03	12 ea	1.73/0.16
4426 ▲	13" Perforated High Heat Serving Spoon	03	12 ea	1.70/0.16
4900 ▲	13" Slotted Turner	03	12 ea	2.75/0.17
Stainless Steel Serving Spoons				
607813	13" Solid Spoon	—	12 ea	3.00/0.10
607815	15" Solid Spoon	—	12 ea	3.00/0.13
607813P	13" Perforated Spoon	—	12 ea	3.00/0.10
607815P	15" Perforated Spoon	—	12 ea	3.00/0.13
607813S	13" Slotted Spoon	—	12 ea	3.00/0.10
607815S	15" Slotted Spoon	—	12 ea	3.00/0.13
Sparta Chef Series French Whips				
40683	18" Chef Series Heavy-Weight French Whip	—	2 ea	1.50/0.28
40681	36" Chef Series Heavy-Weight French Whip	—	2 ea	4.20/0.46
40682	48" Chef Series Heavy-Weight French Whip	—	2 ea	5.14/0.60

NSF Listed products are designated with a ▲ and may be prefixed with an N



Oil Bottle & Sprayer

- 16 oz capacity to keep oil fresh
- Amber color protects light sensitive oils
- Value alternative to aerosol cans of oil
- Pre-labeled to ensure segregation from cleaning bottles
- Thread is compatible with standard sprayers

NEW PRODUCT



Sprayer (sold separately)

- Uniform spray density for even oil distribution
- Adjustable from spray to mist
- Metered application reduces food waste and improves consistency

Steak Weight

- Heavy iron weight transfers heat to speed cooking and brown evenly



Stainless Steel Peeler

- Peeler has swivel action stainless steel blade
- Tip can be used for coring and scraping



Timer

- Long ringing timer
- Made of sturdy plastic



Sparta® Foodservice Shovels

- Heavy duty one-piece plastic construction
- Supports heavy loads, safe to use with food, will not rust, and cleans up easily



Prod No	Description	Color	Pack	Cs Wt/Cube
Oil Bottle & Sprayer				
3816	16 oz Amber Bottle with Label	13	12 ea	1.65/0.49
3817	Trigger Sprayer	00	12 ea	1.15/0.12
Steak Weight				
607410	Cast Iron Steak Weight	—	12 ea	24.00/1.04
Stainless Steel Peeler				
6020	Peeler with Stainless Steel Blade	—	6 ea	1.00/1.56
Timer				
60300	One Hour Timer	—	12 ea	6.00/0.88
Sparta Foodservice Shovels				
41076-1	11" Wide Foodservice Shovel	02	1 ea	4.20/3.16
41077-1	14" Wide Foodservice Shovel	02	1 ea	5.80/2.74



CARLISLE
FOODSERVICE PRODUCTS

20L — 22 qt.
20L — 20 qt.
15L — 16 qt.
10L — 12 qt.
8 qt.

6L — 6 QT
4L — 4 QT
2L — 2 QT

1.5L — 2 QT
1L — 1 QT
3.0L — 3 QT
2.0L — 2 QT
1.0L — 1 QT

TOUGH VERSATILE SAFE INNOVATIVE **STORAGE & HANDLING SUPPLIES**

From distinct color-coding to easy-clean surfaces, Carlisle ensures that all of our products are designed to safely store, handle and transport food. You can count on Carlisle to help you keep food fresh, reduce food safety risks, reduce waste, and operate efficiently



STORPLUS™

COMPLETE STORAGE SOLUTIONS

Only Carlisle offers such a wide selection of storage containers for your foodservice operation.

All StorPlus products offer the quality construction and ease of use Carlisle is known for. They are tough and durable, plus these NSF Listed products are designed to support your HACCP program. Product features are detailed in this catalog section.



Food Pans, Lids & Accessories

Polycarbonate, BPA Free High Heat,
BPA Free Polypropylene



Coldmaster®

Innovative products that are a perfect compliment to your StorPlus containers

See pages 96-99 for a complete listing



Smart Lids

Easy transporting without spills

See pages 204-207 for a complete listing



Specialty Handled High Heat

Help products stay warm and fresh for your customers

See pages 209 for a complete listing





6" Deep 1/9 Size

Offer A **50% Larger** Assortment
With **35% Less** Footprint



Storage Boxes & Lids

Color-Coded For All Your Storage Needs



Squares & Rounds

Easy-To-Read **Capacity Indicators**
Built-In Handles

4 Options

**Only Carlisle Offers Four
Food Pan Options**

Polycarbonate, High Heat,
Polypropylene, Stainless





STORPLUS™ FOOD PANS

StorPlus is a whole house storage and handling solution. It provides **safety** and **efficiency**. The Universal Food Pan Lids fit all major brands, helping to **lower inventory**. Use these products that only Carlisle offers and **make work easy**.

Food Pans

- Reinforced top and bottom corners on both pan and lid help prevent chipping and cracking
- Spoonable bottom makes removal of contents easier and helps prevent food waste
- Molded-in capacity indicators are listed in both quarts and liters
- Textured non-slip finish on corners, sides, bottom, and lid to reduce scratches
- Smooth interior finish makes clean-up easy
- Polycarbonate containers can withstand temperatures from -40°F to 212°F
- High-heat pans excel in high temperature applications and are BPA Free (-40°F to 375°F)
- Polypropylene pans are an economical choice and BPA free (32°F to 170°F)
- Food Pan sizes meet specifications for use in food bars and steam tables
- Pans meet EN 631-1 Euro Norm standards for inter-stacking with existing pans
- NSF Listed; dishwasher safe



Universal Food Pan Lids

- Fit Carlisle StorPlus Food Pans as well as other major brands on the market
- Features a hanging hole for easy storage
- Fits both Gastronorm and standard size food pans
- Carlisle lids stack with themselves for easy storage
- Available in polycarbonate or high heat material
- NSF Listed; dishwasher safe



Smart Lids™

- Unique inside seal design provides superior leak-resistance and keeps your foods fresher, longer
- Perfect for transporting foods to off site locations
- Smart Lids (combined with StorPlus Food Pans) fit inside Cateraide Top Loaders and End Loaders (shown on pages 154-161)
- Polyethylene material is dishwasher safe; for use in -40°F to 180°F
- Designed exclusively to fit StorPlus Food Pans

Smart Lid's unique inside seal design provides superior leak-resistance; protects against spills





High Heat

StorPlus High Heat Food Pans provide the single container solution for cold storage, flash-freezing, microwave preheat/cooking, and prolonged high temperature retention in steam table applications.



6" Deep

Perfect for your toppings bar! 1/9 size food pans allow you a 50% larger assortment over 1/4 size pans. These pans have a similar capacity to our 4" deep 1/4 size food pans with 35% less footprint.



Catering

StorPlus Food Pans fit Carlisle Cateraides™ (see pages 152-161) and other standard transport containers for off site catering, company lunches, etc.

Use StorPlus Food Pans with Maximizer™, Six★Star™, and Five★Star™ Food Bars shown on pages 106-109 and with Cateraides shown on pages 154-161

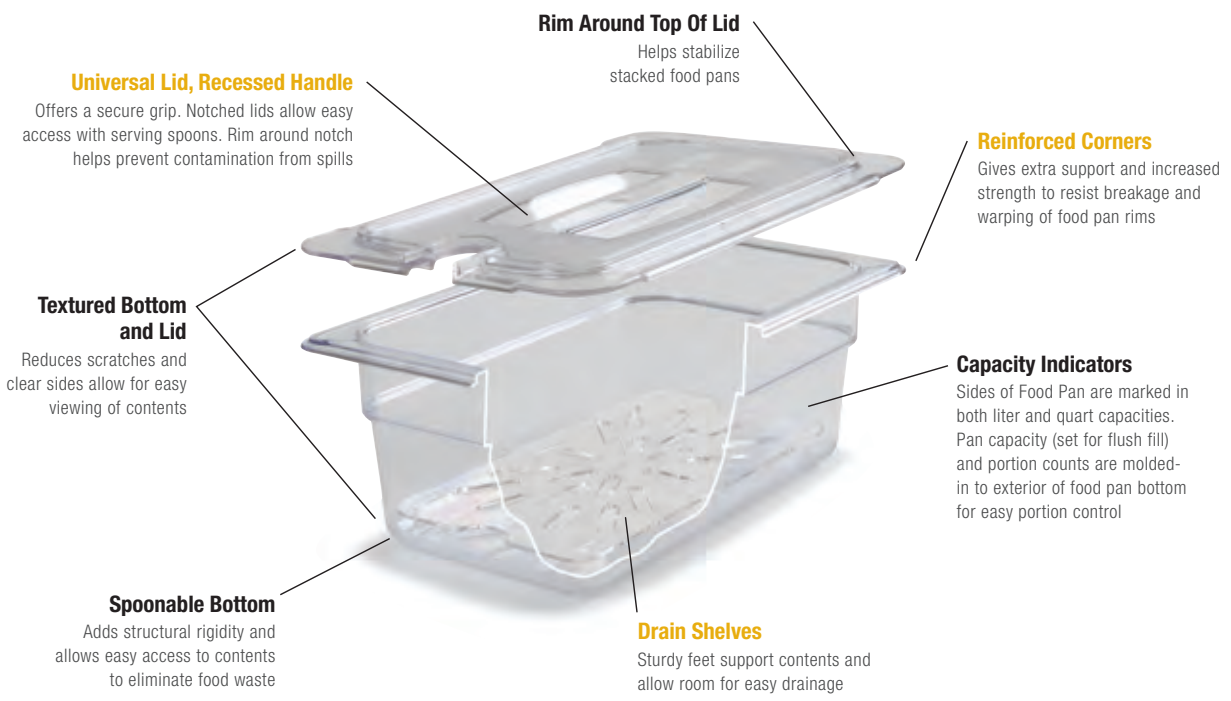



STORPLUS™ FOOD PANS

**NEW
PRODUCT**

Polycarbonate Food Pans & Lids

- Polycarbonate pans and lids withstand tough use
- Resists food acids and oils; and can withstand temperatures of -40°F to 212°F
- For a leak-resistant seal use Smart Lids

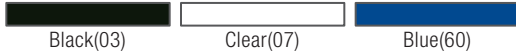

Prod No	Description	Color	Pack	Cs Wt/ Cube
Full-Size – 20.75" x 12.75"				
10200B Δ	Pan – 2.5" (7.6 qt)	03, 07	6 ea	10.70/1.16
10201B Δ	Pan – 4" (12.7 qt)	03, 07	6 ea	14.30/1.84
10202B Δ	Pan – 6" (19.4 qt)	03, 07	6 ea	17.60/2.41
10203B Δ	Pan – 8" (25.9 qt)	03, 07	6 ea	19.50/3.42
10215 Δ	Drain Shelf	07	6 ea	6.15/0.34
Lids – Fits All Full-Size Pans				
10212B	Smart Lid	60	6 ea	7.00/0.59
10210U Δ	Handled Lid	07	6 ea	9.65/0.94
10211U Δ	Handled Notched Lid	07	6 ea	9.65/0.89
10216U Δ	Flat Lid	07	6 ea	9.10/0.59
10217U Δ	Flat Notched Lid	07	6 ea	9.10/0.59
One-Half Size – 12.75" x 10.38"				
10220B Δ	Pan – 2.5" (3.6 qt)	03, 07	6 ea	5.65/0.56
10221B Δ	Pan – 4" (5.6 qt)	03, 07	6 ea	7.60/0.89
10222B* Δ	Pan – 6" (8.7 qt)	03, 07	6 ea	9.50/1.27
10223B Δ	Pan – 8" (11.4 qt)	03, 07	6 ea	11.45/1.50
10235 Δ	Drain Shelf	07	6 ea	2.60/0.23
Lids – Fits All One-Half Size Pans				
10232B	Smart Lid	60	6 ea	3.50/0.30
10230U Δ	Handled Lid	07	6 ea	4.20/0.42
10231U Δ	Handled Notched Lid	07	6 ea	4.15/0.42
10236U Δ	Flat Lid	07	6 ea	4.40/0.30
10237U Δ	Flat Notched Lid	07	6 ea	4.40/0.30
One-Half Long Size – 20.75" x 6.25"				
10240B Δ	Pan – 2.5" (2.9 qt)	03, 07	6 ea	6.25/0.60
10241B Δ	Pan – 4" (5.1 qt)	03, 07	6 ea	7.95/0.94
Lids – Fits All One-Half Long Size Pans				
10250U Δ	Handled Lid	07	6 ea	4.50/0.56
10256U Δ	Flat Lid	07	6 ea	4.71/0.56
10257U Δ	Flat Notched Lid	07	6 ea	4.69/0.56
One-Third Size – 12.75" x 7"				
30660 Δ	Pan – 2.5" (2.4 qt)	03, 07	6 ea	4.45/0.46
30661 Δ	Pan – 4" (3.8 qt)	03, 07	6 ea	5.95/0.73
30662 Δ	Pan – 6" (5.7 qt)	03, 07	6 ea	7.15/0.88
30669 Δ	Pan – 8" (7.3 qt)	03, 07	6 ea	4.35/0.88
30670 Δ	Drain Shelf	07	6 ea	1.40/0.12

Prod No	Description	Color	Pack	Cs Wt/ Cube
Lids – Fits All One-Third Size Pans				
30580	Smart Lid	60	6 ea	2.00/0.20
10270U Δ	Handled Lid	07	6 ea	3.60/0.35
10271U Δ	Handled Notched Lid	07	6 ea	3.55/0.33
10276U Δ	Flat Lid	07	6 ea	3.00/0.21
10277U Δ	Flat Notched Lid	07	6 ea	3.00/0.21
One-Quarter Size – 10.25" x 6.38"				
30680 Δ	Pan – 2.5" (1.7 qt)	03, 07	6 ea	3.65/0.36
30681 Δ	Pan – 4" (2.8 qt)	03, 07	6 ea	4.65/0.55
30682 Δ	Pan – 6" (4.0 qt)	03, 07	6 ea	6.10/0.69
30695 Δ	Drain Shelf	07	6 ea	1.00/0.08
Lids – Fits All One-Quarter Size Pans				
30581	Smart Lid	60	6 ea	2.00/0.15
10290U Δ	Handled Lid	07	6 ea	2.45/0.25
10291U Δ	Handled Notched Lid	07	6 ea	2.35/0.25
10296U Δ	Flat Lid	07	6 ea	2.20/0.16
10297U Δ	Flat Notched Lid	07	6 ea	2.20/0.16
One-Sixth Size – 6.75" x 6.38"				
30683 Δ	Pan – 2.5" (1.1 qt)	03, 07	6 ea	2.35/0.26
30684 Δ	Pan – 4" (1.7 qt)	03, 07	6 ea	3.10/0.35
30685 Δ	Pan – 6" (2.5 qt)	03, 07	6 ea	3.80/0.45
30689 Δ	Drain Shelf	07	6 ea	1.00/0.42
Lids – Fits All One-Sixth Size Pans				
30582	Smart Lid	60	6 ea	1.00/0.12
10310U Δ	Handled Lid	07	6 ea	1.70/0.16
10311U Δ	Handled Notched Lid	07	6 ea	1.80/0.17
10316U Δ	Flat Lid	07	6 ea	1.60/0.10
10317U Δ	Flat Notched Lid	07	6 ea	1.60/0.10
One-Ninth Size – 6.75" x 4.25"				
30686 Δ	Pan – 2.5" (0.7 qt)	03, 07	6 ea	1.85/0.18
30687 Δ	Pan – 4" (1.0 qt)	03, 07	6 ea	1.85/0.22
30688 Δ	Pan – 6" (1.4 qt)	03, 07	6 ea	2.50/0.30
10335 Δ	Drain Shelf	07	6 ea	0.80/0.42
Lids – Fits All One-Ninth Size Pans				
30583	Smart Lid	60	6 ea	0.50/0.08
10336U Δ	Flat Lid	07	6 ea	1.05/0.07

NSF Listed products are designated with a Δ and may be prefixed with an N



High Heat Food Pans & Lids

- High heat pans excel in high temperature applications (-40°F to 375°F)
- For a leak-resistant seal use Smart Lids



Prod No	Description	Color	Pack	Cs Wt/ Cube
Full-Size – 20.75" x 12.75"				
10400B Δ	Pan – 2.5" (7.6 qt)	03, 13	6 ea	11.05/1.16
10401B Δ	Pan – 4" (12.7 qt)	03, 13	6 ea	15.00/1.84
10402B Δ	Pan – 6" (19.4 qt)	03, 13	6 ea	18.30/2.41
10415 Δ	Drain Shelf	13	6 ea	6.36/0.34
Lids – Fits All Full-Size Pans				
10212B	Smart Lid	60	6 ea	7.00/0.59
10410U Δ	Handled Lid	13	6 ea	10.92/0.94
10411U Δ	Handled Notched Lid	13	6 ea	10.57/0.89
10416U Δ	Flat Lid	13	6 ea	10.60/0.59
10417U Δ	Flat Notched Lid	13	6 ea	10.60/0.59
One-Half Size – 12.75" x 10.38"				
10420B Δ	Pan – 2.5" (3.6 qt)	03, 13	6 ea	5.90/0.57
10421B Δ	Pan – 4" (5.6 qt)	03, 13	6 ea	8.00/0.89
10422B Δ	Pan – 6" (8.7 qt)	03, 13	6 ea	9.95/1.27
10423B Δ	Pan – 8" (11.4 qt)	03, 13	6 ea	13.25/1.50
10435 Δ	Drain Shelf	13	6 ea	2.75/0.23
Lids – Fits All One-Half Size Pans				
10232B	Smart Lid	60	6 ea	3.50/0.30
10430U Δ	Handled Lid	13	6 ea	5.60/0.42
10431U Δ	Handled Notched Lid	13	6 ea	4.80/0.42
10436U Δ	Flat Lid	13	6 ea	5.10/0.30
10437U Δ	Flat Notched Lid	13	6 ea	5.10/0.30
One-Half Long Size – 20.75" x 6.25"				
10440B Δ	Pan – 2.5" (2.9 qt)	03, 13	6 ea	6.90/0.60
10441B Δ	Pan – 4" (5.1 qt)	03, 13	6 ea	7.15/0.94
Lids – Fits All One-Half Long Size Pans				
10450U Δ	Handled Lid	13	6 ea	4.95/0.56
10456U Δ	Flat Lid	13	6 ea	5.44/0.56
10457U Δ	Flat Notched Lid	13	6 ea	5.41/0.56
One-Third Size – 12.75" x 7"				
30860 Δ	Pan – 2.5" (2.4 qt)	03, 13	6 ea	4.65/0.46
30861 Δ	Pan – 4" (3.8 qt)	03, 13	6 ea	5.95/0.73
30862 Δ	Pan – 6" (5.7 qt)	03, 13	6 ea	7.50/0.89
30869 Δ	Pan – 8" (7.3 qt)	03, 13	6 ea	4.35/0.88
30870 Δ	Drain Shelf	13	6 ea	1.44/0.12

Prod No	Description	Color	Pack	Cs Wt/ Cube
Lids – Fits All One-Third Size Pans				
30580	Smart Lid	60	6 ea	2.00/0.20
10470U Δ	Handled Lid	13	6 ea	3.42/0.39
10471U Δ	Handled Notched Lid	13	6 ea	4.10/0.33
10476U Δ	Flat Lid	13	6 ea	3.50/0.21
10477U Δ	Flat Notched Lid	13	6 ea	3.50/0.21
One-Quarter Size – 10.25" x 6.38"				
30880 Δ	Pan – 2.5" (1.7 qt)	03, 13	6 ea	3.80/0.36
30881 Δ	Pan – 4" (2.8 qt)	03, 13	6 ea	4.75/0.55
30882 Δ	Pan – 6" (4.0 qt)	03, 13	6 ea	6.10/0.69
30895 Δ	Drain Shelf	13	6 ea	1.05/0.08
Lids – Fits All One-Quarter Size Pans				
30581	Smart Lid	60	6 ea	2.00/0.15
10490U Δ	Handled Lid	13	6 ea	2.65/0.25
10491U Δ	Handled Notched Lid	13	6 ea	2.65/0.25
10496U Δ	Flat Lid	13	6 ea	2.60/0.16
10497U Δ	Flat Notched Lid	13	6 ea	2.60/0.16
One-Sixth Size – 6.75" x 6.38"				
30883 Δ	Pan – 2.5" (1.1 qt)	03, 13	6 ea	2.31/0.26
30884 Δ	Pan – 4" (1.7 qt)	03, 13	6 ea	3.25/0.40
30885 Δ	Pan – 6" (2.5 qt)	03, 13	6 ea	4.05/0.45
30896 Δ	Drain Shelf	13	6 ea	1.00/0.11
Lids – Fits All One-Sixth Size Pans				
30582	Smart Lid	60	6 ea	1.00/0.12
10510U Δ	Handled Lid	13	6 ea	2.10/0.16
10511U Δ	Handled Notched Lid	13	6 ea	2.10/0.16
10516U Δ	Flat Lid	13	6 ea	1.80/0.10
10517U Δ	Flat Notched Lid	13	6 ea	1.80/0.10
One-Ninth Size – 6.75" x 4.25"				
30886 Δ	Pan – 2.5" (0.7 qt)	03, 13	6 ea	1.95/0.20
30887 Δ	Pan – 4" (1.0 qt)	03, 13	6 ea	2.45/0.26
30888 Δ	Pan – 6" (1.4 qt)	03, 13	6 ea	2.50/0.30
10535 Δ	Drain Shelf	13	6 ea	0.75/0.10
Lids – Fits All One-Ninth Size Pans				
30583	Smart Lid	60	6 ea	0.50/0.08
10536U Δ	Flat Lid	13	6 ea	0.97/0.07
10537U Δ	Flat Notched Lid	13	6 ea	0.97/0.07

NSF Listed products are designated with a Δ and may be prefixed with an N



STORPLUS™ FOOD PANS

Polypropylene Food Pans & Lids

- Polypropylene (PP) pans are a great low cost alternative to polycarbonate and are BPA-Free
- Translucent material offers contact clarity for easy identification of products
- Polypropylene material withstands temperatures from 32° to 170° F
- Optional Universal Style polypropylene lids are available

The perfect solution for cold holding applications and the cost-conscious users



Translucent(30)

Prod No	Description	Color	Pack	Cs Wt/Cube
Full-Size – 20.75" x 12.75"				
70200B Δ	Pan – 2.5" (7.6 qt)	30	6 ea	10.70/1.16
70201B Δ	Pan – 4" (12.7 qt)	30	6 ea	14.30/1.84
70202B Δ	Pan – 6" (19.4 qt)	30	6 ea	17.60/2.41
70215 Δ	Drain Shelf	30	6 ea	6.15/0.34
Lids – Fits All Full-Size Pans				
70210U Δ	Handled Lid	30	6 ea	9.65/0.94
70216U Δ	Flat Lid	30	6 ea	9.10/0.59
One-Half Size – 12.75" x 10.38"				
70220B Δ	Pan – 2.5" (3.6 qt)	30	6 ea	5.65/0.56
70221B Δ	Pan – 4" (5.6 qt)	30	6 ea	7.60/0.89
70222B Δ	Pan – 6" (8.7 qt)	30	6 ea	9.50/1.27
70235 Δ	Drain Shelf	30	6 ea	2.60/0.23
Lids – Fits All One-Half Size Pans				
70230U Δ	Handled Lid	30	6 ea	4.20/0.42
70236U Δ	Flat Lid	30	6 ea	4.40/0.30
One-Third Size – 12.75" x 7"				
70660 Δ	Pan – 2.5" (2.4 qt)	30	6 ea	4.45/0.46
70661 Δ	Pan – 4" (3.8 qt)	30	6 ea	5.95/0.73
70662 Δ	Pan – 6" (5.7 qt)	30	6 ea	7.15/0.88
70670 Δ	Drain Shelf	30	6 ea	1.40/0.12
Lids – Fits All One-Third Size Pans				
70270U Δ	Handled Lid	30	6 ea	3.60/0.35
70276U Δ	Flat Lid	30	6 ea	3.00/0.21
One-Sixth Size – 6.75" x 6.38"				
70683 Δ	Pan – 2.5" (1.1 qt)	30	6 ea	2.35/0.26
70684 Δ	Pan – 4" (1.7 qt)	30	6 ea	3.10/0.35
70685 Δ	Pan – 6" (2.5 qt)	30	6 ea	3.80/0.45
70689 Δ	Drain Shelf	30	6 ea	1.00/0.42
Lids – Fits All One-Sixth Size Pans				
70310U Δ	Handled Lid	30	6 ea	1.70/0.16
70316U Δ	Flat Lid	30	6 ea	1.60/0.10
One-Ninth Size – 6.75" x 4.25"				
70686 Δ	Pan – 2.5" (0.7 qt)	30	6 ea	1.85/0.18
70687 Δ	Pan – 4" (1.0 qt)	30	6 ea	2.30/0.22
70688 Δ	Pan – 6" (1.4 qt)	30	6 ea	2.50/0.30
70335 Δ	Drain Shelf	30	6 ea	0.80/0.42
Lids – Fits All One-Ninth Size Pans				
70336U Δ	Flat Lid	30	6 ea	1.05/0.07

NSF Listed products are designated with a Δ and may be prefixed with an N



Made specifically for **warming and holding cabinets**, our single- and double-handled pans help **products stay warm and fresh for your customers.**

Specialty High Heat Handled Pans

- Transports food safely from the oven to the warming unit
- Double handled pan is perfect for restaurants with “pass through” warming units
- Stain-, heat-, and impact- resistant high heat material
- Available in 2.5" and 4" depths
- NSF Listed; dishwasher safe

High Heat Pan Divider

Pair our high heat pan divider (30871) with our 1/3 x 2.5" deep handled pan (30860HH) to warm and hold multiple items in one pan while reducing the risk of foods touching; perfect for low volume meat or chicken items

- Use with 1/6 size drain shelf to help keep foods fresh



Amber(13)

Prod No	Description	Color	Pack	Cs Wt/Cube
Specialty High Heat Pans				
30860H Δ	1/3 Size 2.5" Deep with 1 Handle	13	6 ea	5.79/0.52
30860HH Δ	1/3 Size 2.5" Deep with 2 Handles	13	6 ea	6.10/0.71
30861H Δ	1/3 Size 4" Deep with 1 Handle	13	6 ea	5.70/0.72
30861HH Δ	1/3 Size 4" Deep with 2 Handles	13	6 ea	6.10/0.89
30871 Δ	1/6 Size 2.5" Deep Pan Divider	13	8 ea	3.00/0.43

NSF Listed products are designated with a Δ and may be prefixed with an N



STORPLUS™ STORAGE BOXES

StorPlus **color-coded** storage boxes are a solution that helps employees **easily identify** proper storage containers, **eliminating cross-contamination**.

StorPlus Color-Coded Storage Boxes & Lids

Food Storage Boxes

- Reinforced top and bottom corners on both box and lid, help prevent chipping and cracking
- Quart, gallon, and liter capacity indicators (on 12" x 18" box)
- StorPlus boxes stack easily for efficient storage, fit standard carts and racks, and with other boxes on the market
- Smooth interior surface makes cleaning easy
- "Lock-Tight" lids can be reversed and used as bun pan or tray
- Polycarbonate boxes provide easy visibility, superior resistance to food acids and oils, and withstands temperatures from -40°F to 212°F
- Boxes double as dough proofing bus boxes, warewashing tubs for kitchen overflow, or remote locations
- 18" x 26" colander is ideal for storing, draining, thawing, and marinating foods; keeps lettuce crisp, thaws and drains fish on ice, marinates chicken, etc.
- Polyethylene boxes offers economical storage and transport and withstands temperatures from -40°F to 180°F
- NSF Listed; dishwasher safe

Benefits of StorPlus Color-Coded Storage Boxes

- Prevent cross-contamination and help meet standards as part of a complete HACCP Program
- RimGlow™ technology gives the boxes and lids a distinct, yet transparent color to segregate them by usage

ServSafe® Recommended Stacking Order:



ServSafe® is a registered trademark of the National Restaurant Association



White(02)	Red(05)	Clear(07)	Green(09)	Blue(14)	Yellow(22)	
Prod No	Color	Prod No	Description	Color	Pack	Cs Wt/Cube
Clear Polycarbonate*		Color-Coded Polycarbonate				
10610 Δ	07		2 gal 12" x 18" x 3.5 Box		6 ea	10.85/1.11
10611 Δ	07	10611C Δ	3.5 gal 12" x 18" x 6" Box	05, 09, 14, 22	6 ea	15.45/2.12
10612 Δ	07	10612C Δ	5 gal 12" x 18" x 9" Box	05, 09, 14, 22	6 ea	19.50/2.82
10617 Δ	07	10617C Δ	12" x 18" Lid	05, 09, 14, 22	6 ea	7.85/0.49
10620 Δ	07	—	5 gal 18" x 26" x 3.5" Box		6 ea	23.40/2.38
10621 Δ	07	10621C Δ	8.5 gal 18" x 26" x 6" Box	05, 09, 14, 22	6 ea	31.70/4.63
10622 Δ	07	10622C Δ	12.5 gal 18" x 26" x 9" Box	05, 09, 14, 22	4 ea	27.25/4.70
10623 Δ	07	10623C Δ	16.6 gal 18" x 26" x 12" Box	05, 09, 14, 22	3 ea	27.40/5.07
10624 Δ	07	10624C Δ	21.5 gal 18" x 26" x 15" Box	05, 09, 14, 22	3 ea	31.75/7.17
10627 Δ	07	10627C Δ	18" x 26" Lid	05, 09, 14, 22	6 ea	14.50/1.13
10628 Δ	07	—	18" x 26" x 5" Colander		6 ea	27.50/2.55
10629 Δ	07	—	18" x 26" Drain Grate		6 ea	11.24/0.57

NSF Listed products are designated with a Δ and may be prefixed with an N

*Clear polycarbonate food boxes comes in Clear(07) only



White(02)

Prod No	Description	Color	Pack	Cs Wt/Cube
White Polyethylene				
10630 Δ	2 gal 12" x 18" x 3.5" Box	02	6 ea	8.40/1.11
10631 Δ	3.5 gal 12" x 18" x 6" Box	02	6 ea	12.20/2.16
10632 Δ	5 gal 12" x 18" x 9" Box	02	6 ea	15.35/2.82
10637 Δ	12" x 18" “Lock-Tight” Lid	02	6 ea	6.00/0.48
10640 Δ	5 gal 18" x 26" x 3.5" Box	02	6 ea	18.25/2.38
10641 Δ	8.5 gal 18" x 26" x 6" Box	02	6 ea	25.00/4.68
10642 Δ	12.5 gal 18" x 26" x 9" Box	02	4 ea	20.45/4.73
10643 Δ	16.6 gal 18" x 26" x 12" Box	02	3 ea	20.70/5.07
10644 Δ	21.5 gal 18" x 26" x 15" Box	02	3 ea	24.00/7.17
10647 Δ	18" x 26" “Lock-Tight” Lid	02	6 ea	12.10/1.13
10648 Δ	18" x 26" x 5" Colander	02	6 ea	21.30/2.55

NSF Listed products are designated with a Δ and may be prefixed with an N



STORPLUS™ STORAGE CONTAINERS

StorPlus storage containers are clear and have **tight fitting lids**, improving organization and **minimizing the risk** of cross contamination, **making work easier**.

Square Food Storage Containers

- Perfect for storing condiments, spices, toppings, leftover, or preparation
- Clear polycarbonate containers provide exceptional durability and can withstand temperatures from -40°F to 212°F
- Economical white polyethylene containers withstand temperatures from -40°F to 180°F
- Stackable with other popular brands
- Color-coded, textured snap-on lids fit both the polycarbonate and polyethylene containers
- Smooth interior finish makes clean up easy
- NSF Listed; dishwasher safe

Safe & Easy Lifting
Only Carlisle offers square storage containers in 1qt-8qt with handles on both sides

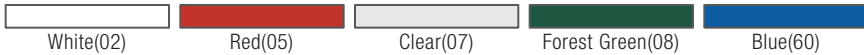

Prod No	Description	Color	Pack	Cs Wt/Cube
StorPlus Square Polycarbonate Food Storage Containers				
10720 Δ	2 qt, 7.13" Sq x 3.81" H Polycarbonate Container	07	6 ea	3.95/0.56
10721 Δ	4 qt, 7.13" Sq x 7.31" H Polycarbonate Container	07	6 ea	6.00/0.73
10722 Δ	6 qt, 8.75" Sq x 7.31" H Polycarbonate Container	07	6 ea	8.15/1.16
10723 Δ	8 qt, 8.75" Sq x 9" H Polycarbonate Container	07	6 ea	9.40/1.20
10724 Δ	12 qt, 11.13" Sq x 8.25" H Polycarbonate Container	07	6 ea	14.00/2.41
10725 Δ	18 qt, 11.13" Sq x 12.56" H Polycarbonate Container	07	6 ea	18.35/3.11
10726 Δ	22 qt, 11.13" Sq x 15.75" H Polycarbonate Container	07	6 ea	22.80/3.61
StorPlus Square Polyethylene Food Storage Containers				
10730 Δ	2 qt, 7.13" Sq x 3.81" H Polyethylene Container	02	6 ea	3.50/0.56
10731 Δ	4 qt, 7.13" Sq x 7.31" H Polyethylene Container	02	6 ea	5.40/0.73
10732 Δ	6 qt, 8.75" Sq x 7.31" H Polyethylene Container	02	6 ea	7.30/1.18
10733 Δ	8 qt, 8.75" Sq x 9" H Polyethylene Container	02	6 ea	8.40/1.23
10734 Δ	12 qt, 11.13" Sq x 8.25" H Polyethylene Container	02	6 ea	12.50/2.41
10735 Δ	18 qt, 11.13" Sq x 12.56" H Polyethylene Container	02	6 ea	16.50/3.11
10736 Δ	22 qt, 11.13" Sq x 15.75" H Polyethylene Container	02	6 ea	20.50/3.61
StorPlus Square Container Lids				
10740 Δ	2-4 qt, 7.31" Sq Lid	08	6 ea	1.30/0.13
10741 Δ	6-8 qt, 9" Sq Lid	05	6 ea	1.90/0.18
10742 Δ	12-18-22 qt, 11.38" Sq Lid	60	6 ea	2.90/0.28

NSF Listed products are designated with a Δ and may be prefixed with an N

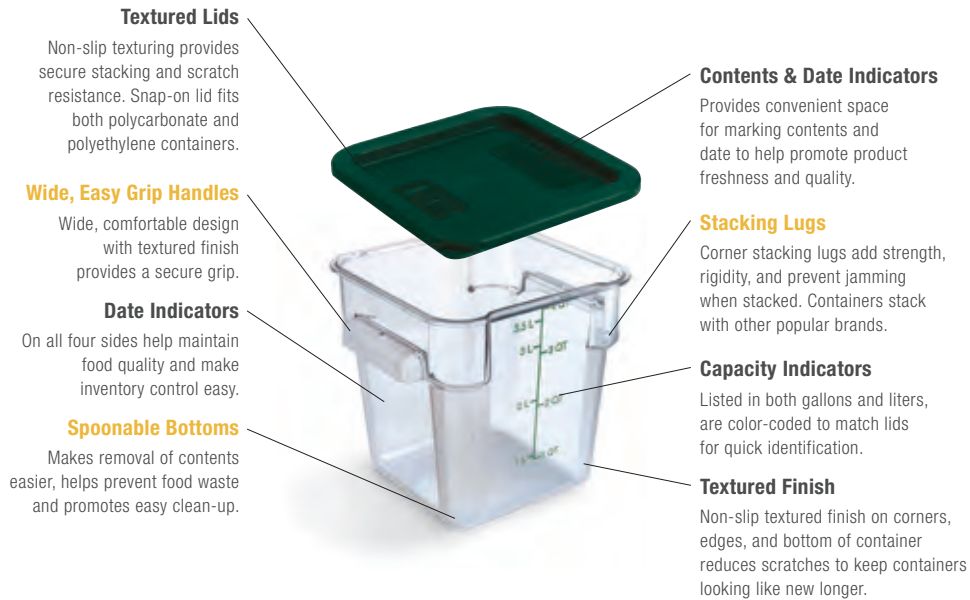

Economical Space Savers

- Clean, safe alternative to storing food in shipping cartons
- Square shape allows for practical storage in the freezer, cooler, or shelf
- Molded-in volume graduations indicate capacity
- Translucent polypropylene offers contact clarity for easy identification of products
- Withstand temperatures from 32°F to 170°F
- Economical white polyethylene withstands temperatures from -40°F to 180°F
- NSF Listed; dishwasher safe



Prod No	Description	Color	Pack	Cs Wt/Cube
Economical Polypropylene Space Savers				
ST1532 Δ	2 qt, 6.62" Sq x 4.12" H Polypropylene Container	30	12 ea	5.80/0.93
ST1544 Δ	4 qt, 6.62" Sq x 8.12" H Polypropylene Container	30	12 ea	9.46/1.18
ST1556 Δ	6 qt, 8.60" Sq x 6.87" H Polypropylene Container	30	12 ea	11.60/1.85
ST1568 Δ	8 qt, 8.60" Sq x 9.25" H Polypropylene Container	30	12 ea	13.90/2.05
ST1629 Δ	18 qt, 14.18" x 8.31" x 12.75" H Polypropylene Container	30	6 ea	10.40/1.78
Economical Polyethylene Space Savers				
1532 Δ	2 qt, 6.62" Sq x 4.12" H Polyethylene Container	02	12 ea	5.80/0.93
1544 Δ	4 qt, 6.62" Sq x 8.12" H Polyethylene Container	02	12 ea	9.25/1.18
1556 Δ	6 qt, 8.60" Sq x 8.12" H Polyethylene Container	02	12 ea	12.10/1.85
1568 Δ	8 qt, 8.60" Sq x 9.25" H Polyethylene Container	02	12 ea	14.70/2.05
1629 Δ	18 qt, 14.18" x 8.31" x 12.75" H Polyethylene Container	02	12 ea	11.10/1.78
Economical Space Saver Lids				
ST1573	2-4 qt, 6.62" Sq Lid	30	12 ea	1.45/0.11
ST1587	6-8 qt, 8.60" Sq Lid	30	12 ea	2.86/0.20
ST1630	18 qt, 14.37" Sq Lid	30	6 ea	2.80/0.23

NSF Listed products are designated with a Δ and may be prefixed with an N



STORPLUS™ STORAGE CONTAINERS

Round Food Storage Containers

- Super-tough, clear polycarbonate for ultimate durability allows easy food content identification at a glance
- StorPlus containers stack with other major brands for convenient storage; stacking shoulder prevents jamming
- Date indicator helps maintain food quality and control inventory turns, interchangeable with other brands
- Exclusive Carlisle spoonable bottom for increased yield and less food waste
- Clear polycarbonate containers can withstand temperatures from -40°F to 212°F
- NSF Listed; dishwasher safe



Prod No	Description	Color	Pack	Cs Wt/Cube
StorPlus Round Food Storage Containers				
10761 Δ	1 qt Round Container	07	12 ea	4.20/0.44
10763 Δ	2 qt Round Container	07	12 ea	6.56/0.67
10764 Δ	4 qt Round Container	07	12 ea	10.87/0.88
10765 Δ	6 qt Round Container	07	12 ea	12.17/1.31
10766 Δ	8 qt Round Container	07	12 ea	14.53/1.45
10767 Δ	12 qt Round Container	07	6 ea	11.24/1.74
10768 Δ	18 qt Round Container	07	6 ea	16.24/2.53
10769 Δ	22 qt Round Container	07	6 ea	20.93/3.23
StorPlus Round Container Lids				
10770 Δ	1 qt Round Lid	30	12 ea	0.40/0.18
10771 Δ	2-4 qt Round Lid	08	12 ea	2.40/0.39
10772 Δ	6-8 qt Round Lid	05	12 ea	3.27/0.43
10773 Δ	12-18-22 qt Round Lid	60	6 ea	3.49/0.46

NSF Listed products are designated with a Δ and may be prefixed with an N



Bains Maries

- Carlisle Bains Marie are the original round food storage containers
- Outside stacking lugs prevent jamming
- 12, 18, & 22 qt sizes have recessed handles for extra strength and stability in lifting, as well as graduated U.S. measurements shown on the side of the container
- 2, 3.5, 6, & 8 qt sizes can be imprinted
- Clear polypropylene containers are translucent and seamless, offering contact clarity for easy identification of products
- Polypropylene containers withstand temperatures from 32°F to 170°F
- Economical white polyethylene containers will withstand temperatures from -40°F to 180°F
- NSF Listed; dishwasher safe



Prod No	Description	Color	Pack	Cs Wt/Cube
Bains Marie Polypropylene Containers				
0205 Δ	2 qt Container, 6.56" D x 4.38" H	30	12 ea	5.02/0.71
0355 Δ	3.5 qt Container, 6.56" D x 7.63" H	30	12 ea	7.25/1.11
0605 Δ	6 qt Container, 7.63" D x 8.13" H	30	12 ea	9.35/2.34
0805 Δ	8 qt Container, 7.63" D x 10.75" H	30	12 ea	11.95/3.42
1205 Δ	12 qt Container, 12.25" D x 8.75" H	30	6 ea	8.78/2.24
1805 Δ	18 qt Container, 12.38" D x 13" H	30	6 ea	10.15/3.07
2205 Δ	22 qt Container, 12.25" D x 15.44" H	30	6 ea	12.92/4.20
Bains Marie Polypropylene Container Lids				
0202 Δ	2 – 3.5 qt Lid, 6.69" D x .31" H	30	12 ea	1.26/0.12
0602 Δ	6 – 8 qt Lid, 8.06" D x .38" H	30	12 ea	2.00/0.21
1252 Δ	12 – 18 – 22 qt Lid, 12.38" D x .75" H	30	6 ea	3.10/0.45
Bains Marie Polyethylene Containers				
0200 Δ	2 qt Container, 6.56" D x 4.44" H	02	12 ea	5.15/0.71
0350 Δ	3.5 qt Container, 6.56" D x 7.63" H	02	12 ea	7.60/1.11
0600 Δ	6 qt Container, 7.63" D x 8.13" H	02	12 ea	9.55/2.34
0800 Δ	8 qt Container, 7.625" D x 10.75" H	02	12 ea	12.55/3.42
1200 Δ	12 qt Container, 12.25" D x 8.75" H	02	6 ea	8.70/2.24
1800 Δ	18 qt Container, 12.38" D x 13" H	02	6 ea	10.55/3.07
2200 Δ	22 qt Container, 12.25" D x 15.44" H	02	6 ea	13.09/4.20
Bains Marie Polyethylene Container Lids				
0203 Δ	2 – 3.5 qt Lid, 6.69" D	02	12 ea	1.31/0.12
0603 Δ	6 – 8 qt Lid, 8.63" D	02	12 ea	1.90/0.21
1202 Δ	12 – 18 – 22 qt Lid, 12.38" D	02	6 ea	3.12/0.45

NSF Listed products are designated with a Δ and may be prefixed with an N



METAL FOOD PANS & LIDS

Food pans are **the back bone of any foodservice operation**. For storing, preparing, and serving, they are a necessity. Only Carlisle offers you **complete versatility with a broad range of food pans** to meet your needs.

DuraPan™ food pans

Double reinforced corners and unique impact resistant edge design help pans hold shape; will not jam together during storage. Tapered pans fit standard food pan templates and will stack or nest with most other leading brands. Versatile 18-8 stainless pans go from freezer to oven to serving line; ideal for cook-chill operations.

DuraPan Covers

- Made of heavy gauge 18-8 stainless steel
- Available in solid or slotted styles
- Recessed handles offer a secure grip
- Notched lids allow easy access for serving spoons



Steam Table Application

DuraPan's impact resistant edge maintains shape better and lays flat, providing a tight seal for better temperature retention in steam tables



Coldmaster® Application

Use DuraPans with Coldmaster Coldpans (shown on pages 98-99) to keep foods cold without ice or electricity

Full Shoulders
Prevent jamming during storage and provide added strength for longer life

Spoonable Bottoms
Add structural rigidity; allows easy access to food and makes clean up easier



DuraPans Covers, Recessed Handles
Large, recessed handles offer a secure grip. Notched lids allow easy access with serving spoons

Double Reinforced Corners
With unique impact resistant edge design holds shape even under the toughest conditions



Available in heavy gauge or light gauge, Carlisle offers a wide range of accessories including solid and slotted covers, drain shelves, divided pans, and adapter bars.

Prod No	Description	Pack	Cs Wt/Cube
Heavy Gauge			
Full-Size – 20.75" x 12.75"			
608002 Δ	Pan – 2.5" (10.4 qt)	6 ea	20.00/1.09
608004 Δ	Pan – 4" (16.6 qt)	6 ea	26.00/1.76
608006 Δ	Pan – 6" (24.9 qt)	6 ea	26.00/1.56
Two-Thirds Size – 13.88" x 12.75"			
608236 Δ	Pan – 6" (16.2 qt)	6 ea	17.20/1.48
One-Half Size – 12.75" x 10.38"			
608122 Δ	Pan – 2.5" (0.9 qt)	6 ea	10.50/0.48
608124 Δ	Pan – 4" (1.4 qt)	6 ea	13.00/0.81
608126 Δ	Pan – 6" (2.1 qt)	6 ea	16.00/1.03
One-Third Size – 12.75" x 6.88"			
608132 Δ	Pan – 2.5" (3.4 qt)	6 ea	7.75/0.44
608134 Δ	Pan – 4" (5.4 qt)	6 ea	18.00/1.01
608136 Δ	Pan – 6" (8.1 qt)	6 ea	22.00/1.16
One-Quarter Size – 10.38" x 6.38"			
608142 Δ	Pan – 2.5" (2.6 qt)	6 ea	12.00/0.42
608144 Δ	Pan – 4" (4.2 qt)	6 ea	16.00/0.70
608146 Δ	Pan – 6" (6.2 qt)	6 ea	20.00/0.86
One-Sixth Size – 6.88" x 6.25"			
608162 Δ	Pan – 2.5" (1.6 qt)	6 ea	10.00/0.33
608164 Δ	Pan – 4" (2.6 qt)	6 ea	11.00/0.40
608166 Δ	Pan – 6" (3.9 qt)	6 ea	12.00/0.55
One-Ninth Size – 6.88" x 4.25"			
608192 Δ	Pan – 2.5" (1.0 qt)	6 ea	2.83/0.22
608194 Δ	Pan – 4" (1.7 qt)	6 ea	3.33/0.28

Prod No	Description	Pack	Cs Wt/Cube
Light Gauge			
Full-Size – 20.75" x 12.75"			
607001 Δ	Pan – 1" (4.2 qt)	6 ea	15.00/0.89
607002 Δ	Pan – 2.5" (10.4 qt)	6 ea	15.00/1.03
607004 Δ	Pan – 4" (16.6 qt)	6 ea	20.00/1.39
607006 Δ	Pan – 6" (24.9 qt)	6 ea	19.40/2.12
607002P Δ	Perforated Pan – 2.5"	6 ea	15.00/0.98
607004P Δ	Perforated Pan – 4"	6 ea	20.00/1.39
607006P Δ	Perforated Pan – 6"	6 ea	23.00/1.56
607000C Δ	Solid Cover	6 ea	11.60/0.86
607000CS	Slotted Cover	6 ea	13.70/0.90
607000H	Hinged Flat Cover with Handles	6 ea	21.00/1.38
Two-Thirds Size – 13.88" x 12.75"			
607232 Δ	Pan – 2.5" (6.8 qt)	6 ea	25.00/1.08
607236 Δ	Pan – 6" (16.2 qt)	6 ea	17.00/1.55
607230C Δ	Solid Cover	6 ea	17.00/1.02
One-Half Size – 12.75" x 10.38"			
607122 Δ	Pan – 2.5" (0.9 qt)	6 ea	8.40/0.46
607124 Δ	Pan – 4" (1.4 qt)	6 ea	10.00/0.81
607126 Δ	Pan – 6" (2.1 qt)	6 ea	11.80/1.05
607122P Δ	Perforated Pan – 2.5"	6 ea	8.25/0.49
607124P Δ	Perforated Pan – 4"	6 ea	10.00/0.81
607120C Δ	Solid Cover	6 ea	7.50/0.44
607120CS	Slotted Cover	6 ea	6.20/0.41
One-Half Long Size – 20.5" x 6.38"			
60700HL2 Δ	Pan – 2.5" (5.2 qt)	6 ea	21.80/0.90
60700HL4 Δ	Pan – 4" (8.3 qt)	6 ea	12.80/0.95
60700HL6 Δ	Pan – 6" (12.5 qt)	6 ea	13.80/1.14
60700HLC Δ	Solid Cover	6 ea	21.80/0.74
One-Third Size – 12.75" x 6.88"			
607132 Δ	Pan – 2.5" (3.4 qt)	6 ea	5.50/0.30
607134 Δ	Pan – 4" (5.4 qt)	6 ea	7.00/0.53
607136 Δ	Pan – 6" (8.1 qt)	6 ea	20.00/0.98
607130C Δ	Solid Cover	6 ea	4.20/0.28
607130CS	Slotted Cover	6 ea	4.00/0.21
One-Quarter Size – 10.38" x 6.38"			
607142 Δ	Pan – 2.5" (2.6 qt)	6 ea	9.00/0.51
607144 Δ	Pan – 4" (4.2 qt)	6 ea	12.00/0.79
607146 Δ	Pan – 6" (6.2 qt)	6 ea	16.60/0.95
607140C Δ	Solid Cover	6 ea	4.25/0.20
607140CS	Slotted Cover	6 ea	8.00/0.39
One-Sixth Size – 6.88" x 6.25"			
607162 Δ	Pan – 2.5" (1.6 qt)	6 ea	8.00/0.33
607164 Δ	Pan – 4" (2.6 qt)	6 ea	10.00/0.40
607166 Δ	Pan – 6" (3.9 qt)	6 ea	14.00/0.52
607160C Δ	Solid Cover	6 ea	5.20/0.30
607160CS	Slotted Cover	6 ea	5.00/0.30
One-Ninth Size – 6.88" x 4.25"			
607192 Δ	Pan – 2.5" (1.0 qt)	6 ea	13.00/0.22
607194 Δ	Pan – 4" (1.7 qt)	6 ea	18.00/0.28
607190C Δ	Solid Cover	6 ea	5.00/0.20
607190CS	Slotted Cover	6 ea	5.00/0.20

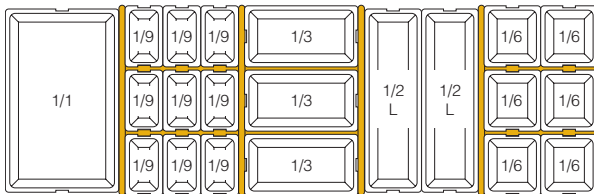
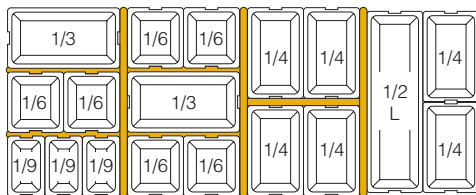

NSF Listed products are designated with a Δ and may be prefixed with an N



METAL FOOD PANS & ACCESSORIES

Divided DuraPans

- Divided pan is perfect for serving complimentary foods
- Single pan fits in full size pan opening; eliminates the need for adapter bars



Divided Pan with PC140N Cateraide™ Top Loader

602202

602203



Drain Grates

- Chrome-plated, heavy-duty gratings with durable welded construction holds food above pan
- Use for cooling or draining foods
- Fits full size pans

Stainless Steel Bains Maries

- Heavy gauge 18-8 stainless steel ideal for serving, storing, and preparing foods, sauces, and dressings
- Easy to clean, satin finish and smooth rounded edges
- Optional covers have recessed handles to allow stacking of covered containers



607912

607904C

607901

607902

607908

Adapter Bars

- Use adapter bars with DuraPans in steam table applications, Cateraides, or other standard transport containers
- Two sizes available to work with full or fractional size pans

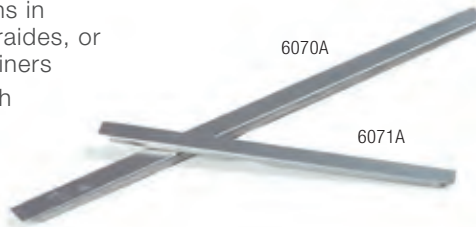

6070A

6071A



Prod No	Description	Color	Pack	Cs Wt/Cube
Divided DuraPans				
607002D ▲	Full-Size Divided Pan 2.5" Deep	—	6 ea	15.00/0.98
Drain Grates				
602202	Drain Grate - Fits Full-Size Food Pan	—	6 ea	7.00/1.29
602203	Drain Grate - Fits Half-Size Food Pan	—	6 ea	5.00/0.19
Bains Maries				
607901	1.25 qt Bains Marie	—	6 ea	7.00/0.27
607902	2 qt Bains Marie	—	6 ea	8.00/0.44
607904	4.25 qt Bains Marie	—	6 ea	7.80/0.81
607908	8.25 qt Bains Marie	—	6 ea	13.60/1.37
607912	12 qt Bains Marie	—	6 ea	19.00/2.19
607902C	2 qt Cover	—	6 ea	2.00/0.12
607904C	4.25 qt Cover	—	6 ea	2.20/0.17
607908C	8.25 qt Cover	—	6 ea	4.00/0.26
607912C	12 qt Cover	—	6 ea	6.00/0.30
Adapter Bars				
6070A ▲	20.5" Adapter Bar	—	12 ea	6.00/0.24
6071A ▲	12.75" Adapter Bar	—	12 ea	3.00/0.09

NSF Listed products are designated with a ▲ and may be prefixed with an N
 Note: Capacities are based on liquid measurements to rim, i.e. flush fill



Insets

- Use in round steam tables or soup warmers and stations
- Offer heavy gauge, 18-8 stainless steel satin finish and smooth rounded edges
- Optional covers help maintain temperatures, sold separately
- Hinged covers clip to inset, allowing one-hand access
- Bakelite knob on hinged cover stays cool to the touch



Ingredient Bins

- Portable, convenient storage bins for large quantities of sugar, flour, etc.
- Lids slide open for easy access
- Heavy-duty, non-marking casters
- Replacement Parts for BIN27, BIN36, & BIN44 shown in chart below



Floor Rack System

- Interlocking modular system provides a raised surface in dry and cooling storage areas
- Perfect for areas where moisture collects on the floor
- Open design allows for air circulation
- 12" square units lock together, holds up to 3,000 pounds per square foot
- Made of FDA approved high density polyethylene, withstands temperatures from -40°F to 180°F
- NSF Listed; dishwasher safe or clean with hose



Note: Capacities are based on liquid measurements to rim, i.e. flush fill



Prod No	Description	Color	Pack	Cs Wt/Cube
Insets				
607704	4 qt Inset - Fits 6.5" Opening	—	6 ea	8.00/0.63
607707	7 qt Inset - Fits 8.5" Opening	—	6 ea	11.00/0.99
607711	11 qt Inset - Fits 10.5" Opening	—	6 ea	10.00/1.14
607704CS	4 qt Slotted Cover	—	6 ea	2.60/0.20
607707CS	7 qt Slotted Cover	—	6 ea	4.00/0.33
607711CS	11 qt Slotted Cover	—	6 ea	7.00/0.35
607707H	7 qt Hinged Cover	—	6 ea	6.40/0.59
607711H	11 qt Hinged Cover	—	6 ea	9.00/0.78
Ingredient Bins				
BIN27	27 gal Capacity Bin, 28.5"L x 12.69"W x 27.88"H	02	1 ea	27.80/6.61
BIN36	36 gal Capacity Bin, 29.5"L x 15.38"W x 28.25"H	02	1 ea	28.40/8.00
BIN44	44 gal Capacity Bin, 29.5"L x 18.13"W x 29"H	02	1 ea	32.30/9.56
BIN27L	Replacement lid for BIN27	02	1 ea	4.50/0.64
BIN36L	Replacement lid for BIN36	02	1 ea	5.65/0.64
BIN44L	Replacement lid for BIN44	02	1 ea	5.85/0.64
Floor Rack				
2710 ▲	12" x 12" x 1.5" Floor Rack	23	12 ea	19.15/2.09

DANGER

CARLISLE
FOODSERVICE PRODUCTS



EFFICIENT
DURABLE
INNOVATIVE
SMART
**WARE-
WASHING
PRODUCTS**

Carlisle offers every rack, basket, and accessory you need for efficient warewashing operations. OptiClean™ is the industry standard for enabling clean, spotless ware. Our full line of color-coded rack extenders and Plaque-a-Rack are the ideal solution for sorting and managing your ware.





OPTICLEAN®

Build Your Perfect System

- OptiClean's basic three-component system of base racks and open and divided extenders allow you to construct the exact configuration you need
- Sure-Lock Extender design makes alterations quick and easy
- The user-friendly product numbering system refers to the exact type of rack you're ordering, without any complicated formulas
- Each number consists of an "R" followed by a descriptor – "G" for Glass, "W" for NeWave, "P" for Peg, etc
- Glass and cup racks are further defined by their number of compartments, ie: RG16 for a 16-compartment glass rack base
- To add extenders to your order, just add a dash and the number of extenders you need to the end of the basic product number, such as "RG16-3" for a 16-compartment glass rack with three extenders (note: each extender adds approximately 1.5" of additional height to the inside compartment of the rack)
- Use the unique Plaque-A-Rack System shown on pages 234-235 for the ultimate in easy-to-use rack identification

Glass Rack Compatibility Chart

- Carlisle's Glass Rack Compatibility Chart is available at www.carlislefsp.com/findrack
- Once there you can find recommendations for glass racks designed to be used with Anchor Hocking, Cardinal, Libby, and Oneida Glassware as well as Carlisle Tumblers
- Glass Rack recommendations are based on both the measurements provided by each glassware manufacturer and the minimum clearance required for optimum cleaning performance
- Because actual glasses vary in size, you may prefer to use our glass rack sizing guide shown on facing page

All OptiClean Racks have an outside measurement of 19.75" x 19.75"

Three component system

Our combination of base rack and alternating open and divided extenders offers the greatest protection without sacrificing performance

Quick Draining

No flat surfaces to trap water or loose food particles inside the rack – ensures proper drainage

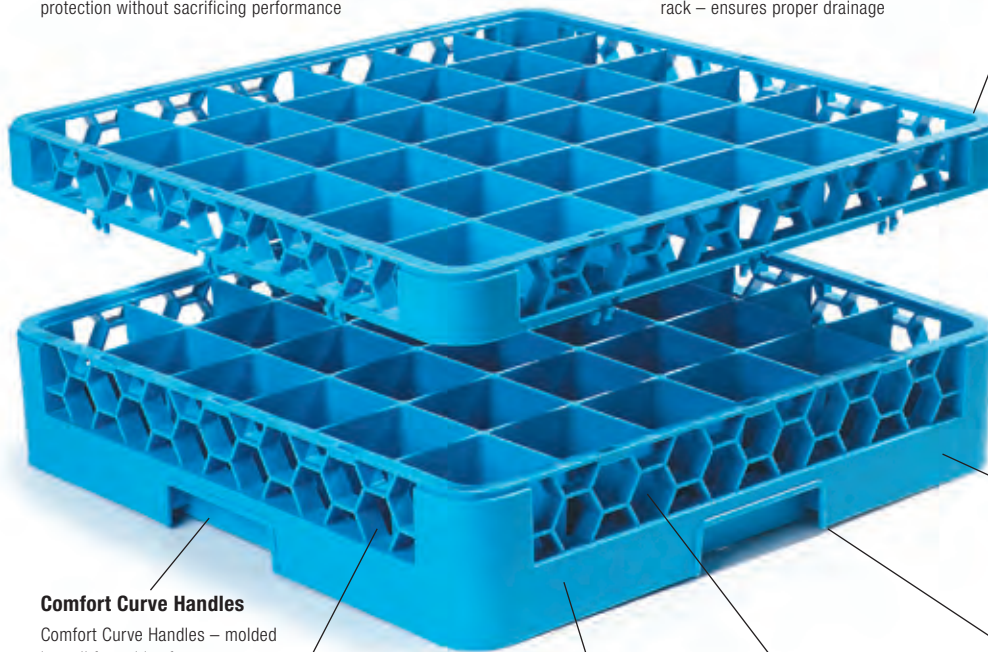

Positive stacking

Positive stacking from either direction – stacks with all major competitors

Sure-Lock Extenders

Sure-Lock™ Extenders unique snap-on/snap-off attachments allow for fast, simple assembly/disassembly from the outside of the rack without loose screws, other fasteners, or even tools

Double wall construction

Double wall construction for maximum strength, protects contents from moving machine parts

Comfort Curve Handles

Comfort Curve Handles – molded into all four sides for easy handling, won't pinch fingers

Open profile design

Open profile facilitates superior washing, complete rinsing, and fast drying

Four-way tracking

Sturdy bottom with four-way tracking for easy dish machine loading without the need to rotate racks

Honeycomb design

Unique "honeycomb" design distributes load more effectively – like a brick wall, while smooth rounded edges on the large openings provide multiple hand-holds and a sure grip on racks from any angle

Textured Finish

Non-slip textured finish on outside walls reduces scratches to keep racks looking new longer, improves durability, and provides a secure grip

Glass Rack Sizing Guide

Instructions:

1. Place glass upside down on top of the middle circle of the sizing guide; center of the glass (or the stem on stemware) should be over the center of the guide.
2. Look down on the base of the glass.
3. Note the smallest circle on the guide where the largest outside diameter of your glass lines up completely within the circle without touching it – this is the number of compartments your rack needs to have.
4. Place lip of glass against the base line of the vertical guide on the right-hand side of the page with the base/foot of the glass pointing straight up towards the top of the page.
5. While holding the glass against the vertical guide, note where the base/foot of the glass lines up on the vertical guide – the next line above the base/foot on the guide indicates the number of extenders your rack will require.
6. Carlisle's unique OptiClean Warewashing rack system allows you to build the perfect rack for any application. Glasses with a maximum height exceeding 10.5" will need more than five extenders. Custom racks requiring more than five extenders are available for order by contacting a Carlisle FoodService Products customer service representative. Each extender adds approximately 1.5" of additional height to the inside compartment of the rack.
 - For glasses with a maximum diameter exceeding 6", Carlisle FoodService Products recommends using the RTP peg rack. The RTP peg rack can be custom ordered to accommodate any glass height.
 - Please contact a Carlisle FoodService Products customer service representative to place your order, or for more information about building the ideal rack for your needs.

Sizing Guide

Note: Guide below represents diameter/size of recommended glass to fit corresponding compartment.

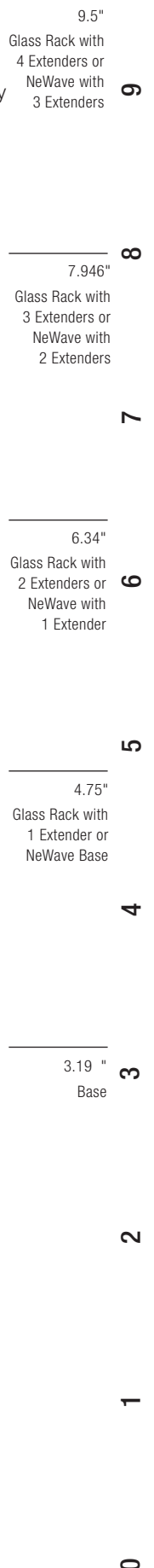
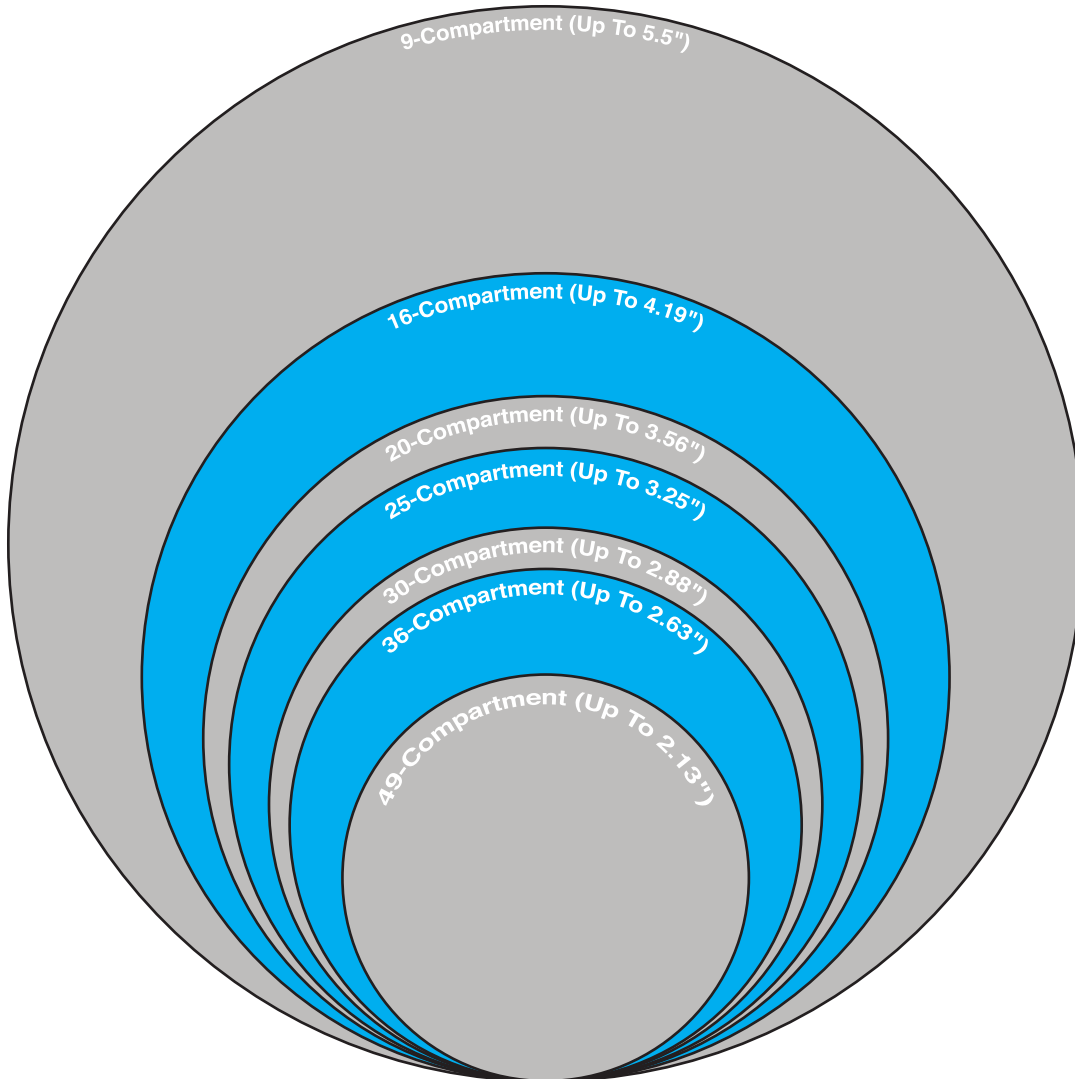



OPTICLEAN®

Color-Coded Glass Racks

- OptiClean Glass Racks with Color-Coded Extenders make it easy to identify glass rack size or match specific glassware with a specific rack simply by color
- Carlisle's OptiClean system includes a full range of glass racks designed to meet your needs
- Full dividers in the base offer complete protection for delicate rims
- NSF Listed



Available Colors & Combinations

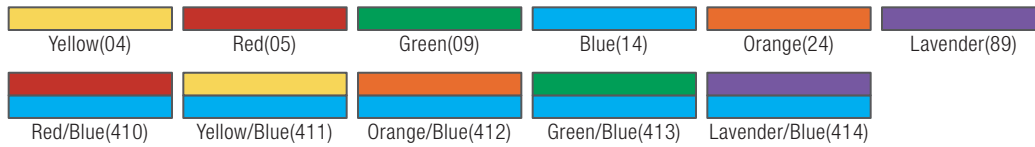

New Color-Coded Options

Organize Your Operation

If your operation has multiple drinkware styles that need to be washed, stored, and easily identified, Carlisle has a solution to make work easier. Our OptiClean extenders are now available in six color choices. Use this option to color-code your glass racks and keep each piece of drinkware in its proper place. If you have multiple areas of serving within your establishment you can designate specific colors so that your fine dining stemware stays separate from the poolside drinkware.





OptiClean NeWave Color-Coded Glass Racks

- Same features as our OptiClean Glass Racks with an added practical interior design that holds 20% more glasses than comparable square racks
- NeWave Glass Racks are a green choice as they help to lower your chemical usage and labor costs
- Rounded design holds glasses securely in place, resulting in less movement and breakage
- NeWave offers two compartment sizes designed to fit the most popular sizes of glassware and tumblers
- NSF Listed



NeWave 20-Compartment

- Use for glasses & tumblers

NeWave 30-Compartment

- Use for glasses & tumblers



RW20-1C



RW30-2

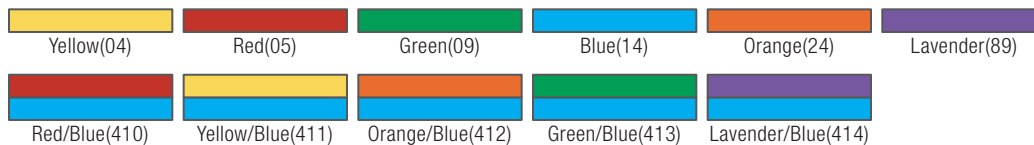

Prod No	Description	Glass Dia*	Glass Height	Color	Pack	Cs Wt/Cube
20-Compartment NeWave Glass Rack - Compartment Size 3.81" Dia						
RW20 Δ	20-Compartment with Integrated Extender	3.56"	4.75"	14	4 ea	28.90/1.35
RW20-1 Δ	20-Compartment with 2 Extenders	3.56"	6.34"	14	3 ea	28.70/5.46
RW20-2 Δ	20-Compartment with 3 Extenders	3.56"	7.94"	14	2 ea	22.00/4.48
RW20-3 Δ	20-Compartment with 4 Extenders	3.56"	9.5"	14	2 ea	25.60/5.30
REW20S	20-Compartment Extender	3.56"	1.5"	14	6 ea	13.90/2.77
20-Compartment Color-Coded NeWave Glass Rack—Compartment Size 3.81" Dia						
REW20SC	20-Compartment Divided Extender	3.56"	1.5"	04, 05, 09, 24, 89	6 ea	13.90/2.77
RW20-C Δ	20-Compartment with Integrated Extender	3.56"	4.75"	410, 411, 412, 413, 414	4 ea	28.90/1.35
RW20-1C Δ	20-Compartment with 2 Extenders	3.56"	6.34"	410, 411, 412, 413, 414	3 ea	28.70/5.46
RW20-2C Δ	20-Compartment with 3 Extenders	3.56"	7.94"	410, 411, 412, 413, 414	2 ea	22.00/4.48
RW20-3C Δ	20-Compartment with 4 Extenders	3.56"	9.5"	410, 411, 412, 413, 414	2 ea	25.60/5.30
RW20-4C Δ	20-Compartment with 5 Extenders	3.56"	11.1"	410, 411, 412, 413, 414	1 ea	27.92/6.12
30-Compartment NeWave Glass Rack - Compartment Size 3.13" Dia						
RW30 Δ	30-Compartment with Integrated Extender	2.88"	4.75"	14	4 ea	31.80/1.35
RW30-1 Δ	30-Compartment with 2 Extenders	2.88"	6.34"	14	3 ea	31.70/5.46
RW30-2 Δ	30-Compartment with 3 Extenders	2.88"	7.94"	14	2 ea	24.00/4.48
RW30-3 Δ	30-Compartment with 4 Extenders	2.88"	9.5"	14	2 ea	26.70/5.30
REW30S	30-Compartment Extender	2.88"	1.5"	14	6 ea	15.60/2.77
30-Compartment Color-Coded NeWave Glass Rack—Compartment Size 3.13" Dia						
REW30SC	30-Compartment Divided Extender	3.56"	1.5"	04, 05, 09, 24, 89	6 ea	13.90/2.77
RW30-C Δ	30-Compartment with Integrated Extender	2.88"	4.75"	410, 411, 412, 413, 414	4 ea	31.80/1.35
RW30-1C Δ	30-Compartment with 2 Extenders	2.88"	6.34"	410, 411, 412, 413, 414	3 ea	31.70/5.46
RW30-2C Δ	30-Compartment with 3 Extenders	2.88"	7.94"	410, 411, 412, 413, 414	2 ea	24.00/4.48
RW30-3C Δ	30-Compartment with 4 Extenders	2.88"	9.5"	410, 411, 412, 413, 414	2 ea	26.70/5.30
RW30-4C Δ	30-Compartment with 5 Extenders	2.88"	11.1"	410, 411, 412, 413, 414	1 ea	29.30/6.12

NSF Listed products are designated with a Δ and may be prefixed with an N

*Dimensions shown are for the recommended maximum glass size for the compartment



OPTICLEAN®

9-Compartment

- Use with large brandy snifters, grande margaritas, carafes, and other items with a wide diameter



RG9-1

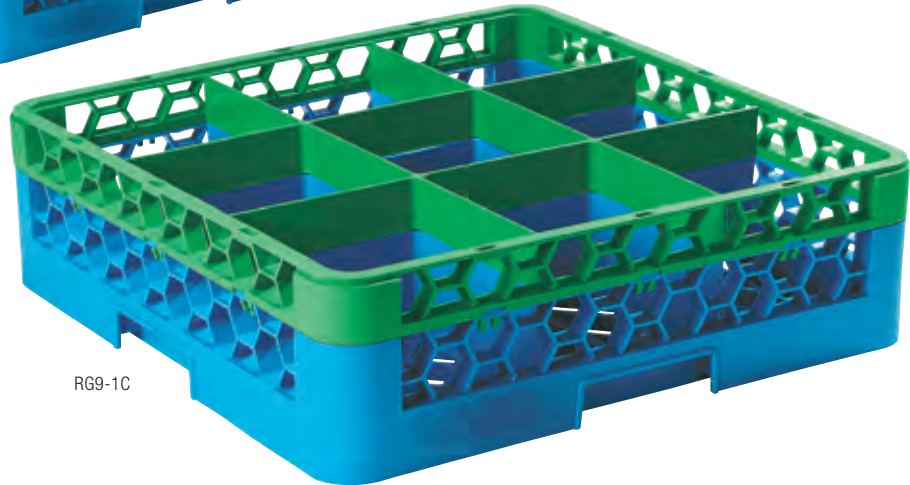

RG9-1C

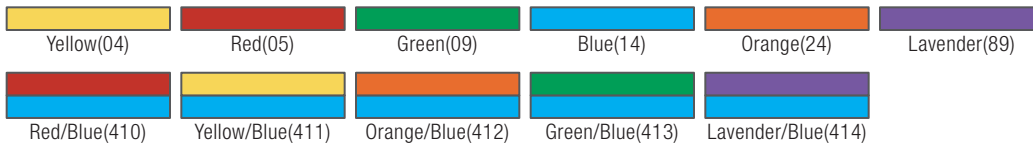

Prod No	Description	Glass Dia**	Glass Height	Color	Pack	Cs Wt/Cube
9-Compartment Glass Rack—Compartment Size 5.81" Square						
RG9 Δ	9-Compartment	5.56"	3.19"	14	6 ea	28.50/6.21
RG9-1 Δ	9-Compartment with 1 Extender	5.56"	4.75"	14	4 ea	23.65/5.80
RG9-2 Δ	9-Compartment with 2 Extenders	5.56"	6.34"	14	3 ea	21.35/5.55
RG9-3 Δ	9-Compartment with 3 Extenders	5.56"	7.94"	14	2 ea	18.00/4.54
RG9-4 Δ	9-Compartment with 4 Extenders	5.56"	9.5"	14	2 ea	20.75/5.30
RG9-5 Δ	9-Compartment with 5 Extenders	5.56"	11.1"	14	2 ea	28.10/6.12
RE9	9-Compartment Divided Extender	5.56"	9.5"	14	6 ea	9.60/2.77
RE*	Open Extender	—	1.5"	14	6 ea	7.75/2.77
9-Compartment Color-Coded Glass Rack—Compartment Size 5.81" Square						
RG9-1C Δ	9-Compartment with 1 Extender	5.56"	4.75"	410, 411, 412, 413, 414	4 ea	23.65/5.80
RG9-2C Δ	9-Compartment with 2 Extenders	5.56"	6.34"	410, 411, 412, 413, 414	3 ea	21.35/5.55
RG9-3C Δ	9-Compartment with 3 Extenders	5.56"	7.94"	410, 411, 412, 413, 414	2 ea	18.00/4.54
RG9-4C Δ	9-Compartment with 4 Extenders	5.56"	9.5"	410, 411, 412, 413, 414	2 ea	20.75/5.30
RG9-5C Δ	9-Compartment with 5 Extenders	5.56"	11.1"	410, 411, 412, 413, 414	2 ea	28.10/6.12
RE9C	9-Compartment Divided Extender	5.56"	1.5"	04, 05, 09, 24, 89	6 ea	9.60/2.77
RE*	Open Extender	—	1.5"	14	6 ea	7.75/2.77

NSF Listed products are designated with a Δ and may be prefixed with an N

* Note: The RE Open Extender can be used with any OptiClean Glass or Dish Rack

**Dimensions shown are for the recommended maximum glass size for the compartment



16-Compartment

- Perfect for large cocktail glasses and delicate wine stems with oversize bowls



RG16-1



RG16-2C

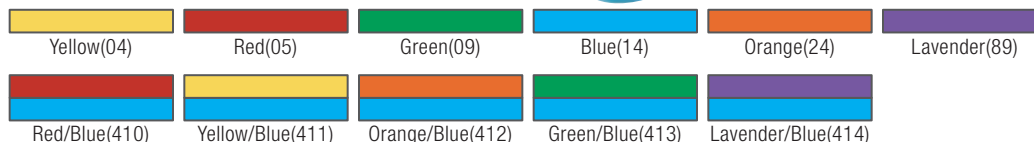

Prod No	Description	Glass Dia**	Glass Height	Color	Pack	Cs Wt/Cube
---------	-------------	-------------	--------------	-------	------	------------

16-Compartment OptiClean Glass Rack – Compartment Size 4.44" Square

RG16 Δ	16-Compartment	4.19"	3.19"	14	6 ea	29.65/5.99
RG16-1 Δ	16-Compartment with 1 Extender	4.19"	4.75"	14	4 ea	25.60/5.42
RG16-2 Δ	16-Compartment with 2 Extenders	4.19"	6.34"	14	3 ea	23.00/5.46
RG16-3 Δ	16-Compartment with 3 Extenders	4.19"	7.94"	14	2 ea	19.30/4.48
RG16-4 Δ	16-Compartment with 4 Extenders	4.19"	9.5"	14	2 ea	20.75/5.30
RG16-5 Δ	16-Compartment with 5 Extenders	4.19"	11.1"	14	2 ea	28.10/6.12
RE16	16-Compt Divided Extender	4.19"	1.5"	14	6 ea	10.75/2.77
RE*	Open Extender	—	1.5"	14	6 ea	7.75/2.77

16-Compartment OptiClean Color-Coded Glass Rack – Compartment Size 4.44" Square

RG16-1C Δ	16-Compartment with 1 Extender	4.19"	4.75"	410, 411, 412, 413, 414	4 ea	25.60/5.42
RG16-2C Δ	16-Compartment with 2 Extenders	4.19"	6.34"	410, 411, 412, 413, 414	3 ea	23.00/5.46
RG16-3C Δ	16-Compartment with 3 Extenders	4.19"	7.94"	410, 411, 412, 413, 414	2 ea	19.30/4.48
RG16-4C Δ	16-Compartment with 4 Extenders	4.19"	9.5"	410, 411, 412, 413, 414	2 ea	20.75/5.30
RG16-5C Δ	16-Compartment with 5 Extenders	4.19"	11.1"	410, 411, 412, 413, 414	2 ea	28.10/6.12
RE16C	16-Compartment Divided Extender	4.19"	1.5"	04, 05, 09, 24, 89	6 ea	10.75/2.77
RE*	Open Extender	—	1.5"	14	6 ea	7.75/2.77

NSF Listed products are designated with a Δ and may be prefixed with an N

* Note: The RE Open Extender can be used with any OptiClean Glass or Dish Rack

**Dimensions shown are for the recommended maximum glass size for the compartment



OPTICLEAN®

25-Compartment

- Use for large diameter beverage glasses, red wine stems, goblets, and most rocks glasses



RG25-1



RG25-1C

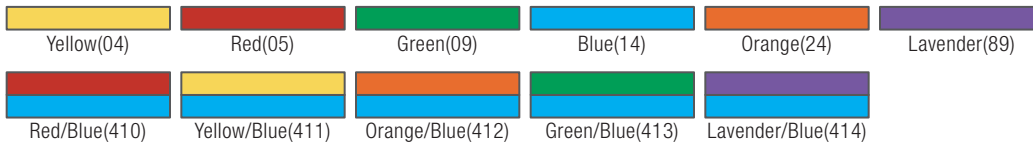

Prod No	Description	Glass Dia**	Glass Height	Color	Pack	Cs Wt/Cube
25-Compartment OptiClean Glass Rack—Compartment Size 3.5" Square						
RG25 Δ	25-Compartment	3.25"	3.19"	14	6 ea	30.30/5.99
RG25-1 Δ	25-Compartment with 1 Extender	3.25"	4.75"	14	4 ea	29.30/5.58
RG25-2 Δ	25-Compartment with 2 Extenders	3.25"	6.34"	14	3 ea	25.20/5.42
RG25-3 Δ	25-Compartment with 3 Extenders	3.25"	7.94"	14	2 ea	21.10/4.51
RG25-4 Δ	25-Compartment with 4 Extenders	3.25"	9.5"	14	2 ea	23.00/5.30
RG25-5 Δ	25-Compartment with 5 Extenders	3.25"	11.1"	14	2 ea	28.10/6.12
RE25	25-Compartment Divided Extender	3.25"	1.5"	14	6 ea	12.15/2.77
RE*	Open Extender	—	1.5"	14	6 ea	7.75/2.77
25-Compartment OptiClean Color-Coded Glass Rack—Compartment Size 3.5" Square						
RG25-1C Δ	25-Compartment with 1 Extender	3.25"	4.75"	410, 411, 412, 413, 414	4 ea	29.30/5.58
RG25-2C Δ	25-Compartment with 2 Extenders	3.25"	6.34"	410, 411, 412, 413, 414	3 ea	25.20/5.42
RG25-3C Δ	25-Compartment with 3 Extenders	3.25"	7.94"	410, 411, 412, 413, 414	2 ea	21.10/4.51
RG25-4C Δ	25-Compartment with 4 Extenders	3.25"	9.5"	410, 411, 412, 413, 414	2 ea	23.00/5.30
RG25-5C Δ	25-Compartment with 5 Extenders	3.25"	11.1"	410, 411, 412, 413, 414	2 ea	28.10/6.12
RE25C	25-Compartment Divided Extender	3.25"	1.5"	04, 05, 09, 24, 89	6 ea	12.15/2.77
RE*	Open Extender	—	1.5"	14	6 ea	7.75/2.77

NSF Listed products are designated with a Δ and may be prefixed with an N

* Note: The RE Open Extender can be used with any OptiClean Glass or Dish Rack

**Dimensions shown are for the recommended maximum glass size for the compartment



36-Compartment

- Use with tumblers, white wine glasses, and other narrow bowl stems

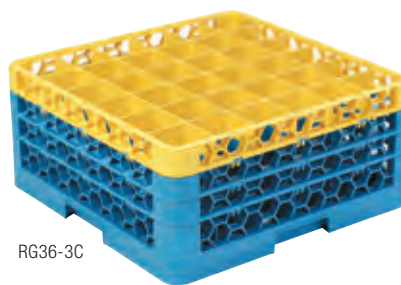

Prod No	Description	Glass Dia**	Glass Height	Color	Pack	Cs Wt/Cube
36-Compartment OptiClean Glass Rack—Compartment Size 2.94" Square						
RG36 Δ	36-Compartment	2.69"	3.19"	14	6 ea	35.55/5.99
RG36-1 Δ	36-Compartment with 1 Extender	2.69"	4.75"	14	4 ea	31.80/5.58
RG36-2 Δ	36-Compartment with 2 Extenders	2.69"	6.34"	14	3 ea	27.10/5.46
RG36-3 Δ	36-Compartment with 3 Extenders	2.69"	7.94"	14	2 ea	22.70/4.45
RG36-4 Δ	36-Compartment with 4 Extenders	2.69"	9.5"	14	2 ea	26.00/5.30
RG36-5 Δ	36-Compartment with 5 Extenders	2.69"	11.1"	14	2 ea	28.10/6.12
RE36	36-Compartment Divided Extender	2.69"	1.5"	14	6 ea	13.35/2.77
RE*	Open Extender/Hgt: 1.5"	—	1.5"	14	6 ea	7.75/2.77
36-Compartment OptiClean Color-Coded Glass Rack—Compartment Size 2.94" Square						
RG36-1C Δ	36-Compartment with 1 Extender	2.69"	4.75"	410, 411, 412, 413, 414	4 ea	31.80/5.58
RG36-2C Δ	36-Compartment with 2 Extenders	2.69"	6.34"	410, 411, 412, 413, 414	3 ea	27.10/5.46
RG36-3C Δ	36-Compartment with 3 Extenders	2.69"	7.94"	410, 411, 412, 413, 414	2 ea	22.70/4.45
RG36-4C Δ	36-Compartment with 4 Extenders	2.69"	9.5"	410, 411, 412, 413, 414	2 ea	26.00/5.30
RG36-5C Δ	36-Compartment with 5 Extenders	2.69"	11.1"	410, 411, 412, 413, 414	2 ea	28.10/6.12
RE36C	36-Compartment Divided Extender	2.69"	1.5"	04, 05, 09, 24, 89	6 ea	13.35/2.77

49-Compartment

- Ideal for juice glasses, narrow champagne flutes, cordials, and shot glasses

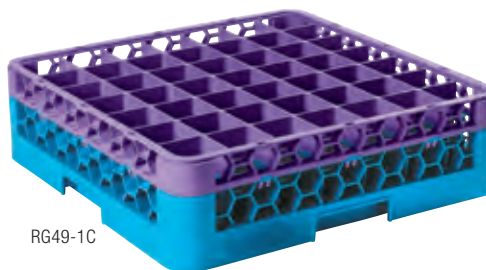

Prod No	Description	Glass Dia**	Glass Height	Color	Pack	Cs Wt/Cube
49-Compartment Glass Rack—Compartment Size 2.38" Square						
RG49 Δ	49-Compartment	2.13"	3.19"	14	6 ea	37.85/6.21
RG49-1 Δ	49-Compartment with 1 Extender	2.13"	4.75"	14	4 ea	31.30/5.80
RG49-2 Δ	49-Compartment with 2 Extenders	2.13"	6.34"	14	3 ea	31.50/5.55
RG49-3 Δ	49-Compartment with 3 Extenders	2.13"	7.94"	14	2 ea	23.20/4.45
RG49-4 Δ	49-Compartment with 4 Extenders	2.13"	9.5"	14	2 ea	20.75/5.30
RE49	49-Compartment Divided Extenders	2.13"	1.5"	14	6 ea	14.90/2.77
RE*	Open Extender	—	1.5"	14	6 ea	7.75/2.77
49-Compartment Color-Coded Glass Rack—Compartment Size 2.38" Square						
RG49-1C Δ	49-Compartment with 1 Extender	2.13"	4.75"	410, 411, 412, 413, 414	4 ea	31.30/5.80
RG49-2C Δ	49-Compartment with 2 Extenders	2.13"	6.34"	410, 411, 412, 413, 414	3 ea	31.50/5.55
RG49-3C Δ	49-Compartment with 3 Extenders	2.13"	7.94"	410, 411, 412, 413, 414	2 ea	23.20/4.45
RG49-4C Δ	49-Compartment with 4 Extenders	2.13"	9.5"	410, 411, 412, 413, 414	2 ea	20.75/5.30
RG49-5C Δ	49-Compartment with 5 Extenders	2.13"	11.1"	410, 411, 412, 413, 414	2 ea	20.75/5.30
RE49C	49-Compartment Divided Extender	2.13"	1.5"	04, 05, 09, 24, 89	6 ea	14.90/2.77

NSF Listed products are designated with a Δ and may be prefixed with an N

* Note: The RE Open Extender can be used with any OptiClean Glass or Dish Rack

**Dimensions shown are for the recommended maximum glass size for the compartment



OPTICLEAN®

Dish Racks

OptiClean Dish Racks offer the safest and most sanitary cleaning choices for everything from the most fragile tableware to heavy-duty kitchen items such as utensils and cutlery. These racks are NSF Listed and offer all the same great features as the rest of Carlisle's wash racks such as sturdy double wall construction and Comfort Curve™ Handles molded into all four sides.



Peg Racks

- Holds plates, trays, and platters at the best angle to take full advantage of today's multiple spray, high-pressure dishwashers
- Plate locks hold dishes firmly in place to protect delicate rims, reduce chipping and breakage
- Use with additional Open Extenders (RE) to create the perfect rack for irregular or oversize drinkware
- NSF Listed

Tall Peg Plate & Tray Rack

- Extra tall 2.94" pegs are ideal for charger plates, pasta bowls, large platters, and trays

Open End Peg Rack

- Tall 2.94" pegs with open ended design hold all types of trays, standard size baking sheets, and other long items

Open/Bowl Rack

- Sturdy open bottom rack is ideal for all large bowls, containers, brushes, cookware, and cutlery

Combination/Flatware Rack

- Bottom grid allows for free flow of water and air
- Keeps flatware in place for thorough washing and drying
- Perfect for ramekins, and other small items
- NSF Listed



RTP

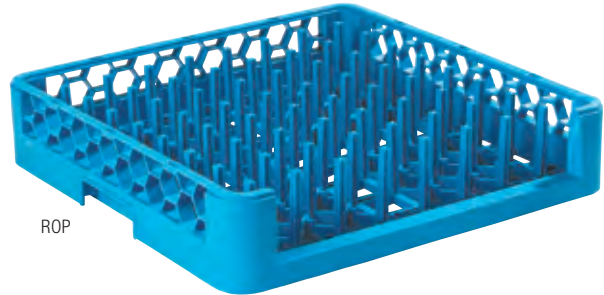

ROP



RB



RF



Blue(14)

Prod No	Description	Color	Pack	Cs Wt/Cube
Peg Racks & Extender				
RP	All-Purpose Plate & Tray Rack	14	6 ea	29.00/5.66
RTP Δ	Tall Peg Plate & Tray Rack	14	6 ea	27.70/5.74
ROP Δ	Open End Peg Rack	14	6 ea	26.75/5.87
RE*	Open Extender	14	6 ea	7.75/2.77
Open/Bowl Rack & Extender				
RB Δ	Open/Bowl Rack	14	6 ea	22.25/6.18
RE*	Open Extender	14	6 ea	7.75/2.77
Combination/Flatware Rack				
RF Δ	Combination/Flatware Rack	14	6 ea	25.15/5.93
RE*	Open Extender	14	6 ea	7.75/2.77

NSF Listed products are designated with a Δ and may be prefixed with an N

* Note: The RE Open Extender can be used with any OptiClean Glass or Dish Rack



Cup Racks

- Tilted design promotes thorough washing of rims and interiors
- Encourages bases to drain more efficiently
- 16-Compartment holds larger diameter cups and mugs in tilted position; compartment size: 4.34" x 4.34"
- 20-Compartment works with most standard size cups; compartment size: 4.34" x 3.41"
- NSF Listed



RC20-1



Bakery Tray & Sheet Pan Rack

- Rack securely holds sheet or bun pans low enough to fit standard height dish machine openings
- Contents are angled to take full advantage of multiple spray arms
- NSF Listed



RSP



Food Pan/Insulated Meal Delivery Tray Rack

- Accommodates all sizes of 2.5" deep food pans and standard steam table inserts
- Racks are angled for thorough cleaning
- Perfect for health care or correctional facilities using insulated meal delivery compartment trays
- NSF Listed



RFP



Plate Cover Rack

- Use with plate covers, dishwasher safe insulated dome covers, or dishwasher safe pellet bases
- Specially designed insert keeps contents separated during washing
- NSF Listed



RPC



Blue(14)

Prod No	Description	Color	Pack	Cs Wt/Cube
Cup Racks				
RC16 Δ	16-Compartment Cup Rack	14	6 ea	32.00/5.99
RC16-1 Δ	16-Compartment Cup Rack with 1 Open Extender	14	4 ea	24.85/5.55
RC20 Δ	20-Compartment Cup Rack	14	6 ea	32.20/5.93
RC20-1 Δ	20-Compartment Cup Rack with 1 Open Extender	14	4 ea	25.60/5.77
Bakery Tray & Sheet Pan Rack				
RSP Δ	Bakery Tray & Sheet Pan Rack	14	3 ea	19.20/3.28
Food Pan/Insulated Meal Delivery Tray Rack				
RFP Δ	Food Pan/Insulated Meal Delivery Tray Rack	14	3 ea	20.50/4.23
Plate Cover Rack				
RPC Δ	Plate Cover Rack	14	3 ea	21.60/3.94

NSF Listed products are designated with a Δ and may be prefixed with an N
 * Note: The RE Open Extender can be used with any OptiClean Glass or Dish Rack



OPTICLEAN® ACCESSORIES

Hold Down Grid

- Use with small, light-weight, or delicate items to prevent them from being displaced by high pressure sprayers
- Snaps down securely and fits all OptiClean Glass & Dish Racks
- NSF Listed



Half Size Stack-All™ Racks

- Compact 10" x 19.75" size will work in any 19.75" dishwasher
- Sturdy single wall construction
- Open design for superior water and air circulation
- Made of high impact polypropylene
- NSF Listed

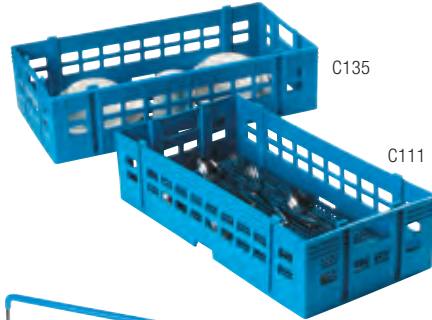

Perma-Sil™ Cylinders & Carriers

Flatware Cylinders

- Meshed bottom and open sides are best for the dispersion of water and air; ideal for washing or storing flatware



Carriers

- Heavy gauge wire construction is chrome plated
- Vinyl-coated insulated handle

Perma-San™ Flatware Washing Baskets

- Open design for easy cleaning of vertically stored flatware
- Use with RF Flatware Rack or RB Open/Bowl Rack as part of a complete flatware sanitizing system
- Tough polypropylene material resists grease and detergents
- C32P1 and C32P2 are NSF Listed



Prod No	Description	Glass Dia	Glass Height	Color	Pack	Cs Wt/Cube
Hold Down Grid						
C93 ▲	Vinyl Coated Wire Grid	—	—	14	6 ea	22.00/1.29
Half Size Stack-All Racks						
C135 ▲	Open Bowl/Cup/Glass Rack	—	4.5"	14	6 ea	15.80/3.97
C111 ▲	Flatware Rack	—	4.5"	14	6 ea	17.20/3.91
Perma-Sil Cylinders & Carriers						
C35P	Poly Cylinder	—	—	02	12 ea	3.30/0.86
CW6C	6-Compartment Portable Carrier	—	—	38	6 ea	23.00/5.25
C32P1 ▲	Flatware Basket without Handles	—	—	14	6 ea	15.60/4.13
C32P2 ▲	Flatware Basket with Handles	—	—	14	6 ea	17.00/4.13

NSF Listed products are designated with a ▲ and may be prefixed with an N



E-Z Glide™ Rack Dollies

Aluminum Dollies

- Hold and transport any 19.75" square stack of glass racks
- Large 4" ball bearing swivel casters with non-marking rubber wheels
- 300 lb weight capacity

Polypropylene Dollies

- C2236/C2236H injection molded dollies squared corners are designed to hold any standard 19.75" racks including older style square racks
- 350 lb weight capacity
- Dollies trap water from wet racks; convenient drain feature makes emptying water easy



Dust Cover

- Heavy-duty vinyl covers keep tableware clean during storage
- Easily converts warewashing racks into storage racks
- Combine with E-Z Glide Dollies and Rack Covers (shown left) for a complete storage system



Rack Cover

- Hard cover protects rack contents during storage



Prod No	Description	Color	Pack	Cs Wt/Cube
E-Z Glide Rack Dollies				
C2220A	Open Aluminum Dolly, No Handle	14	1 ea	13.50/1.92
C2222A	Open Aluminum Dolly with Handle	14	1 ea	18.50/3.37
C2236	Warewashing Rack Dolly, No Handle	03, 14	1 ea	18.50/2.83
C2236H	Warewashing Rack Dolly with Handle	03, 14	1 ea	22.70/4.35
C2237	Handle for C2236 & C2236H		1 ea	5.80/1.22
C2222C	Replacement Caster for C2220A & C2222A		1 ea	2.70/0.21
C2222HD	Handle for C2220A & C2222A		1 ea	7.00/3.37
Rack Cover				
RHC	Rack Cover	02	1 ea	2.75/0.35
Dust Covers				
RDC ▼	36" Long Rack Dust Cover	07	3 ea	4.65/0.57
RDC1 ▼	48" Long Rack Dust Cover	07	3 ea	5.75/0.60

NSF Listed products are designated with a **Δ** and may be prefixed with an N

WARNING: Products identified on this page with the following symbol ▼ contain chemicals, including one or more phthalates, known to the State of California to cause cancer and birth defects and other reproductive harm.



PLAQUE-A-RACK

Carlisle's Plaque-A-Rack System is the proven standard in custom rack labeling. The highly visible plaques fit up to three across on both bases and extenders for complete versatility. Plaques can be easily added, removed, or changed as needed. Sturdy reusable plaques are made from a high-impact plastic and won't come off during the normal wear and tear of daily usage – offering a permanent identification system for the life of your racks.



Plaque example shown above: XRG25-2 with 203, 303, 103

- Plaque-A-Rack provides four ways to customize your Glass Rack System:
 - glassware silhouette
 - glassware style by name
 - location of glassware usage or storage
 - custom color coding options
- Plaques are hot stamped for durability
- Plaques are Carlisle Blue(14), unless otherwise specified
- All plaques are 3" long by 1" high
- Racks can be ordered with up to three possible plaque imprints
- There is a \$4.16 U.S. list price charge per rack for each Plaque-A-Rack order (includes 2 plaques on 2 sides); special orders for plaques on all four sides have a \$8.32 U.S. list price (includes 2 plaques on 4 sides)
- Plaques may also be ordered separately at \$1.04 U.S. list price each
- Plaques are placed horizontally on two opposite sides of the rack along the top most edge
- Plaques snap on for a tight fit; won't fall off during normal use
- Plaques can be removed if necessary and are re-usable
- Allow ten working days for shipment of your standard order
- Plaquet racks sold in full case quantities only
- Please allow 4-6 weeks from approval of sample for custom plaques
- Custom imprinted plaques are \$1.04 U.S. list price each with an additional \$50 U.S. net price setup fee
- An additional \$142 U.S. net price dye charge will apply to any plaque order that does not include racks
- For custom color coding, please specify which color is to be used for each rack
- All plaque sales are final

How To Order

Follow instructions below and refer to the charts on the facing page for catalog numbers.

- Step 1:** Choose the glass rack that best fits your glassware.
- Step 2:** Plaque-A-Rack glass racks are identified by an "X" preceding the standard glass rack catalog number (example: "X"RG25-1 25-Compartment Plaque-A-Rack glass rack with one extender).
- Step 3:** Choose the different imprints you want from the types of plaque imprints available.
- Silhouette
 - Name of glassware
 - Location
- Step 4:** Place the three digit plaque catalog imprint product number next to the standard glass rack catalog number.

EXAMPLE:

Rack Choice: RG25-1
 Silhouette: Red Wine
 Glassware Name: Red Wine
 Location: Service Bar
 Catalog No: XRG25-1 204 304 104

Standard Color

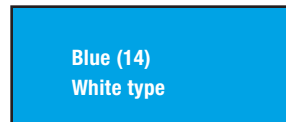

Custom Colors

- Minimum order 24 pieces

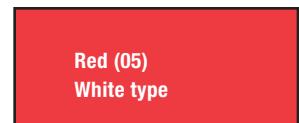
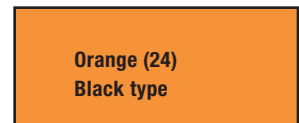
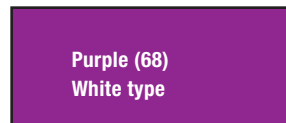































LOCATION

GLASS RACK

CAT. NUMBER	IMPRINT	CATALOG NUMBER		
100	(BLANK)	XRG16	XRG25-2	XRG36-4
101	KITCHEN	XRG16-1	XRG25-3	XRG9
102	DINING	XRG16-2	XRG25-4	XRG9-1
103	BANQUET	XRG16-3	XRW30	XRG9-2
104	SERV. BAR	XRG16-4	XRW30-1	XRG9-3
105	POOLSIDE	XRW20	XRW30-2	XRG49
106	STORAGE	XRW20-1	XRW30-3	XRG49-1
107	RM SERV	XRW20-2	XRG36	XRG49-2
108	BALLROOM	XRW20-3	XRG36-1	XRG49-3
109	BAR	XRG25	XRG36-2	
110	HOUSEKEEPING	XRG25-1	XRG36-3	

SILHOUETTE		NAME OF GLASS		SILHOUETTE		NAME OF GLASS	
CAT.#	IMPRINT	CAT.#	IMPRINT	CAT.#	IMPRINT	CAT.#	IMPRINT
PLQ	(BLANK)	PLQ	(BLANK)	214		314	MUG
201		301	CHAMPAGNE	215		315	FOOTED CUP
202		302	CHAMPAGNE	217		317	HI BALL
203		303	WHITE WINE	218		318	ICED TEA
204		304	RED WINE	219		319	FLUTED
205		305	ROCKS	221		321	GOBLET
206		306	WATER	222		322	WINE
207		307	COOLER	223		323	MARGARITA
208		308	PILSNER	224		324	BEER
209		309	STEIN	226		326	HURRICANE
210		310	PARFAIT	227		327	MARTINI
211		311	BRANDY	228		328	CORDIAL
212		312	TULIP	229		329	DESSERT
213		313	SOUR	230		330	CUP
				235		335	OLD FASHION
						633	COFFEE CUP



BUS BOXES

Tote Boxes

- Unique reinforced rims reduce bending, bowing, and breaking
- Comfort Curve™ handles for a sure, comfortable grip
- Contour lid design allows easy box-on-box stacking
- Available in 8 different colors for HACCP zone use
- NSF Listed



**NEW
PRODUCT**

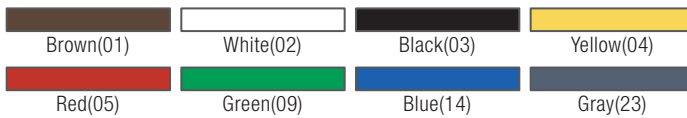

Prod No	Description	Color	Pack	Cs Wt/Cube
Tote Boxes				
N44010 Δ	Tote Box 15" x 20" x 5" Deep	01, 02, 03, 04, 05, 09, 14, 23	12 ea	23.00/3.49
N44011 Δ	Tote Box 15" x 20" x 7" Deep	01, 02, 03, 04, 05, 09, 14, 23	12 ea	27.50/3.82
N44012 Δ	Universal Lid	01, 02, 03, 04, 05, 09, 14, 23	12 ea	11.50/0.95

NSF Listed products are designated with a Δ and may be prefixed with an N



Save-All™ Compartmented Bus Boxes

- Silverware tray and heavy-duty bus boxes feature contoured handles for easy handling
- Scuff, grease, and stain-resistant
- Silverware Tray measures 21.25" x 11.5" x 3.75" H
- 0386 Save-All Bus Box has separate compartments, one for flatware, one for plates and debris; measures 22" x 17" x 5" H
- Dishwasher safe



Bus Boxes

- Unique reinforced rims reduce bending, bowing, and breaking – protecting your valuable tableware investment
- Comfort Curve™ handles for a sure, comfortable grip
- Contour lid design allows easy box-on-box stacking
- 44010, 44011, 44012 in White are NSF Listed



44011SKD

Prod No	Description	Color	Pack	Cs Wt/Cube
Save-All Compartmented Bus Boxes				
1071	Save-All Silverware Tray	23	6 ea	10.53/1.99
0386	Save-All Bus Box	23	12 ea	34.90/3.68
Bus Boxes				
44010	Bus Box 15" x 20" x 5" Deep	01, 02, 03, 23	12 ea	24.80/3.49
44011	Bus Box 15" x 20" x 7" Deep	01, 02, 03, 23	12 ea	26.56/3.82
44012	Universal Lid	01, 02, 03, 23	12 ea	12.90/0.95
44010SKD*	Bus Box Skid 15" x 20" x 5" Deep	03, 23	300 ea	585.00/73.94
44011SKD*	Bus Box Skid 15" x 20" x 7" Deep	03, 23	240 ea	550.08/64.17

*Note: 44010SKD, 44011SKD cannot ship UPS/FedEx Ground



CARLISLE
FOODSERVICE PRODUCTS

PROVEN
EFFICIENT
RELIABLE
**CLEANING
TOOLS**

Trust Carlisle's equipment cleaning brushes and kitchen tools to help keep your food service operation healthy, safe and profitable. These products are another way Carlisle helps you make work easy.



SPARTA



The Right Brush For Every Job

We offer more than 2,000 brushes and cleaning tools, each ergonomically designed with the end user in mind to provide optimum cleaning results for *you*.

Since 1908

we've been manufacturing high-quality brushes and cleaning tools. We have developed unmatched expertise, consistently delivering innovative cleaning solutions.

The Highest Quality

and best suited materials for efficient use and durability. These outstanding Sparta Brush features save you time and money.

Custom Designed

for each specific cleaning application.

Proven

Sparta Brush quality excels in foodservice and food processing including fine restaurants, hotels, schools, hospitals, lunch counters, cafeterias, supermarket bakeries, meat departments and delicatessens.

Our Commitment

to the customer never ends, and our mission is to give 100% customer satisfaction.

SPARTA[®]
BRUSH



Maintain a healthy foodservice environment with the **Sparta® 21 Key Brush** solution!

This program is specifically tailored for food service operators to help you prevent the spread of food-borne illness and comply with FDA Food Codes

PASTRY & BASTING



#1 Hot Use
40374



#2 Cold Use
40401



#3 Silicone Basting Brush
40405

FLOOR CLEANING



#4 24" Double Foam Rubber Squeegee
40082



#5 Hi-Lo™ Floor Scrub
40423



#6 Duo-Sweep™ Angle Broom
36885



#7 24" Omni® Floor Sweep
41881

FOOD PREPARATION



#8 Vegetable Brush
40164



#9 6" Cutting Board Brush
40521

GENERAL CLEANUP



#10 8" Polyester Scrub Brush
40541



#11 20" Polyester Scrub Brush
40501



#12 Scratch Brush with Scraper
40671

KITCHEN EQUIPMENT



#13 Broiler Master Brush
40290



#14 L-Tipped Teflon Fryer Brush
40111

BEVERAGE SERVICE



#15 12" Carafe/Bottle Brush
40000



#16 Coffee Decanter Brush
40025

FLOOR DRAIN CLEANING



#17 Floor Drain Brush
40146



#18 36" Plastic Drain Brush Handle
40236



#19 Drain Opening Tool
40144

WASHROOM & PERSONAL HYGIENE



#20 Hand and Nail Brush
40020



#21 Polyester Bowl Brush
40140

21 Key Brush Kit - 990021KIT00

21 KEY BRUSHES

#3 Silicone Basting Brush **40405**



#13 Broiler Master Brush **40290**



#14 L-Tipped Teflon Fryer Brush **40111**



#12 Scratch Brush w/ Scraper **40671**



#1 Hot Use **40374**



#2 Cold Use **40401**



#5 Hi-Lo Floor Scrub **40423**



#17 Floor Drain Brush **40146**



#18 36" Plastic Drain Brush Handle **40236**



#19 Drain Opening Tool **40144**



#10 8" Polyester Scrub Brush **40541**



21 Key Brush Kit - 990021KIT00

#16 Coffee Decanter
Brush **40025**



#15 12" Carafe/Bottle
Brush **40000**



#20 Hand & Nail
Brush **40020**



#21 Polyester Bowl
Brush **40140**



#8 Vegetable
Brush **40164**



#11 20" Polyester
Scrub Brush **40501**



#9 6" Cutting
Board Brush **40521**



#4 24" Double Foam
Rubber Squeegee **40082**



#6 Duo-Sweep™ Angle
Broom **36885**



#7 24" Omni® Floor
Sweep **41881**





SMALLWARES BRUSHES

Atlas Multi-Purpose Brushes

- Versatile design for a wide variety of applications
- Multiple trim angles on bristles give you better surface contact for better cleaning
- Available with ergonomic pistol grip handles in 8" and 20" lengths
- Rugged plastic handles and crimped staple set polyester bristles will not absorb oils or moisture
- Base resins used to produce blocks and bristles are made of FDA compliant materials



Cutting Board Brushes

- Ergonomically shaped handles and crimped staple set polyester bristles are rugged and will not absorb food oils or moisture
- Segregate brushes and boards by color to help prevent cross contamination
- Base resins used to product blocks and bristles are made of FDA compliant materials

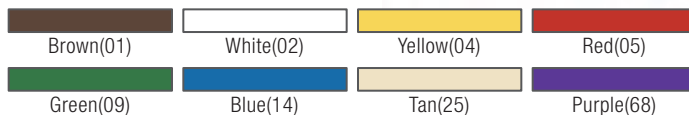
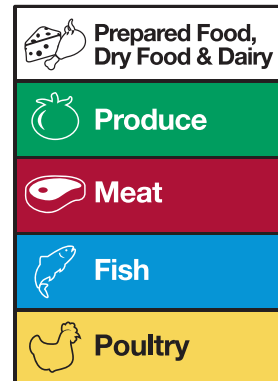

Prod No	Description	Recommended Cleaning	Color	Pack	Cs Wt/Cube
Atlas Multi-Purpose Brushes					
40000	12" Handle, 2.75" Round with Soft Polyester Bristles	Drinkware/Dishes	02, 04, 05, 09, 14	12 ea	2.40/0.65
40001	16" Handle, 3.25" Round with Soft Polyester Bristles	Drinkware/Dishes	01, 02, 04, 05, 09, 14, 68	12 ea	5.00/0.65
40002	16" Handle, 3.5" x 5" Oval with Polyester Bristles	Pots/Pans/Tanks	02, 04, 05, 09, 14	6 ea	4.00/0.77
40003	30" Handle, 3.5" x 5" Oval with Polyester Bristles	Pots/Pans/Tanks	02, 04, 05, 09, 14	6 ea	6.75/1.62
40004	16" Handle, 3" Round with Polyester Bristles	Pots/Pans/Tanks	02, 04, 05, 09, 14	6 ea	3.60/0.65
40006	30" Handle, 3" Round with Polyester Bristles	Pots/Pans/Tanks	02, 04, 05, 09, 14	6 ea	5.00/1.62
40005	16" Handle, 4" Round with Polyester Bristles	Pots/Pans/Tanks	02, 04, 05, 09, 14	6 ea	4.55/0.65
40007	30" Handle, 4" Round with Polyester Bristles	Pots/Pans/Tanks	02, 04, 05, 09, 14	6 ea	5.00/1.62
40010	16" Handle, 5" Round with Polyester Bristles	Pots/Pans/Tanks	02, 04, 05, 09, 14	6 ea	5.25/1.06
40008	30" Handle, 5" Round with Polyester Bristles	Pots/Pans/Tanks	02, 04, 05, 09, 14	6 ea	6.75/1.62
Cutting Board Brush					
40521	6" Cutting Board Brush with Polyester Bristles, 1.38" trim		02, 04, 05, 09, 14, 25	12 ea	5.20/0.30

SMALLWARES BRUSHES

Sparta® Glass Washing Brushes

- All plastic construction helps prevent glasses from being chipped or broken and helps seal out moisture
- Positive-suction, molded plastic base provides a tight grip in sinks and on countertops
- Heavy-duty polyester bristles with densely filled dome top holds up to extreme use

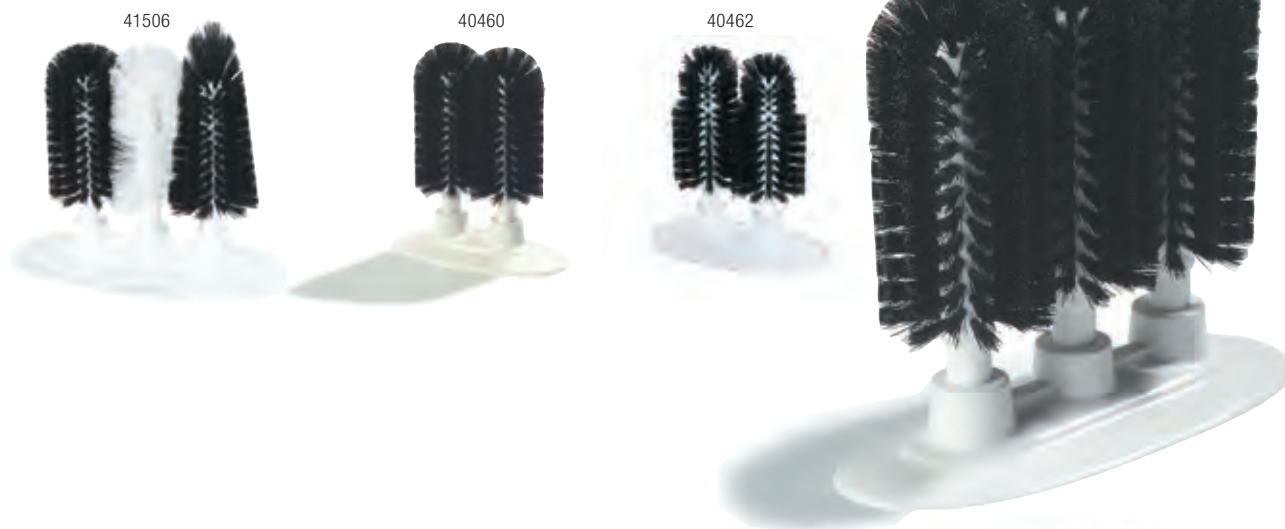

Sparta Bottle & Jar Brushes

- Wirewound brushes have a small diameter handle and soft bristles for easy and delicate cleaning of jars, bottles, and glasses with smaller openings
- 40415 Bottle Brush is perfect for cleaning wine bottles, ketchup bottles, squeeze bottles, etc.



Prod No	Description	Recommended Cleaning	Color	Pack	Cs Wt/Cube
Sparta Glass Washing Brushes					
40460	8" Twin Glass Washer, 2.88" trim	Drinkware	03	6 ea	5.00/1.25
40461	8" Triple Glass Washer, 2.88" trim	Drinkware	02, 03	6 ea	10.00/1.87
41506	9.5" Pilsner, Hurricane & Standard Style Triple Glass Washer	Drinkware	00	6 ea	10.15/1.87
40465	Standard Refill Brush	Drinkware	03	12 ea	3.20/0.45
40462	Shot Glass Cleaning Brush	Drinkware	03	6 ea	6.50/1.25
Sparta Bottle & Jar Brushes					
40466	12" Handle Pint Bottle Brush with Polyester Bristles, 2.5" - 3.5" trim	Jars/Carafes/Bottles	00	12 ea	4.00/0.65
40467	16" Handle Quart Bottle Brush with Polyester Bristles, 3" - 4.25" trim	Jars/Carafes/Bottles	02	12 ea	5.00/0.65
40468	16" Handle Half Gallon Brush with Polyester Bristles, 4" - 4.5" trim	Jars/Carafes/Bottles	00	12 ea	5.26/1.28
40415	16.5" Handle Small Bottle Neck Brush with Soft Nylon Bristles	Small Neck Bottles	00	12 ea	1.70/0.34



SPECIAL EQUIPMENT BRUSHES

Hot Dog Roller Brush

- Special "V" shaped stiff polyester bristle design cleans hot dog rollers and connecting points at the side walls at one time
- Rids hot dog roller grills of unsanitary grease build-up that could result in mechanical problems



High Temp Fryer Brushes

- Made of stiff, Teflon®** bristles that withstand temperatures up to 500°F
- Saves time since equipment can be cleaned while hot
- Plastic handles stay cool to the touch
- 40110 Fryer Brush is 28" long to reach tight, narrow spaces
- 40112 Looped Brush cleans fryer bottoms easily
- 40111 and 40116 L-Tipped Fryer Brush for cleaning hot coils

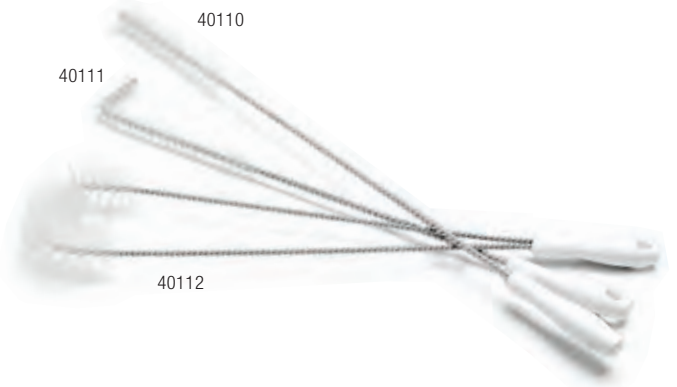

High Temp Waffle, Panini Griddle & Equipment Brushes

- Made of stiff, Teflon®** bristles that withstand temperatures up to 500°F
- Saves time since equipment can be cleaned while hot
- Plastic handles stay cool to the touch
- 40114 has extra stiff bristles for cleaning waffle irons, griddles, and grills while still hot
- 40115 is a pastry style brush designed for buttering and basting hot surfaces
- 40113 Utility Brush for cleaning hot vats, utensils and other equipment



Standard(00)

Prod No	Description	Trim	Color	Pack	Cs Wt/Cube
Hot Dog Roller Brush					
41169	24" L Hot Dog Roller Brush	2"	00	12 ea	6.05/0.34
High Temp Fryer Brushes					
40110	28" Straight Fryer Brush with Teflon Bristles	1.38"	00	12 ea	5.90/0.34
40112	24" Looped Fryer Brush with Teflon Bristles	2"	00	6 ea	3.85/0.34
40111	23" L-Tipped Fryer Brush with Teflon Bristles	.88"	00	12 ea	5.35/0.37
40116	23" L-Tipped Fryer Brush with Teflon Bristles	2"	00	12 ea	14.00/1.01
High Temp Waffle, Griddle & Equipment Brushes					
40114	3" Wide Brush with Teflon Bristles	.94" - 1"	00	12 ea	2.35/0.16
40115	1" Round Brush with Teflon Bristles	2"	00	12 ea	1.85/0.10
40113	20" Utility Brush with Teflon Bristles	2"	00	12 ea	11.90/1.06

*Teflon® is a registered trademark of E.I. DuPont® DeNemours & Co., Inc.
 NOTE: Heat coil must be turned off prior to using high temperature brushes

Sparta Coffee Service Brushes

- Brushes are designed to clean all glass and Pyrex® pots and dispensers
- 40025 Coffee Decanter Brush is shaped like the inside of the most popular coffee decanters for quick and easy use
- Use 40673 Urn Brush for quick and easy clean-up of glass urns on coffee urns
- 40154 Creamer and Percolator Brush is designed for cleaning spouts and tubing on percolators, hot beverage servers, and creamers
- 40153 Curved Coffee Maker Brush is a semi-circular wire wound brush that contours to the inside of coffee pots



Spouts, Pumps & Valves - Stiff Polyester Bristles

Tee, Fitting, and Valve Brush (40180)

- Perfect for straight pipes, tees, and valves

Condiment Dispenser Spout Brush (40155)

- Flexible wire for efficient cleaning of bacteria prone spouts

Condiment Dispenser Plunger Brush (40156)

- Rose-bud tip for efficient dispenser cleaning

Beer Tap Line Brush (40157)

- Great for maintaining quality control of beer on tap

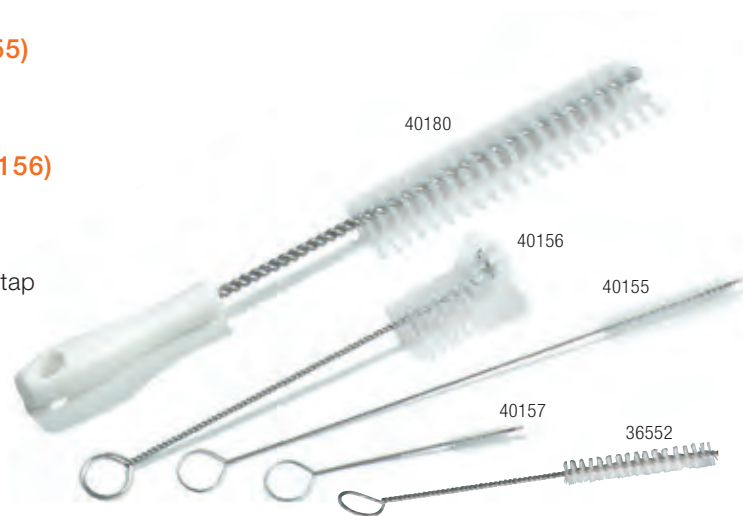

Prod No	Description	Recommended Cleaning	Color	Pack	Cs Wt/Cube
Sparta Coffee Service Brushes					
40025	16" Coffee Decanter Brush with Soft Polyester Bristles, 4.6" - 6.4" trim	Coffee Decanter	00	6 ea	3.65/1.34
40673	25" Handle Urn Brush with Polyester Bristles, .63" trim	Coffee Urn & Tap	00	12 ea	0.94/0.07
40154	12" Creamer Brush with Polyester Bristles, 1" x 1.5" trim	Coffee Spout	00	24 ea	0.66/0.38
40153	10" Curved Coffee Maker Brush with Soft Polyester Bristles, 1.5" trim	Coffee Maker	00	12 ea	3.00/0.44
Spouts, Pumps & Valve Brushes					
36552	8" Spout Brush	Spouts/Faucets	00	144 ea	4.62/0.32
40157	5.25" Beer Tap with Polyester Bristles, .25" trim	Beer Taps	00	24 ea	0.30/0.05
40180	15" Valve & Fitting with Polyester Bristles, 1" trim	Valves & Fittings	02	12 ea	4.00/0.20
40155	13" Spout Brush with Polyester Bristles, .44" trim	Condiment Pumps	00	12 ea	0.46/0.13
40156	10.5" Plunger Brush with Polyester Bristles, .94" trim	Condiment Pumps	00	12 ea	0.85/0.13



EQUIPMENT CLEANING BRUSHES

Wok/Gong Utility Brushes

- Clean woks and electric griddles; designed specifically for high heat cleaning
- Wood block handle available in two lengths
- Stiff palmyra bristles are excellent for general cleaning



Low Temperature Equipment Brushes

- 40040 and 40042 Tank and Kettle Brushes have bristles on all sides to provide complete cleaning and can be used with a handle to reach the bottom of kettles and tanks
- 40150 Kettle Drain Valve Brush is a perfect solution for cleaning bacteria prone areas of kettles
- 40152 Cool Temperature Fryer Brush has the same shape as our High Temp Fryer Brush(40111) but is used in cool cleaning



Dishwasher Machine Brush

- Long handle reaches spray arms for more thorough cleaning



Standard(00)

Prod No	Description	Recommended Cleaning	Color	Pack	Cs Wt/Cube
Wok/Gong Utility Brushes					
45463	8.5" Utility Scrub Brush with Stiff Palmyra Bristles	Wok/Gong/Electric Griddles	00	12 ea	7.00/0.70
45493	20" Utility Scrub Brush with Stiff Palmyra Bristles	Wok/Gong/Electric Griddles	00	12 ea	9.30/1.35
Clean-Up Brushes					
45463	8.5" Utility Scrub Brush with Stiff Palmyra Bristles	Wok/Gong/Electric Griddles	00	12 ea	7.00/0.70
45493	20" Utility Scrub Brush with Stiff Palmyra Bristles	Wok/Gong/Electric Griddles	00	12 ea	9.30/1.35
Low Temperature Equipment Brushes					
40040	Tank & Kettle Brush with Nylon Bristles, 5.25" x 7.5" trim	Kettle & Tank	00	12 ea	10.66/1.06
40042	Tank & Kettle Brush with Nylon Bristles, 5.5" x 9.5" trim	Kettle & Tank	00	12 ea	15.00/1.28
40150	28" Kettle Valve with Stiff Polyester Bristles, 1.38" trim	Kettle Valve	00	12 ea	5.65/0.36
40152	23" Cool L-Tipped Fryer with Polyester Bristles, .88" trim	Fryer	00	12 ea	5.10/0.34
Dishwasher Machine Brush					
40028	35" Dishwasher Spray Arm with Polyester Bristles, 1" trim	Dishwasher	00	12 ea	6.00/0.55

Bake Pan Lip Brush

- Easy cleaning of rolled lips and edges on baking pans
- Stiff polyester bristles patterned in a flat V-shape for maximum pan contact
- Contoured handle provides a convenient grip and protects hands from metal edges on pans and other equipment



40024

Vegetable Cutter Brushes

- 40529 has 2.5" long, extra stiff nylon bristles reach through the grid of stainless steel cutters
- 40532 has 4.25" long, extra stiff, nylon bristles



40532



40529

Iron Handle Brush

- Pointed edge to allow cleaning in corners
- Iron style grip is ergonomically designed for comfort and light or medium duty scrubbing



36289



Prod No	Description	Recommended Cleaning	Color	Pack	Cs Wt/Cube
Bake Pan Lip Brush					
40024	6" Bake Pan Lip Brush with Polyester Bristles, 1" trim	Baking Pans	02, 04, 05, 09, 14	12 ea	5.00/0.30
Cutter Brush					
40529	2.5" Vegetable Cutter Brush with Nylon Bristles, 2" trim	Lettuce & Onion Cutters	00	12 ea	6.00/0.30
40532	4.25" Universal Onion/Lettuce Brush	Lettuce & Onion Cutters	00*	8 ea	3.82/0.77
Iron Handle Brush					
36289	6" Iron Handle Brush with Polypropylene Bristles	Medium Scrubbing/Corner Areas	00	48 ea	18.24/0.70



EQUIPMENT CLEANING

Toothbrush Style Utility Brushes

- Narrow profile cleans tight kitchen spaces and around ceramic tile
- Available in a choice of .5" long stiff nylon bristles for normal cleaning; stainless steel or brass bristles for tougher cleaning jobs



Butcher Block Brushes

- Aggressive tempered steel wire bristles scrape away contaminated layers of wooden butcher blocks and wooden cutting boards



Meat Slicer Cleaning Tool

- Keeps hands and fingers away from slicer blade
- Easy clean-up of slicers without disassembling slicer
- Slicer tool has scraper on one end for scraping hardened foods
- Scrub pad wraps around meat slicer tool for a one-time thorough cleaning



Prod No	Description	Recommended Cleaning	Color	Pack	Cs Wt/Cube
Toothbrush Style Utility Brushes					
40674	7" Plastic Handle with .5" Nylon Bristles	Tile/General Purpose	00	12 ea	0.50/0.03
40675	7" Plastic Handle with .5" Stainless Steel Bristles	Ovens/Grills/Small tough areas	00	12 ea	0.55/0.02
41270	7" Plastic Handle with .5" Brass Bristles	Ovens/Grills/Small tough areas	00	12 ea	1.00/0.06
Butcher Block Brushes					
40676	4" x 9" Brush with Flat Steel Bristles	Butcher Block	00	12 ea	23.75/1.05
45781	2.63" x 7.75" Brush with Steel Bristles	Butcher Block	00	12 ea	10.70/0.35
Meat Slicer Cleaning Tool					
40728	Meat Slicer Cleaning Tool	Meat Slicer Blade	25	12 ea	3.50/0.23
40729	Meat Slicer Scrub Pad	Meat Slicer Blade	08	12 pk	3.41/1.14

DISHWARE CLEANING



Scrubs & Sponges

- 36752 and 36753 are a long-lasting 400 series stainless that won't rust or splinter
- 36396: aggressive pad for use in place of steel wool - not recommended for coated cookware, soft plastics, fine china or polished stainless steel as scratching can occur



Dish Brushes

- 40413 has a 180° brush head and full end bristles to prevent splash back when in use cleaning dishes, utensils and fry pans
- 3610140 is perfect for scraping off food before placing in dishwasher



Prod No	Description	Recommended Cleaning	Color	Pack	Cs Wt/Cube
Scrubs & Sponges					
36396	9" x 6" x .25" Medium Duty Scour Pad 10 ea/pack, 6 packs/case	Pots/Pans/Equipment	08	6 ea	7.00/0.83
36752	35 g Stainless Steel Scrub, 400 Series 12 ea/pack, 6 packs/case	Pots/Pans/Oven	00	6 ea	7.00/0.47
36753	50 g Stainless Steel Scrub, 400 Series 12 ea/pack, 6 packs/case	Pots/Pans/Oven	00	6 ea	11.50/1.26
365501	8.25" x 4.25" x 2.25" Extra Large Sponge	Dishes	00	24 ea	1.44/2.15
Dish Brushes					
40413	12" Handle Dish Brush with Polyester Bristles, 2.75" trim	Dishes/Utensils	00	12 ea	4.00/0.65
367600TC	11" Handle Dish Brush with Polyester Bristles, 2.75" trim	Dishes/Utensils	02	6 ea	1.90/0.38
3610140	8" Dish & Sink Brush	Dishes/Utensils	00	48 ea	7.68/0.46



EQUIPMENT CLEANING

Oven & Grill Brushes

- Wire brushes and stainless steel metal scrapers make quick and easy removal of heavy carbon deposits, rust, and burned-on food build up

Broiler Master

The best grill brush available and master of all grill cleaning tools. Rust-proof bristles are embedded in a rugged specially treated hardwood block for long-lasting cleaning power.



Double Broiler King 40294

- Sturdy construction with two heads featuring carbon steel flat bristles on one side and carbon steel wire bristles on the other; bolted together on a heavy hardwood handle for very heavy use

Oven Brush 41520 & 40291

- Crimped brass wire bristles and a full length stainless steel scraper for cleaning high-temperature stack ovens

Oven Brush 40293

- Crimped brass wire bristles and a full length aluminum scraper on a low-profile head for cleaning the narrow spaces inside pizza ovens

Pizza/BBQ Oven Brush 45772

- Steel wire bristles and permanent 39" hardwood handle

Oven & Grill Brush 363725

- Flat wire stainless steel bristles, oven scraper and 30" handle



40291



40294



363725



TOP SELLER



40290



45772

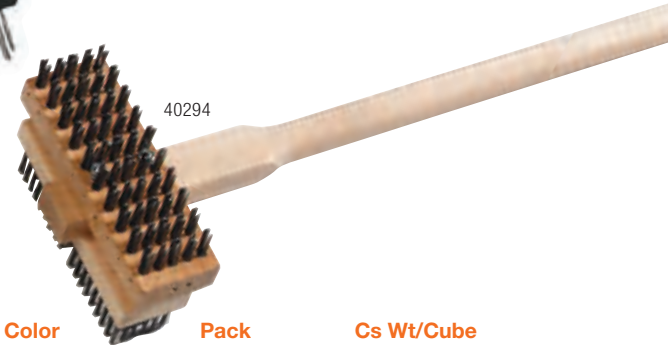

40294

Standard(00)

Prod No	Description	Color	Pack	Cs Wt/Cube
Oven & Grill Brushes				
40026	8.5" Broiler Master Brush, Carbon Steel Bristles with 30" Handle	00	6 ea	15.35/1.62
40290	8.5" Broiler Master Brush, Stainless Steel Bristles with 30" Handle	00	6 ea	15.02/1.62
40294	8" Double Broiler King, Carbon Steel Flat & Wire Bristles with 48" Handle	00	2 ea	7.00/1.53
41520	8.5" Oven Brush & Scraper, Brass Wire Bristles with 42" Handle	00	1 ea	2.60/0.55
40291	8.5" Oven Brush & Scraper, Brass Wire Bristles (Head Only)	00	12 ea	13.00/0.44
40293	10" Oven Brush & Scraper, Brass Wire Bristles (Head Only)	00	12 ea	10.70/0.22
45772	5.5" Pizza/BBQ Oven Brush, Carbon Steel Bristles and 33" Handle	00	12 ea	19.00/1.21
363725	8" Oven Brush with Scraper, Flat Wire Stainless Steel Bristles with 30" Handle	00	1 ea	3.00/0.64

NOTE: Equipment must be turned off prior to using Oven & Grill Brushes

*40291 & 40293 do not include handles; use with handle 40275 shown on page 278



40710

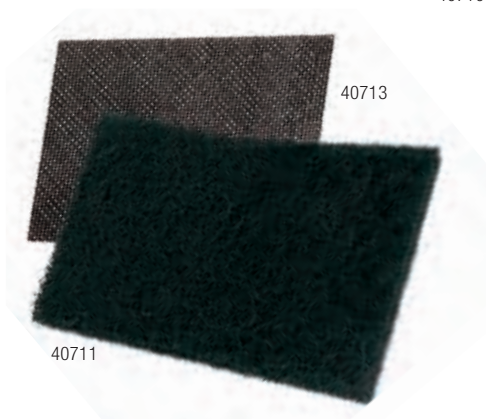

40711

40713

Grill Bricks, Screens & Polishing Pads

- Apply with cooking oil to protect the grill, cure and remove excess cooked-on foods
- 40710 Grill Brick is a fast, efficient, and sanitary way to clean hot or cold grills
- Plastic wrapping on Grill Brick dissolves to eliminate mess
- 40713 Grill Screen and 40711 Grill Polishing Pad attach to the 40712 Grill Pad Holder for a complete grill maintenance system



40712

Scratch Brushes

- Compact profile for heavy scraping and cleaning in tight, narrow spaces; provides quick, aggressive removal of grease and deposits
- Available with wood handles for cleaning hot grills and ovens
- Available in nylon, stainless steel, or carbon steel wire bristles for normal to tougher cleaning jobs



45779

40671

40670

40672

40027

45571

Standard(00)

Prod No	Description	Handle	Color	Pack	Cs Wt/Cube
Grill Bricks, Screens & Polishing Pads					
40710	3.5" x 4" x 8" Grill Brick	—	00	12 ea	8.00/0.92
40711	4" x 5" x .25" Grill Polishing Pads, 10 ea/pack, 6 pks/case	—	00	6 pks	4.60/0.70
40712	Grill Pad Holder	Plastic	00	10 ea	6.00/0.32
40713	4" x 5.5" Grill Screen, 20 ea/pack, 10 pks/case	—	00	10 pks	3.75/0.13
Scratch Brushes					
45779	11" Brush & Scraper with Carbon Steel Bristles	Wood	00	12 ea	7.00/0.34
40671	11.5" Scratch Brush & Scraper with Carbon Steel Bristles	Plastic	00	12 ea	4.50/0.22
40670	11.5" Scratch Brush with Carbon Steel Bristles	Plastic	00	12 ea	4.06/0.22
40672	11.5" Scratch Brush & Scraper with Stainless Steel Bristles	Plastic	00	12 ea	4.60/0.22
40027	11.5" Scratch Brush with Nylon Bristles	Plastic	00	12 ea	3.10/0.22
45571	20" Brush & Scraper with Carbon Steel Bristles	Wood	00	12 ea	10.00/4.14

NOTE: Equipment must be turned off prior to using Scratch Brushes



HAND & NAIL

Reduce the risk of foodborne illness breakouts with our hand & nail brushes. Every wash station in a foodservice operation should have a Carlisle Hand & Nail Brush.

Hand & Nail Brushes

- Designed to promote vital cleansing of hands for foodservice personnel
- 40020 has stiffer center bristles for a more thorough cleaning under fingernails and longer bristles along the sides clean finger's top and bottom
- 40021 kit includes 5" x 2" brush, cord to secure brush in place, hanging hook and an adhesive backed hand washing instructions decal in English and Spanish



40021



40020



Standard(00)

Prod No	Description	Recommended Cleaning	Color	Pack	Cs Wt/Cube
Hand & Nail Brushes					
36239	3.5" Plastic Block Hand & Nail Brush	Hands & Nails	00	24 ea	1.68/0.09
40020	5" Handle Hand & Nail with Polyester Bristles	Hands & Nails	00	12 ea	4.30/0.27
40021	5" Handle Hand & Nail Brush Kit	Hands & Nails	00	12 ea	5.45/0.44
40022	36" Replacement Coiled Vinyl Security Line	—	00	12 ea	0.50/0.17
40023	Replacement Hook only for Hand & Nail Brush Pack	—	00	12 ea	1.00/0.05

TABLETOP & COUNTER CLEANING

Square Steri- & Suds-Pail®

- 3, 6 and 8 quart pails meet board of health & HACCP guidelines for dedicated containers
- Use Red Steri-Pails for sanitizing solutions, Green Suds-Pails for cleaning solutions
- Pails have both standard and metric measurements on the interior walls
- Helper handles for better control
- Instructions for mixing and using sanitizing solutions is printed on the pails in English and Spanish
- Made of sturdy, dishwasher safe plastic



Microfiber Cleaning/Polishing Cloths

- 36333 is great for mirrors, windows and metallic surfaces
- 36334 is great for general cleaning



Prod No	Description	Color	Pack	Cs Wt/Cube
Square Steri- & Suds-Pail				
11828	3 qt Square Steri-Pail	05	12 ea	4.47/1.31
11829	6 qt Square Steri-Pail	05	12 ea	7.25/2.24
11830	8 qt Square Steri-Pail	05	12 ea	12.63/3.03
11831	3 qt Square Suds-Pail	09	12 ea	4.47/1.31
11832	6 qt Square Suds-Pail	09	12 ea	7.25/2.24
11833	8 qt Square Suds-Pail	09	12 ea	12.63/3.03
Microfiber Cleaning/Polishing Cloths				
36333	16" x 16" Microfiber Suede Polishing Cloth	14	12 ea	1.20/0.16
36334	16" x 16" Microfiber Terry Polishing Cloth	02, 04, 05, 09, 14	12 ea	1.20/0.17



SCRUB BRUSHES

All Purpose Utility Scrub Brushes

- Brushes offer a thick "pistol grip" block handle and short, stiff bristles for really tough cleaning
- Light-weight, break-resistant, "soak-proof" plastic handles are perfect for clean up in a foodservice environment
- Rugged construction with stapleset secure bristles

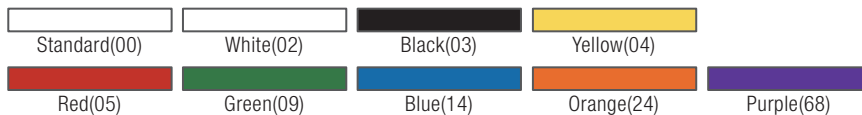

Prod No	Description	Recommended Cleaning	Color	Pack	Cs Wt/Cube
All Purpose Utility Scrub Brushes					
40541	8" Utility Scrub Brush with Polyester Bristles, 2" trim	Pots/Pan/Medium Scrubbing	02, 03, 04, 05, 09, 14, 24, 68	12 ea	6.80/0.65
40501	20" Utility Scrub Brush with Polyester Bristles, 2" trim	Pots/Pan/Medium Scrubbing	02, 03, 04, 05, 09, 14, 24, 68	12 ea	9.55/1.15
40545	8" Brush with Medium Stiff Polyester Bristles, 1.6" trim	Pots/Pan/Medium Scrubbing	00	12 ea	6.30/0.65
40546	8" Brush with Medium Stiff Polyester Bristles, 1.6" trim	Pots/Pan/Medium Scrubbing	02	12 ea	8.00/0.65
40542	8" Brush with Medium Stiff Nylon Bristles, 1.4" trim	Pots/Pan/Medium Scrubbing	00	12 ea	8.00/0.65
40500	20" Brush with Medium Stiff Nylon Bristles, 1.6" trim	Pots/Pan/Medium Scrubbing	00	12 ea	8.95/1.17

GENERAL CLEANING BRUSHES



General Clean-Up Brushes

- 45463, 45493 have hardwood block design with stiff palmyra bristles for heavy-duty scrubbing
- Light-weight plastic handles are break-resistant, soak-proof, sanitary, and economical.



TOP SELLER

36505



Ergonomic Hand Scrubs

- Ergonomic handles are designed for easy, no stress use
- Grips and bristles are designed to work in the most comfortable position and provide the most efficient cleaning
- Sturdy polypropylene handles with over-molded TPR Rubber are more sanitary and offer a sure grip even when wet
- Crimped bristles hold on to cleaning solutions



Prod No	Description	Recommended Cleaning	Color	Pack	Cs Wt/Cube
Clean-Up Brushes					
365015	6" Brush with Polypropylene Bristles, 1.38" trim	Pots/Pan/Medium Scrubbing	00	12 ea	4.00/0.29
36505	8.5" Brush with Polypropylene Bristles, 2" trim	Pots/Pan/Medium Scrubbing	00, 01, 14	12 ea	5.36/0.74
36505L	20" Brush with Polypropylene Bristles, 2" trim	Pots/Pan/Medium Scrubbing	00, 01, 14	12 ea	10.92/1.35
Ergonomic Hand Scrubs					
36506	8" Utility Scrub with Crimped Polypropylene Bristles, 2" trim	Pots/Pan/Medium Scrubbing	03	12 ea	6.68/0.72
36506L	20" Utility Scrub with Crimped Polypropylene Bristles, 2" trim	Pots/Pan/Medium Scrubbing	03	12 ea	9.19/1.25



HAND SQUEEGEES, SCRAPERS & DUSTERS

Hand Held Window Squeegees

- Double blade red thermal rubber blades and zinc plated steel frame yields superior performance at an affordable price
- Single blade, black special blend rubber for a streak free professional finish. Zinc plated steel frame with a long handle socket that is easy to hold and fits a tapered handle

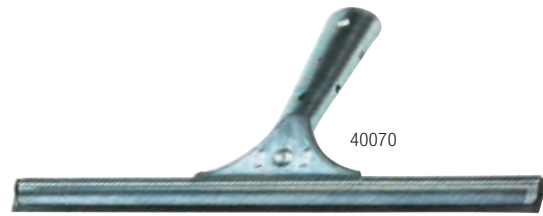

Window Scrapers

- Professional 4" wide scrapers
- 4" scraper has one sharp edge and one dull edge



Dusters

- 363404 features soft bristles for wall and ceiling dusting
- 45733 and 363156 duster have static active 100% lambswool; lambswool is electrostatically charged to attract lint and dust particles



Prod No	Description	Recommended Cleaning	Color	Pack	Cs Wt/Cube
Hand Held Window Squeegees					
41027	12" Double-Blade with Metal Handle	Windows	00	12 ea	9.40/0.20
40074	14" Double-Blade with Metal Handle	Windows	00	12 ea	9.55/1.30
40070	12" Single-Blade with Metal Handle	Windows	00	12 ea	9.50/1.07
40071	16" Single-Blade with Metal Handle	Windows	00	12 ea	11.00/1.39
Window Scrapers					
365117	Complete Scraper with 6" Plastic Handle Head & Blade	Tables/Floors/Windows	00	10 ea	3.10/0.26
365120	4" Replacement Blade Dispenser 10 per pack/10 packs per case	—	00	10 pks	2.00/0.89
Dusters					
363404	9" Flagged Polypropylene Duster	Walls/Ceilings	14	12 ea	4.92/4.48
365450	34" – 59" Metal Telescopic Handle	Attach to 363404	00	12 ea	6.96/0.24
45733	30" – 42" Telescopic Plastic Handle with Lambswool	Vents/Blinds	00	12 ea	4.00/0.30
363156	52" – 81" Telescopic Poly Wool Duster	Vents/Blinds	00	12 ea	3.96/0.61

COUNTER & RADIATOR BRUSHES

Counter Top & Radiator Brushes

- Wide variety of bristle and handle choices
- 36211's flagged bristles are ideal for cleaning up fine particles and dust
- 45411 .5" Narrow Profile Radiator Brush cleans counter tops, between equipment and counter tops, and refrigerated cooling coils



Standard(00)	Brown(01)	White(02)	Black(03)	Yellow(04)	
Red(05)	Green(09)	Blue(14)	Gray(23)	Orange(24)	Purple(68)

Prod No	Description	Recommended Cleaning	Color	Pack	Cs Wt/Cube
Counter Top & Radiator Brushes					
40480	8" Plastic Handle with White Polyester Bristles, 2.5" trim	Counters/Tables	01, 02, 04, 05, 09, 14, 24, 68	12 ea	7.66/1.35
40481	8" Plastic Handle with Black Polyester Bristles, 2.5" trim	Counters/Tables	00	12 ea	9.00/1.35
40485	8" Wood Handle with Horsehair & Polypropylene Blend Bristles, 2.5" trim	Counters/Tables	00	12 ea	9.00/1.35
36211	8" Plastic Counter Brush, 2.5" trim	Counters/Tables	23, 24	12 ea	9.00/1.37
45411	24" Radiator Brush with Horsehair-Polypropylene Bristles, 2" trim	Radiators/Narrow Areas	03	12 ea	4.10/0.33

HANDLE GUIDE

Prod No	Page	Description	Type of Handle	Recommended Handle
Equipment Brushes				
40026	252	30" Broiler Master	Threaded	020-30B
40290	252	30" Broiler Master	Threaded	020-30B
40291	252	8.5" Oven Brush & Scraper	Threaded	40275
40293	252	10" Pizza Oven Brush	Threaded	40275
41520	252	42" Oven Brush & Scraper	Threaded	020-40
Hand Squeegees				
40070	258	12" Single-Blade Squeegee	Tapered	365408
40071	258	16" Single-Blade Squeegee	Tapered	365408
40074	258	14" Double-Blade Squeegee	Tapered	365408
41027	258	12" Double-Blade Squeegee	Tapered	365408



CARLISLE
FOODSERVICE PRODUCTS

DURABLE
INNOVATIVE
VERSATILE
**FLOOR &
RESTROOM
PRODUCTS**

Carlisle offers durable, innovative and versatile solutions to maintain a clean and healthy environment with a complete line of brushes, brooms, and mopping supplies.





UPRIGHT BROOMS

Carlisle's upright brooms are **designed for extended use and offer superior performance.** Whether you're sweeping a lobby, kitchen floor or parking lot, we have a **high quality solution for you.**



Duo-Sweep® Angled

- For reaching into corners, along walls and into hard to reach areas
- Block made with tough & durable material that resists cracking, splitting, chipping
- Color coded angle brooms have one handle hole making them more hygienic and HAACP compliant
- Standard color (00) angle brooms have two handle holes; one angled, one upright

Recycled Angle Broom

- Contains 80% recycled flagged PET bristles and 60% recycled polypropylene copolymer shroud for increased stability
- Includes 48" durable vinyl coated metal handle with swivel hanging cap for storage

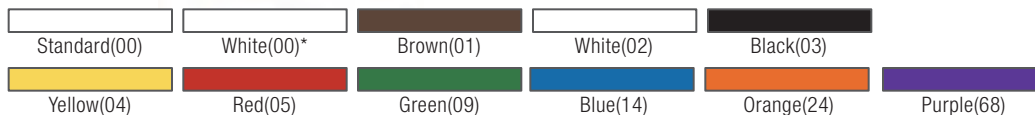

Prod No	Description	Bristle Length	Color	Pack	Cs Wt/Cube
Flagged Duo-Sweep Angle Brooms					
36861	6.5" Flagged Duo-Sweep Angle Broom with 30" Metal Handle	5.5" - 7"	00	12 ea	9.00/0.31
36865	12" Flagged Duo-Sweep Medium Duty Angle Broom with 48" Metal Handle	5.5" - 7"	00	12 ea	9.00/5.08
41082	12" Flagged Duo-Sweep Broom with 48" Fiberglass Handle	5.5" - 7"	01, 02, 04, 05, 09, 14, 24, 68	12 ea	28.00/4.89
36867	12" Flagged Duo-Sweep Angle Broom – (Head Only)	5.5" - 7"	00, 01, 02, 04, 05, 09, 14, 24	12 ea	12.70/1.56
Unflagged Duo-Sweep Angle Brooms					
36885	12" Unflagged Duo-Sweep Heavy Duty Angle Broom with 48" Metal Handle	5.5" - 7"	00	12 ea	21.04/0.31
41083	12" Unflagged Duo-Sweep Broom with 48" Fiberglass Handle	5.5" - 7"	01, 02, 04, 05, 09, 14, 24, 68	12 ea	21.34/4.87
36868	12" Unflagged Duo-Sweep 12" Angle Broom (Head Only)	5.5" - 7"	01, 02, 03, 04, 05, 09, 14	12 ea	12.44/1.43
Replacement Handles					
41225	48" Fiberglass Handle with Self-Locking Flex™ Tip – 1" D	—	00*, 03, 04, 05, 09, 14	12 ea	10.50/0.64
3620294	48" Plastic Coated Metal Threaded Handle – 15/16" D	—	03	12 ea	8.00/0.46
3620194	48" Powder Coated Metal Threaded Handle – 7/8" D	—	14	12ea	7.85/0.71
Recycled Angle Broom					
40650	12" Flagged Recycled Angle Broom with 48" Steel Handle	6" - 7"	00	12 ea	22.00/5.23



Flagged

Great for fine debris and use on smooth surfaces



Unflagged

Great for larger debris and rough surfaces: Bristles prevent ends from matting making this style perfect for back-of-house and outdoor applications

Duo-Sweep® Straight

- Two handle holes; upright hole for general purpose sweeping or angle hole for reaching into corners, along walls, or into hard to reach areas
- Flagged blue synthetic bristle for fine debris
- Stiff black synthetic bristles can be easily cleaned to extend broom life
- Guaranteed to outlast up to four corn brooms



Prod No	Description	Bristle Length	Color	Pack	Cs Wt/Cube
Flagged Duo-Sweep Brooms					
36859	7.5" Flagged Duo-Sweep Lobby Broom with 30" Black Metal Handle	4"	14	12 ea	9.00/1.33
36863	11" Flagged Duo-Sweep Light Industrial Broom with 48" Blue Metal Handle	4"	14	12 ea	15.50/4.63
36853	11" Flagged Duo-Sweep Light Industrial Broom (Head Only)	4"	14	12 ea	10.00/1.16
36883	13" Flagged Duo-Sweep Warehouse Broom with 48" Blue Metal Handle	7"	14	12 ea	17.00/3.92
36873	13" Flagged Duo-Sweep Warehouse Broom (Head Only)	7"	14	12 ea	9.00/1.47
Unflagged Duo-Sweep Brooms					
36860	7.5" Unflagged Duo-Sweep Lobby Broom with 30" Black Metal Handle	4"	03	12 ea	9.50/1.33
36864	11" Unflagged Duo-Sweep Light Industrial Broom with 48" Blue Metal Handle	4"	03	12 ea	16.00/4.47
36854	11" Unflagged Duo-Sweep Light Industrial Broom (Head Only)	4"	03	12 ea	10.90/1.01
36884	13" Unflagged Duo-Sweep Warehouse Broom with 48" Black Metal Handle	7"	03	12 ea	22.50/4.63
36874	13" Unflagged Duo-Sweep Warehouse Broom (Head Only)	7"	03	12 ea	9.00/1.47
Replacement Handles					
41225	48" Fiberglass Handle with Self-Locking Flex™ Tip – 1" D	—	00*, 03, 04, 05, 09, 14	12 ea	10.50/0.64
3620294	48" Plastic Coated Metal Threaded Handle – 15/16" D	—	03	12 ea	8.00/0.46
3620194	48" Powder Coated Metal Threaded Handle – 7/8" D	—	14	12ea	7.85/0.71



UPRIGHT BROOMS

Natural Corn Blend

- Heavy-duty lacquered wood handle
- 41354 heavy-duty warehouse broom has metal retaining bands and strong synthetic stitching for long-lasting use
- 41350 janitor broom has wide fan head for greater reach



100% Natural Corn

- Long lasting, durable broomcorn
- Heavy-duty lacquered wood handle



Synthetic Corn

- "X" shaped polypropylene bristles allow for superior sweeping on carpeting and entry mats
- Chemical and liquid resistant bristles; sustains temperatures to 225°F
- Wooden handle
- Metal top for added durability



Prod No	Description	Stitch	Color	Pack	Cs Wt/Cube
Natural Corn Blend Brooms					
36633	10" Corn Whisk	2-Sew	00	12 ea	4.40/0.42
3682	40" Corn Lobby Broom	3-Sew	00	12 ea	9.00/3.96
41349	55" Housekeeping Broom	3-Sew	67	12 ea	34.00/3.76
41352	55" Housekeeping Broom	4-Sew	00	12 ea	24.00/3.76
41350	56" Janitor Broom	5-Sew	67	12 ea	31.00/3.38
41354	56" Heavy Duty Warehouse Broom	4-Sew/1-Wire	67	12 ea	36.75/4.76
100% Natural Corn Broom					
40634	56" Janitor Broom	5-Sew	00	6 ea	15.00/2.57
Synthetic Corn Brooms					
45643	48" Maid Broom with Metal Top	Wire/Metal Top	04	12 ea	18.86/3.44

FLOOR SWEEPS

Only Carlisle offers a broad range of high quality professional floor sweeps that are durable and versatile.

Our manufacturing and industry expertise provides advantageous features you can't find elsewhere.

Omni Sweep®

- Unique patented design combines the features of fine, medium, and heavy floor sweeps in a convenient all-in-one design
- Effective on all types of floor surfaces
- Short, heavy bristles in front easily sweep up heavy debris
- Long, fine/medium bristles in back sweep fine dust and particles



Angled Pitch

Fast, effective sweeping

Sweep Complete™

- Versatile and durable floor sweep with built-in squeegee
- Comes with 60", 3-piece aluminum handle with brace
- Two handle holes extend the life of the sweep



Handles sold separately; see pages 276-279 for handle recommendations



Prod No	Description	Bristle Length	Handle	Color	Pack	Cs Wt/Cube
Omni Sweep – Plastic Block						
41880	18" Omni Sweep	1.63" - 2.38"	Threaded	00	12 ea	21.00/2.14
41881	24" Omni Sweep	1.63" - 2.38"	Threaded	00	12 ea	27.75/2.61
Sweep Complete Floor Sweeps						
36219618	18" Sweep Complete Floor Sweep with Squeegee	3"	Threaded	14	6 ea	17.47/1.95
36219624	24" Sweep Complete Floor Sweep with Squeegee	3"	Threaded	14	6 ea	21.12/2.37



FLOOR SWEEPS

Fine

- Recommended use: Fine powder and dust removal on polished wood, marble, terrazzo, or ceramic tile floors
- Heavy-duty plastic block resists splitting and cracking and is unaffected by moisture
- Soft, flagged bristles



36204824

Medium

- Recommended use: For general sweeping of smooth concrete, unpolished wood, vinyl and tile floors
- Heavy-duty plastic blocks resist splitting and cracking and are unaffected by moisture
- Horsehair-Polypropylene is a perfect blend of soft bristles for fine dust and stiff bristles for heavier debris
- Use black natural tampico bristles for heavy dirt
- Black polypropylene bristles resist oil and water while maintaining shape



40562

Handles sold separately; see pages 276-279 for handle recommendations



Prod No	Description	Handle	Color	Pack	Cs Wt/Cube
Fine Floor Sweeps					
36204818	18" Foam Block with Gray Polypropylene, 3" trim	Tapered	23	12 ea	23.00/1.95
36204824	24" Foam Block with Gray Polypropylene, 3" trim	Tapered	23	12 ea	26.00/2.46
Medium Floor Sweeps					
40564	18" Foam Block with Black Tampico, 3" trim	Tapered	00	12 ea	25.00/1.17
40565	24" Foam Block with Black Tampico, 3" trim	Tapered	00	12 ea	34.00/2.61
40561	18" Foam Block with Horsehair-Polypropylene Blend, 3" trim	Tapered	00	12 ea	25.00/2.14
40562	24" Foam Block with Horsehair-Polypropylene Blend, 3" trim	Tapered	00	12 ea	31.50/2.61
362208P18	18" Foam Block with Black Polypropylene, 3" trim	Tapered	03	12 ea	23.00/2.02
362208P24	24" Foam Block with Black Polypropylene, 3" trim	Tapered	03	12 ea	27.64/2.56

Heavy

- Recommended Use: Outdoors on rough surfaces such as sidewalks and parking lots
- For wet or dry sweeping
- Polypropylene (PPY) bristles are stiff and long lasting under harsh conditions. PPY bristles resist oil and water making them ideal for back-of-house cleaning
- Palmyra bristles are medium stiff and long lasting under harsh conditions
- Plastic blocks are extremely durable and resist water, cracking, splitting and chipping
- Wood blocks are made with natural lacquered hardwood

Plastic Block



36207218

Wood Block



45222
367624

40621
367618

Handles sold separately; see pages 276-279 for handle recommendations



Prod No	Description	Handle	Color	Pack	Cs Wt/Cube
Heavy Floor Sweeps					
36207218	18" PPY Sweep, Foam Block, 3.25" trim	Tapered	00	12 ea	21.60/2.01
36207224	24" PPY Sweep, Foam Block, 3.25" trim	Tapered	00	12 ea	35.52/2.63
40621	18" Palmyra Sweep with Hardwood Block, 3.5" trim	Threaded/Tapered	00	12 ea	24.00/2.14
45222	24" Palmyra Sweep with Hardwood Block, 3.5" trim	Threaded/Tapered	00	12 ea	43.00/3.63
367618	18" PPY Sweep, Hardwood Block, 3.25" trim	Threaded/Tapered	24	12 ea	20.00/2.27
367624	24" PPY Sweep, Hardwood Block, 3.25" trim	Threaded/Tapered	24	12 ea	29.26/2.46

DUSTPANS & SWEEPERS

Lobby Pan & Broom Combos

- Lobby pans and brooms with sectional handles to give you over 50% reduction in carton size; lower cube saves warehouse space and shipping costs
- The lobby pans pivot and lock into place during use and release for easy carrying or emptying
- Handles feature a pivoting hanging hole at top for storage

361415 Combo includes the following:

- Serrated edge allows you to comb the broom's bristles and drop debris into the pan
- Handy clip to attach broom for convenient storage
- 30" two-piece handle made from vinyl coated steel

361416 Combo includes the following:

- Adjustable position head for more functional use in corners and under counters or tables
- Handy clip to attach broom for convenient storage
- Shelf-friendly packaging



Black(03)

Prod No	Description	Material	Style	Color	Pack	Cs Wt/ Cube
Lobby Pan & Broom Combos						
361415	Duo-Pan™ Lobby Pan & Duo-Sweep Broom Combo	Plastic	Lobby	03	1 ea	3.75/0.46
361412	Broom Handle Clip for 361415	—	—	03	12 ea	5.04/0.16
361416	Duo-Pan™ II Lobby Pan & Broom Combo	Plastic	Lobby	03	4 ea	12.00/1.56

Dust & Lobby Pans

- Dust Pans are available in metal or plastic as well as in a “flip-up” lobby style or hand held
- Dust pan (361437) features a 90° threaded handle hole to convert it to an economy lobby dustpan
- 361420 features a 2 piece handle which reduces the carton size saving warehouse space and shipping costs

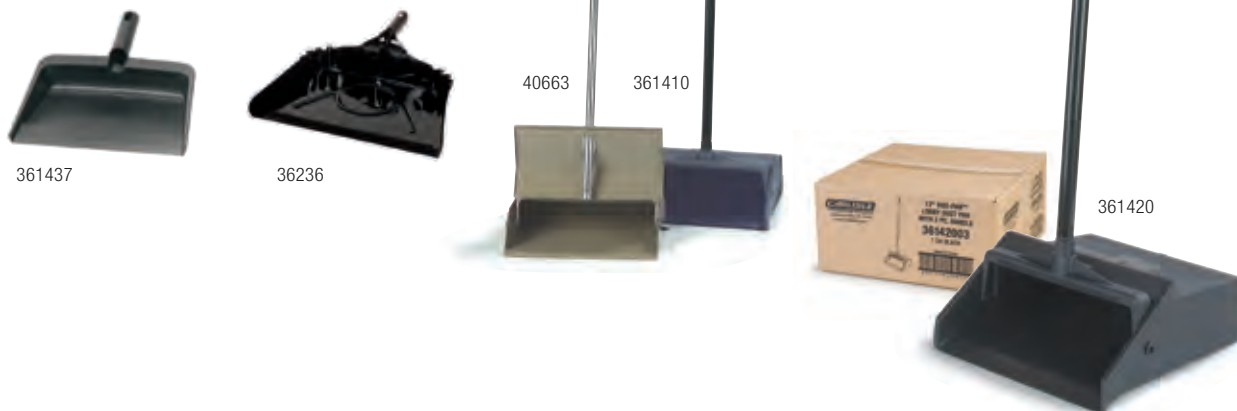

Floor Sweepers

- Brushless mechanical sweeper has non-marking rubber blades that grab fine particles and heavy debris from various types of floor surfaces
- Large capacity dust bins thoroughly clean blades as they rotate; won't re-deposit dirt like ordinary sweepers
- Easy one touch doors for emptying debris
- Shelf-friendly packaging



Prod No	Description	Material	Style	Color	Pack	Cs Wt/ Cube
Dust & Lobby Pans						
36142003	Lobby Dust Pan with 2-Piece Handle	—	Lobby	03	1 ea	2.53/0.47
361437	12" Wide Rubberized Plastic Dustpan	Plastic	Hand-Held	03	24 ea	12.96/3.13
36236	12" Metal Dustpan	Heavy Gauge Steel	Hand-Held	03	12 ea	14.04/2.08
361410	12" Duo-Pan™ Plastic Lobby Pan with Metal Handle	Plastic	Lobby	03	6 ea	14.50/2.05
36141003-1	12" Duo-Pan™ Plastic Lobby Pan with Metal Handle	Plastic	Lobby	—	1 ea	3.02/1.16
40663	12" Wide Steel Lobby Pan with Steel Handle	Steel Handle	Lobby	00	6 ea	26.00/4.29
Floor Sweepers						
36399	9.5" Multi-Surface Sweeper	—	—	14	4 ea	10.30/0.91
36400	12" Multi-Surface Sweeper	—	—	14	4 ea	12.0/1.56



FLOOR SCRUB BRUSHES

Dual Surface Brushes

- Recommended use: Cleaning kitchen floors, under counters, around equipment, and along baseboards
- Floor scrubs are made with three different brush surfaces for cleaning at different angles
- Non-absorbent plastic blocks and synthetic bristles wash easily and prevent gathering of mold and mildew



Scrub Brushes

- Recommended use: Cleaning kitchen floors, under counters, around equipment, and along baseboards
- Polypropylene (PPY) bristles are stiff and long lasting under harsh conditions. PPY bristles resist oil and water making them ideal for back-of-house cleaning
- Tampico bristles provide durability and high resistance to solvents and heat
- Palmyra bristles are medium stiff and long lasting under harsh conditions
- Natural wood block



Handles sold separately; see pages 276-279 for handle recommendations

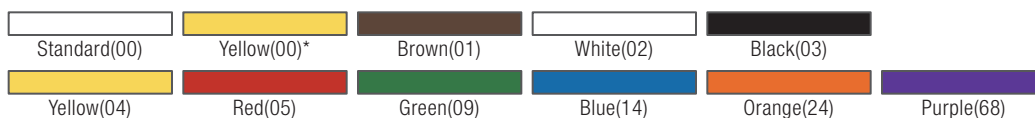

Prod No	Description	Handle	Color	Pack	Cs Wt/Cube
Dual Surface Brushes					
40423	10" Hi-Lo Floor Scrub Brush	Threaded	01, 02, 03, 04, 05, 09, 24, 68	12 ea	16.00/1.28
36197	10" Dual Surface Scrub Brush	Threaded	14	12 ea	14.14/1.95
36190	10" Dual Surface Scrub Brush with Squeegee	Threaded	14	12 ea	13.75/1.56
40422	10" Dual Surface Scrub Brush with End Bristles	Threaded	00*, 05, 09, 14	12 ea	16.45/1.34
Floor & Deck Scrub Brushes					
36175	10" Wood Block with Stiff Polypropylene Bristles	Threaded/Tapered	14	12 ea	11.50/0.75
36275	12" Wood Block with Stiff Polypropylene Bristles	Threaded/Tapered	14	12 ea	14.50/0.97
36193	10" Wood Block with Tampico Bristles	Threaded/Tapered	00	12 ea	11.75/0.82
36192	10" Wood Block with Palmyra Bristles	Threaded/Tapered	00	12 ea	12.00/0.87
36292	12" Wood Block with Palmyra Bristles	Threaded/Tapered	00	12 ea	15.00/0.97

Swivel Floor Brushes

- Patented* design swivels onto side to clean baseboards, walls, around kitchen equipment, and other hard to reach areas

*U.S. Patent No. 4763377



Tile & Grout Brushes

- 365320 has bevel cut stiff crimped nylon bristles and a swivel head for hard to reach areas
- 41323 features a molded in scraper for tough dirt and grime and can be hand held or used with a threaded handle. Base resins for block and bristles are FDA compliant



Handles sold separately; see pages 276-279 for handle recommendations

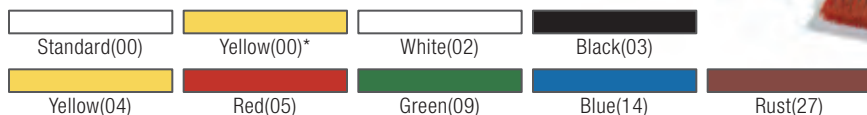

Prod No	Description	Handle	Color	Pack	Cs Wt/Cube
Swivel Floor Brushes					
365300*	8" Heavy-Duty Daily Swivel Scrub with Nylon Grit Bristles	Threaded	14	12 ea	9.50/0.68
365310*	8" Swivel Scrub with Heavy Nylon Grit Bristles	Threaded	27	12 ea	9.50/0.68
40430	9" All-Around Scrub Brush with Stiff Polypropylene Bristles	Threaded	00*	12 ea	13.00/1.83
36219663	8" Polypropylene-Fill Swivel Scrub with 48" Handle	—	00	4 ea	6.12/1.84
Tile & Grout Brushes					
365320	7.5" Swivel Head Grout Line Brush, Nylon Bristle	Threaded/Tapered	03	12 ea	3.60/0.33
365351	8.5" Grout Brush, Nylon Bristle	—	03	24 ea	2.00/0.26
41323	9" Tile & Grout Brush	Threaded	02, 04, 05, 09, 14	12 ea	7.50/0.44



FLOOR SQUEEGEES

Double Foam Squeegees with Metal Frame

- Rugged black neoprene for heavy-duty removal of dirt, water and debris on uneven surfaces
- Medium flexibility and non-marking

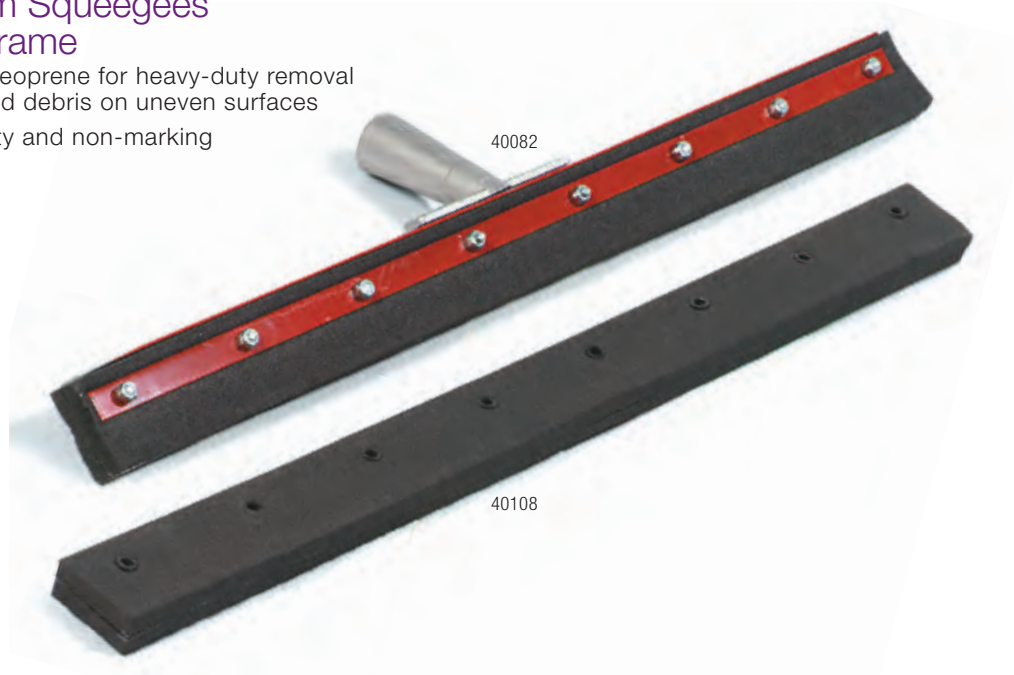

Double Moss Foam Rubber with Metal Frame

- Moss Foam squeegee is designed for uneven, grouted and smooth surface floors
- Red Moss Foam is fat and oil resistant

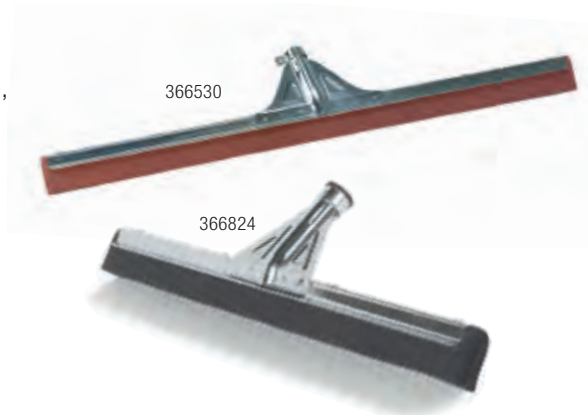

Handles sold separately; see pages 276-279 for handle recommendations

Standard(00)

Prod No	Description	Handle	Color	Pack	Cs Wt/Cube
Double Foam Squeegees with Metal Frame					
40081	18" Double Foam Neoprene Rubber	1.13" Tapered	00	6 ea	9.20/0.77
40082	24" Double Foam Neoprene Rubber	1.13" Tapered	00	6 ea	14.00/1.00
40083	30" Double Foam Neoprene Rubber	1.13" Tapered	00	6 ea	14.20/1.25
40107	18" Double Foam Neoprene Rubber Refill	—	00	12 ea	1.55/0.20
40108	24" Double Foam Neoprene Rubber Refill	—	00	12 ea	2.01/0.20
40109	30" Double Foam Neoprene Rubber Refill	—	00	12 ea	3.00/0.32
Double Moss Foam Rubber with Metal Frame					
366318	18" Soft Black Foam Rubber	.94" Tapered	00	10 ea	5.80/0.54
366324	22" Soft Black Foam Rubber	.94" Tapered	00	10 ea	8.30/1.03
366824	22" Soft Black Heavy-Duty Foam Rubber	Threaded	00	10 ea	12.00/1.03
366330	30" Reinforced Soft Black Foam Rubber	.94" Tapered	00	10 ea	16.00/1.58
366530	30" Reinforced Red Foam Rubber	.94" Tapered	00	10 ea	16.00/1.58

Double Foam Rubber Squeegee with Plastic Frame

- All plastic construction will not rust or bend and helps prevent hazard sparks when cleaning-up flammable fluids
- Available in colors to support HACCP compliance
- For uneven or smooth surfaces

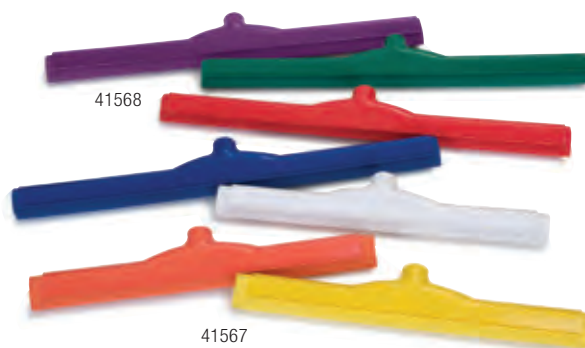

Double Moss Foam Rubber Squeegee with Plastic Frame

- Soft, double foam is fat and oil resistant
- All plastic construction will not rust or bend and helps prevent hazard sparks when cleaning-up flammable fluids
- For uneven or smooth surfaces



Double Foam Rubber Squeegee & Brush with Plastic Frame

- Use the brush side to remove stubborn debris and the squeegee side to dry the floor
- All plastic construction will not rust or bend and helps prevent hazard sparks when cleaning-up flammable fluids

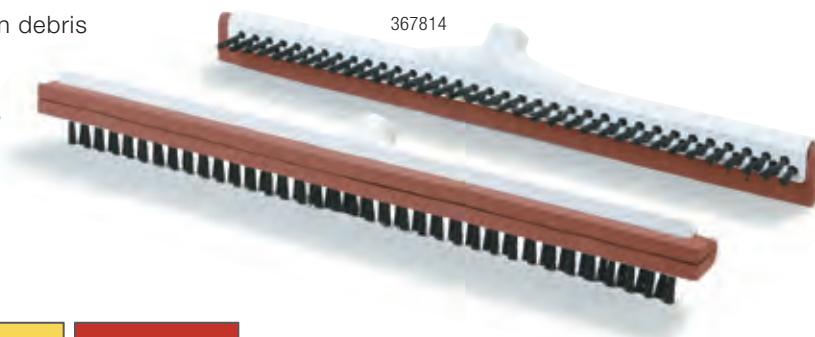

Handles sold separately; see pages 276-279 for handle recommendations

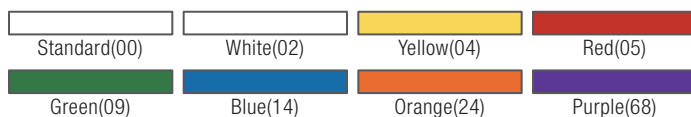

Prod No	Description	Handle	Color	Pack	Cs Wt/Cube
Double Foam Rubber Squeegee with Plastic Frame					
41567	18" Double Foam Rubber Floor Squeegee	Threaded	02, 04, 05, 09, 14, 24, 68	6 ea	4.40/0.67
41568	24" Double Foam Rubber Floor Squeegee	Threaded	02, 04, 05, 09, 14, 24, 68	6 ea	5.27/0.87
Double Moss Foam Rubber Squeegee with Plastic Frame					
366918	18" Red Foam Rubber	.94" Threaded	00	10 ea	7.50/1.34
366922	22" Red Foam Rubber	.94" Threaded	00	10 ea	10.60/1.97
Double Foam Rubber/Brush with Plastic Frame					
367814	14" Red Double Foam Red Rubber	Threaded	00	10 ea	6.30/1.05
367818	18" Red Double Foam Red Rubber	Threaded	00	10 ea	6.30/1.05



FLOOR SQUEEGEES

Curved End Rubber Squeegee with Metal Frame

- Single rubber blade design
- Curved end controls liquid better
- For smooth surfaces
- Red gum rubber is non-marking and durable for heavy-duty use



One-Piece Rubber Squeegee with Plastic Frame

- All plastic construction will not rust or bend and helps prevent hazard sparks when cleaning-up flammable fluids
- Available in colors to support HACCP compliance
- For smooth surfaces



Handles sold separately; see pages 276-279 for handle recommendations

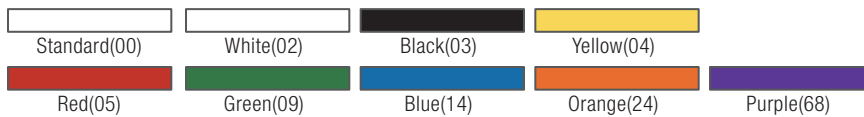

Prod No	Description	Handle	Color	Pack	Cs Wt/Cube
Single Curved End Rubber Squeegee with Metal Frame					
36324C	24" Curved End Black Rubber Squeegee	1.13" Tapered	00	6 ea	15.00/0.35
36336C	36" Curved End Black Rubber Squeegee	1.13" Tapered	00	6 ea	22.00/0.37
40078	24" Curved End Red Gum Rubber Squeegee	1.13" Tapered	00	6 ea	15.00/1.00
One-Piece Rubber Squeegee with Plastic Frame					
36567	20" Solid, One-Piece Rubber Squeegee	Threaded	02, 03, 04, 05, 09, 14, 24, 68	6 ea	5.50/0.51
36568	24" Solid, One-Piece Rubber Squeegee	Threaded	02, 03, 04, 05, 09, 14, 24, 68	6 ea	6.50/0.61

Straight Rubber Squeegee with Metal Frame

- Durable construction
- Non-marking single red gum rubber blade with medium flexibility
- Heavy duty steel frame with red powder coating



VersaClean™ Brush & Squeegee

- It's a broom, scrub brush and squeegee all in one! Can be used on wet or dry surfaces
- Unique non-marking synthetic rubber bristles can build electrostatic charge to pick up hair or other light debris from soft or hard floor surfaces
- Durable bristles are excellent for scrubbing
- Dishwasher safe making it one of the most hygienic broom and brush options on the market
- Resists most chemicals and withstands temperatures up to 212°F

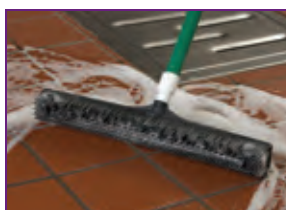

Squeegee cleans up wet surfaces quickly



Picks up light debris from carpet, rugs, or bare floors



Use as an agitator for stubborn spots on tile or concrete



Built-in one-piece squeegee works on rough concrete surface

Handles sold separately; see pages 276-279 for handle recommendations

Standard(00)

Prod No	Description	Handle	Color	Pack	Cs Wt/Cube
Single Straight Rubber Squeegee with Metal Frame					
40075	18" Straight Red Gum Squeegee	1.13" Tapered	00	6 ea	10.95/0.77
40076	24" Straight Red Gum Squeegee	1.13" Tapered	00	6 ea	14.15/0.99
40077	36" Straight Red Gum Squeegee	1.13" Tapered	00	6 ea	23.00/1.46
VersaClean Brush & Squeegee					
36592	VersaClean Brush with Squeegee	Threaded	03	12 ea	11.00/1.08
36596	VersaClean Brush with Squeegee	Threaded	03	12 ea	14.00/1.42



HANDLES

Carlisle offers a large selection of professional quality handles that include fiberglass, plastic, metal, hardwood, and telescoping.

Color-Coded Fiberglass Handles

- Durable for heavy usage
- For use with push brooms, sweeps, squeegees, and floor scrubs
- Fiberglass handles are available in threaded, tapered/threaded and telescoping
- Self-Locking Flex-Tip Handle offers greater flexibility and reduces handle stress

Plastic Handles

- A variety of sizes with reinforced threaded tip
- For light usage



Prod No	Description	Dia	Style	Color	Pack	Cs Wt/Cube
Color-Coded Fiberglass Handles						
41225	48" Fiberglass Handle with Self-Locking Flex-Tip	1"	Threaded	00*, 04, 05, 09, 14	12 ea	10.50/0.64
40225	60" Fiberglass Handle with Self-Locking Flex-Tip	1"	Threaded	01, 02, 03, 04, 05, 09, 14, 24, 25, 68	12 ea	13.00/0.80
40227	60" Solid Foam Filled Fiberglass Handle with Self-Locking Flex-Tip	1"	Tapered/Threaded	02, 04, 05, 09, 14	12 ea	16.00/0.80
40220	60" Fiberglass Handle	1"	Tapered/Threaded	01, 02, 04, 05, 09, 14	12 ea	12.00/2.14
40210	60" Economy Fiberglass Handle	.94"	Female Threaded	01, 02, 04, 05, 09, 14	12 ea	10.26/0.89
41020	54" to 8' Threaded Telescoping Fiberglass Handle	1"	Threaded Telescoping	01, 02, 04, 05, 09, 14	12 ea	28.00/1.00
Plastic Handles						
40230	36" Plastic Handle with Reinforced Tip	1"	Threaded	00*	12 ea	17.70/0.55
40233	48" Plastic Handle with Reinforced Tip	1"	Threaded	00*	12 ea	22.00/0.76
40232	60" Plastic Handle with Reinforced Tip	1"	Threaded	00*	12 ea	27.00/0.91

FIBERGLASS

PLASTIC

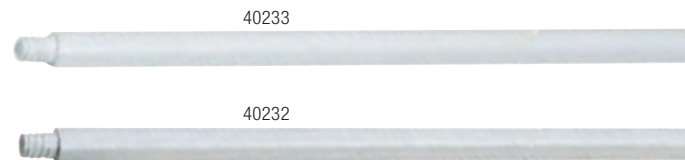



METAL

Coated Metal Handles

- Lightweight and economical
- Plastic hanging cap

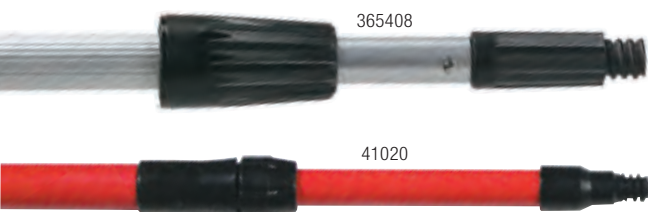

TELESCOPIC

Telescopic Handles

- Adjusts quickly to desired length
- Standard threaded end
- Ideal for window brushes and squeegees

3-Piece Aluminum Handle

- Utilizes metal y-connectors to secure sections
- Compact size saves on shipping costs
- Shelf-ready packaging

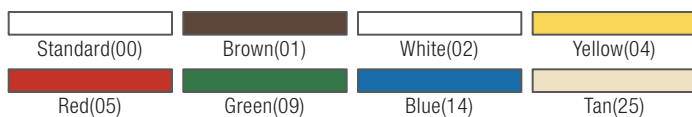

Prod No	Description	Dia	Style	Color	Pack	Cs Wt/Cube
Coated Metal Handles						
3620194	48" Light Weight Powder Coated Metal Handle with Plastic Tip	.88"	Threaded	14	12 ea	7.85/0.71
3620294	48" Plastic Coated Metal Handle	.94"	Threaded	03	12 ea	8.00/0.46
Telescopic Handles						
365408	54" to 8' Aluminum Telescopic Handle with Locking Joints	1"	European Tapered/Standard Threaded	00	10 ea	11.90/0.48
41020	54" to 8' Fiberglass Telescopic Handle	1"	Threaded	01, 02, 04, 05, 09, 14, 25	12 ea	28.00/1.00
3-Piece Aluminum Handle						
40224	60" 3-Piece Aluminum Handle with Standard Thread	1"	Threaded	00	12 ea	13.00/0.80

HANDLES & ACCESSORIES

Wood Handles

- Made of lacquered hardwood
- Available in a large selection of standard threaded and tapered styles, along with our Anchor™ Style
- Economical choice

WOOD



Dust Mop Handles

- Available in wood, coated metal and fiberglass
- 360° movement for fast and easy cleaning
- 364105 features a flexible connector

DUST MOP

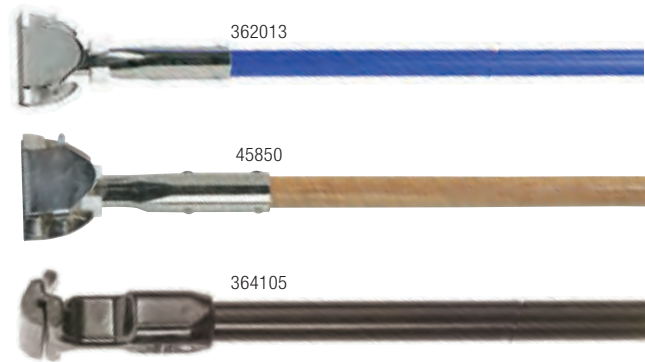

Standard(00)	White(02)	Black(03)
Yellow(04)	Red(05)	Green(09)
Blue(14)	Orange(24)	Purple(68)

Prod No	Description	Dia	Style	Color	Pack	Cs Wt/Cube
Wood Threaded Handles						
40271	60" Wood Handle	.94"	Threaded	00	12 ea	13.36/0.49
40267	60" Wood Handle	1.13"	Threaded	00	12 ea	16.00/0.62
Metal Threaded Handles						
40275	40" Metal Tip Wood Handle	.88"	Metal Thread	00	12 ea	9.65/0.40
45267	60" Wood Handle with Metal Tip	.94"	Metal Thread	00	12 ea	13.75/0.49
Tapered Handles						
40261	54" Wood Handle	1.13"	Tapered	00	12 ea	15.00/0.59
40262	60" Wood Handle	1.13"	Tapered	00	12 ea	16.80/0.66
Dust Mop Handles						
364105	60" Vinyl Coated Metal Dust Mop Handle with Flexible Connector	.94"	—	00	12 ea	15.00/2.10
45850	60" Wood Dust Mop Handle with Clip-On Connector	.94"	—	00	12 ea	20.00/1.63
362013	60" Vinyl Coated Metal Dust Mop Handle with Clip-On Connector	.94"	—	00	12 ea	20.10/2.54
Fiberglass Dust Mop Handles						
362113	60" Fiberglass Dust Mop Handle	1"	—	02, 03, 04, 05, 09, 14, 24, 68	12 ea	25.00/3.46

Roll 'N Grip™ Broom & Brush Holder System

- Adjustable rack holds a variety of different handle diameters
- Comes with a convenient hook for tools and brushes (additional hooks and grippers are available by special order)
- Rack anchor holes are 16" on center (mounting screws included)

40731



Roll 'N Grip Plus

- Constructed of light-weight, durable ABS and rubber
- Fold-up hanging hooks for smaller items
- For use in temperatures from -4°F to 176°F
- Grips accommodate items from 5/8" - 1-1/4" in diameter and 0.4 - 8.25 lbs
- Hanging hooks can hold up to 1.5 lbs each

40737



Color-Coded Brush Rack

- Heavy-gauge aluminum
- Extra deep (2-1/4") frame extends out from wall to allow brushes to hang with bristles facing the wall
- Holds up to 10 hanging tools
- Mounting holes are 16" on center (mounting screws included)
- Available in 5 colors to support HACCP compliance

40735



Prod No	Description	Color	Pack	Cs Wt/ Cube
Roll 'N Grip Broom & Brush Holder System				
40731	18" Roll 'N Grip Broom & Brush Holder System	00	12 ea	9.00/1.06
40732	Roll 'N Grip Replacement Roller (2 per pack) with 4 Wood Screws	00	12 pk	3.35/0.30
40733	Roll 'N Grip Replacement Hooks (2 per pack) with 4 Wood Screws	00	12 pk	0.50/0.16
Roll 'N Grip Plus				
40737	16-1/2" Roll 'N Grip Plus Broom & Brush Holder	00	24 ea	35.00/2.68
Color-Coded Brush Rack				
40735	17" Brush Rack	00*, 04, 05, 09, 14	12 ea	3.50/0.77



MICROFIBER SYSTEM & DUST MOPS

Microfiber Dry Mop

- Looped end with microfiber center clings to dust like a magnet
- Quickly attaches itself to aluminum head
- Machine washable



3633118

Microfiber Wet Mop

- Dries quicker, cleans more thoroughly than a standard mop
- Machine washable and still effective with over 500 washings
- Quickly attaches itself to aluminum head



3633218

3633519

Aluminum Flat Mop Heads & Telescoping Handle For Microfiber

Mop Heads

- Heavy duty construction and swivel mechanism
- For use with wet and dry microfiber flat mops

Handle

- 70" telescopic handle for use with Aluminum flat mop heads



3633670

3633519

Handles sold separately; see pages 276-279 for handle recommendations



Prod No	Description	Handle	Color	Pack	Cs Wt/Cube
Microfiber Dry Mops					
3633118	18" Microfiber Dry Mop Pad	—	14	12 ea	3.10/0.41
3633124	24" Microfiber Dry Mop Pad	—	14	12 ea	4.25/0.80
3633136	36" Microfiber Dry Mop Pad	—	14	12 ea	6.55/0.90
Microfiber Wet Mops					
3633218	18" Microfiber Wet Mop Pad	—	05, 09, 14	12 ea	2.10/0.21
3633224	24" Microfiber Wet Mop Pad	—	14	12 ea	2.80/0.33
Aluminum Flat Mop Heads					
3633519	18" Aluminum Flat Mop Head	3633670	00	12 ea	8.60/0.98
3633525	24" Aluminum Flat Mop Head	3633670	00	12 ea	10.90/1.25
3633537	36" Aluminum Flat Mop Head	3633670	00	12 ea	13.30/1.92
Telescoping Handle					
3633670	70" Aluminum Telescopic Handle	—	00	12 ea	3.70/1.20

Microfiber Charging Bucket

- Rectangular bucket with 6 gallon capacity
- Includes snap-on lid and clip-on plastic sleeve for window washers and squeegees
- Molded-in graduations
- Ergonomic handle for easy transportation



3633019

Tie Back Dust Mops & Frames

- An economical choice for a cotton dust mop with full tie back
- Frame is constructed of heavy gauge metal
- Zinc plating reduces rust and corrosion



3647524

41672

Wedge Dust Mop

- Cotton dust mop with frame
- Threaded handle hole
- For hard-to-reach areas



36490

Handles sold separately; see pages 276-279 for handle recommendations



Prod No	Description	Handle	Color	Pack	Cs Wt/Cube
Rectangular Microfiber Bucket					
3633019	6 gal Rectangular Microfiber Bucket	—	23	3 ea	12.50/1.15
Value Line Tie Back Dust Mops					
3647524	24" Dust Mop, Fits 5" Wide Frame	—	00	12 ea	15.96/1.08
3647536	36" Dust Mop, Fits 5" Wide Frame	—	00	12 ea	18.96/1.42
3647548	48" Dust Mop, Fits 5" Wide Frame	—	00	12 ea	24.96/1.83
Wedge Dust Mop					
36490	Wedge Dust Mop	Threaded	00	12 ea	7.20/1.07
36490R	Wedge Mop Replacement	Threaded	00	12 ea	5.04/1.07
Dust Mop Frames					
41672	24" Mop Frame, 5" Wide	Clip-On/Flexible	00	12 ea	12.75/0.42
41673	36" Mop Frame, 5" Wide	Clip-On/Flexible	00	12 ea	17.00/0.62
3647248	48" Mop Frame, 5" Wide	Clip-On/Flexible	00	12 ea	24.00/1.01



WET MOPPING GUIDE

Use the guide below to help choose the right products for your floor care needs.

General Mopping

Choose mops with high absorbency, release and durability. If laundering facilities are available, it is beneficial to take advantage of launderable mops to save money. For performance and durability choose a synthetic blend or rayon mop with looped end and woven tailbands.

Yarn

- It is important to choose the right mop in order to get maximum efficiency
- Some yarns naturally perform specific cleaning tasks better than others

Yarn Ply

- Yarn ply is the number of strands twisted together to make a single yarn strand
- Although more plies give added strength, it does not always mean higher quality yarn
- More strands can add durability, but they decrease absorbency
- It is better & more cost effective to choose a higher quality yarn than a high ply, low quality yarn

Twist

- The “twist” of a yarn is a result of how tightly the fiber strands are wound together
- A tightly twisted yarn might have more strength & last longer, but it can have less absorbency
- The best choice is determined by the type & quality of the yarn, as well as the mop’s construction
- Mops with looped-end construction allow the yarn to have a loose twist without the fraying

Finish Mopping

For finish mopping applications look for a rayon or synthetic mop. These mops offer high absorbency and release. To make sure you are achieving maximum floor coverage with minimal streaking choose a tailband and looped end yarn.

	Advantages	Disadvantages	Use
Cotton	Good absorption & retention with limited shrinkage & a low initial cost.	Break-in period required. Slow drying yarn leads to mildew & deterioration. Lints.	Designed for general use. Scrubbing & cleaning up liquids.
Synthetic	Long stable fiber offers excellent tensile strength without linting.	Higher cost. Poor absorption.	Rough surfaces.
Cotton Synthetic Blend	Excellent choice for performance, price & durability. Synthetic fiber offers durability & color options.	Possible shrinkage.	Requested by professionals who require a better, longer lasting mop.
Rayon	Absorbs quickly with easy release. Dries fast & is mildew resistant. Cleaner yarn with less linting.	Shrinks when laundered and has less liquid retention.	Use for applying liquids such as disinfectant or floor finishes.



Band Styles



Wide Band
Vinyl coated mesh. 5" Width



Narrow Band
Textured polyester tape. 1.25" Width



Screw Top
Textured polyester tape with a metal screw on attachment. 1.25" Width

Handle — Jaw Style



Handle — Quick Change/Release



Handle — Screw In



Cut-End Or Looped-End

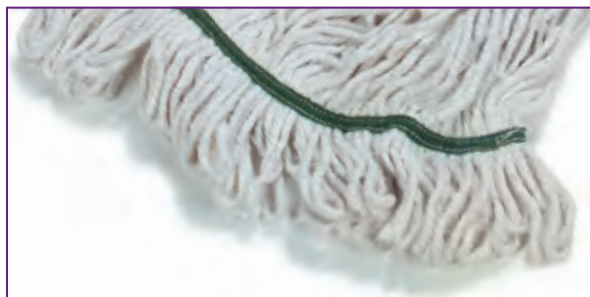

Cut-End

- Cut-end mops are the most popular
- Low purchase price compared to looped end
- Cannot be laundered
- Cover less area per pass when mopping

Looped-End

- Superior performance & lasts longer than cut-end mops
- Launderable
- Tailband style gives better mopping coverage
- Looped-ends prevent fraying & unraveling so you can achieve reduced labor costs & replace mops less often
- Although the initial investment is more than a cut-end style, the life expectancy makes looped-end mops a more economical choice

How We Rate Our Mops

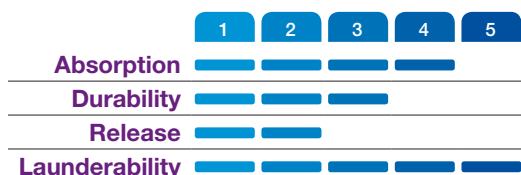

Absorbency

The absorbency of a mop refers to the ability to pick up and retain liquid. Higher levels allow faster floor drying times, leading to greater productivity and safety. Rayon and cotton yarns have the highest absorbency.

Durability

Mop durability is a measure of how long it will last or perform before needing replacement. Synthetic and blended mops are the most durable.

Release/Retention

Release is the ability of a mop to disperse liquid onto the floor or during wringing. Higher levels allow faster and more complete wringing, as well as more efficient application of cleaning solutions on the floor.

Launderability

The launderability is based on the number of washing cycles it can withstand before the construction of the mop is degraded. Synthetic and blended fiber mops have the highest levels of launderability.

Sizes Are Indicated By Tailband Color

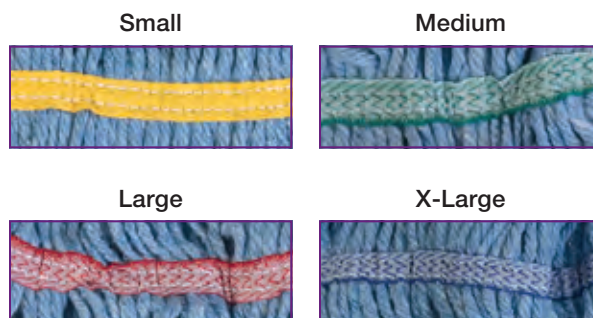

Brick Packs

Mops that are available in brick packs reduce cube up to 62%

(Item #'s ending with a "B" are sold in brick packs)



LOOPED END MOPS

Synthetic/Cotton Blend Looped-End

- Maximum Durability
- 50-75 uses per mop
- S, M, and L are available in brick packs

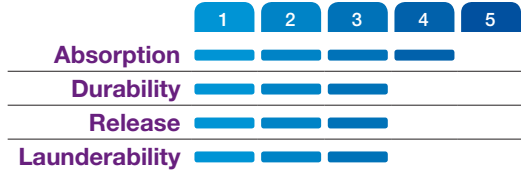

4 Ply Cotton Looped-End

- All purpose for general cleaning
- Packaged in brick packs

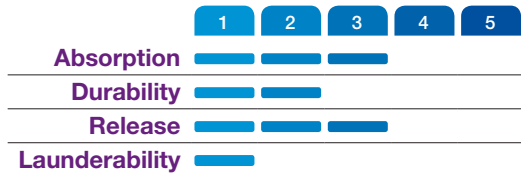

Handles sold separately; see pages 288-289 for handle recommendations



Prod No	Description	Handle	Color	Pack	Cs Wt/Cube
Synthetic/Cotton Blend (Wide Band)					
369412B	Small Yellow Wide Band Mop with White Yarn	Jaw Style	00	12 ea	8.00/0.68
369442B	Small Yellow Wide Band Mop with Blue Yarn	Jaw Style	14	12 ea	8.00/0.68
369472B	Small Yellow Wide Band Mop with Green Yarn	Jaw Style	09	12 ea	8.00/0.68
369418B	Medium Green Wide Band Mop with White Yarn	Jaw Style	00	12 ea	12.5/0.68
369448B	Medium Green Wide Band Mop with Blue Yarn	Jaw Style	14	12 ea	12.50/0.68
369478B	Medium Green Wide Band Mop with Green Yarn	Jaw Style	09	12 ea	12.50/0.74
369424B	Large Red Wide Band Mop with White Yarn	Jaw Style	00	12 ea	17.20/0.74
369454B	Large Red Wide Band Mop with Blue Yarn	Jaw Style	14	12 ea	17.20/0.74
369484B	Large Red Wide Band Mop with Green Yarn	Jaw Style	09	12 ea	17.20/0.74
369430	X-Large Blue Wide Band Mop with White Yarn	Jaw Style	00	12 ea	23.04/2.71
369460	X-Large Blue Wide Band Mop with Blue Yarn	Jaw Style	14	12 ea	23.04/2.92
4-Ply Cotton (Wide Band)					
369550B	Small Yellow Band Looped-End Mop	Jaw Style	00*	12 ea	8.00/0.68
369551B	Medium Green Band Looped-End Mop	Jaw Style	00*	12 ea	12.50/0.68
369552B	Large Red Band Looped-End Mop	Jaw Style	00*	12 ea	17.20/0.74
4 Ply Cotton (Narrow Band)					
369413B	Small Yellow Band Looped-End Mop	Quick Release/Quick Change	00*	12 ea	8.10/0.68
369419B	Medium Green Band Looped-End Mop	Quick Release/Quick Change	00*	12 ea	12.60/0.68
369425B	Large Red Band Looped-End Mop	Quick Release/Quick Change	00*	12 ea	17.80/0.74

Microfiber Looped-End

- Microfiber mop combines the absorbency and durability of microfiber with conventional mop design and functionality
- Washable mop dries quickly and is still effective with 500 washings
- See pages 280-281 for a complete list of microfiber products

	1	2	3	4	5
Absorption	█	█	█	█	█
Durability	█	█	█	█	█
Release	█	█	█	█	█
Launderability	█	█	█	█	█



Rough Surface Looped-End

- 17 oz knitted fleece provides twice the absorbency of cotton yarn mops
- Excellent for abrasive surfaces: stone, quarry, tile, and concrete

	1	2	3	4	5
Absorption	█	█	█	█	█
Durability	█	█	█	█	█
Release	█	█	█	█	█
Launderability	█	█	█	█	█



Handles sold separately; see pages 288-289 for handle recommendations

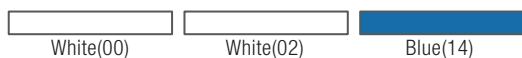

Prod No	Description	Handle	Color	Pack	Cs Wt/Cube
Microfiber (Wide Band)					
369420	Medium Loop End Microfiber Mop	Jaw Style	02, 14	12 ea	14.00/1.33
Rough Surface (Narrow Band)					
369320	Medium Looped-End Rough Surface Mop	Quick Release/Quick Change	00	12 ea	11.04/1.06



LOOPED END & CUT END MOPS

Rayon Blend Finishing Looped-End

- Durable 4-ply rayon blend has narrow band
- Releases liquid faster than a conventional mop for a smoother finish
- Brick packed



369674B

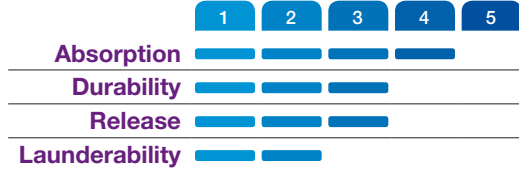

4 Ply Cotton Cut-End

- Economical choice for general mopping
- Brick packed



369817B

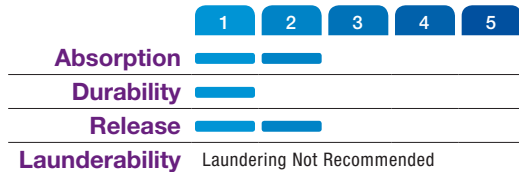

369824B

Handles sold separately; see pages 288-289 for handle recommendations



Prod No	Description	Handle	Color	Pack	Cs Wt/Cube
4 Ply Rayon Blend Finishing (Wide Band)					
369670B	#20 Medium Finishing Looped-End Mop	Quick Release/Quick Change	14	12 ea	14.00/0.68
369674B	#24 Large Finishing Looped-End Mop	Quick Release/Quick Change	14	12 ea	17.20/0.74
4 Ply Cotton (Narrow Band)					
369816B	#16 Small Cut-End Mop	Quick Release/Quick Change	00	12 ea	10.25/0.68
369820B	#20 Medium Cut-End Mop	Quick Release/Quick Change	00	12 ea	13.25/0.68
369824B	#24 Large Cut-End Mop	Quick Release/Quick Change	00	12 ea	16.25/0.68
369832	#32 X-Large Cut-End Mop	Quick Release/Quick Change	00	12 ea	20.52/1.66
4 Ply Cotton (Wide Band)					
369811B	#16 Small Cut-End Mop	Jaw Style	00	12 ea	9.50/0.68
369814B	#20 Medium Cut-End Mop	Jaw Style	00	12 ea	10.25/0.68
369817B	#24 Large Cut-End Mop	Jaw Style	00	12 ea	14.00/0.68
369819B	#32 X-Large Cut-End Mop	Jaw Style	00	12 ea	15.50/0.68



8 Ply Cotton Cut-End

- Abrasion-resistant, long lasting 8 ply cotton
- Best for general purpose cleaning



369724

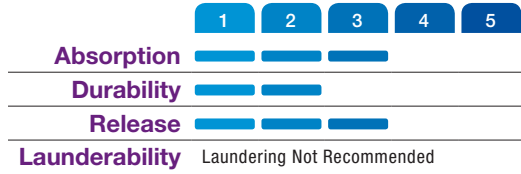

Kwik-On™ Screw Top

- Easy to change mop heads lie flat for more efficient mopping
- 40345 Kwik-On wood handle (sold separately) attaches securely to Kwik-On mop head with a counter-sunk, reinforced thread

40345

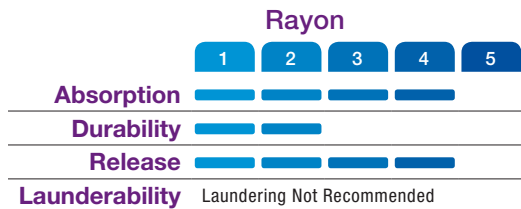
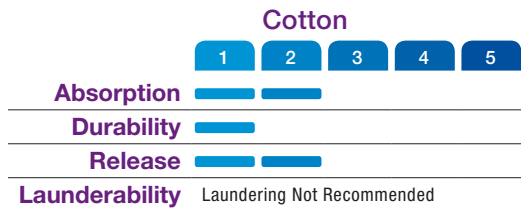

369024R



Handles sold separately; see pages 288-289 for handle recommendations

Standard(00)

Prod No	Description	Handle	Color	Pack	Cs Wt/Cube
8-Ply Cotton (Narrow Band)					
369724	#24 Select Cut-End Mop	Quick Release/Quick Change	00	12 ea	18.96/1.81
369732	#32 Select Cut-End Mop	Quick Release/Quick Change	00	12 ea	26.04/1.96
4-Ply Cotton (Kwik-On Screw Top)					
369024C	#24 Kwik-On Cotton Mop	Kwik-On	00	12 ea	18.96/1.50
4-Ply Rayon (Kwik-On Screw Top)					
369024R	#24 Kwik-On Rayon Mop Head	Kwik-On	00	12 ea	18.96/1.26
Kwik-On Handle					
40345	60" Kwik-On Handle 1.13" Diameter	—	00	12 ea	16.70/0.54



MOP HANDLES & ACCESSORIES

Automatic Sponge Mop

- Recommended for mopping smooth surfaces
- Synthetic sponge head absorbs liquid fast

Ty-Dee™ Sponge Mop

- Recommended for mopping smooth surfaces
- Cellulose sponge head with non-corrosive metal parts and enameled wood handle



Jaw Style Mop Handles

- Use with wide band mops

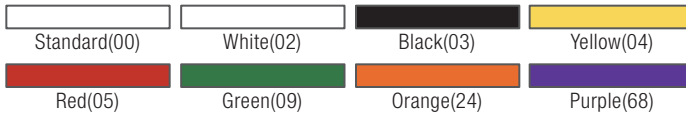

Prod No	Description	Dia	Color	Pack	Cs Wt/Cube
Automatic Sponge Mops – Aluminum Handle					
40300	8.5" Automatic Sponge Mop	—	00	12 ea	23.80/5.78
40301	12" Automatic Sponge Mop	—	00	6 ea	13.85/7.23
40305	8.5" Automatic Sponge Mop Refill	—	00	12 ea	3.85/0.44
40306	12" Automatic Sponge Mop Refill	—	00	6 ea	2.75/2.21
Ty-Dee Sponge Mop – Enamel Wood Handle					
36990	8.25" Ty-Dee Sponge Mop with Built-in Wringer	—	00	12 ea	18.96/4.04
36990R	8.25" Ty-Dee Refill	—	00	12 ea	3.96/0.35
Jaw Style Mop Handles					
369475	60" Fiberglass Mop Handle	1"	00, 02, 03, 04, 05, 09, 24, 68	12 ea	25.00/3.46
36970	60" Vinyl Coated Metal Mop Handle	.94"	00	12 ea	13.92/2.27

Quick-Release Mop Handles

- 60" durable fiberglass
- Flexible plastic head with hinged gripper bites into any size mop band
- Releases mop head quickly; employees never need to touch a dirty mop head



Quick Change Handles

- Use with narrow band mops
- Plastic head with thumb wheel clamps mop in place
- Metal heads feature standard wing nut construction with a quick release cross bar

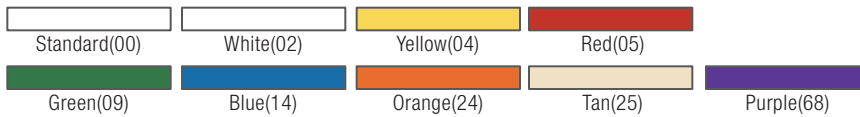

Prod No	Description	Dia	Color	Pack	Cs Wt/Cube
Color-Coded Quik-Release Mop Handle					
41664	60" Fiberglass Mop Handle	1"	02, 04, 05, 09, 14, 24, 25, 68	12 ea	15.75/2.78
Quik-Release Handle					
369595	Quik-Release Powder-Coated Metal Handle	—	00	12 ea	17.60/2.68
Quick Change Handles – Wood					
369365	60" Wood Mop Handle with Plastic Head	1.13"	00	12 ea	22.50/3.46
40340	63" Wood Mop Handle with Metal Head	1.13"	00	12 ea	30.00/2.00
Quick Change Handle – Fiberglass					
369375	60" Fiberglass Mop Handle with Plastic Head	1"	00	12 ea	16.25/3.46
Quick Change Handle – Vinyl Coated Metal					
36968	60" Handle with Plastic Head	1"	00	12 ea	15.36/2.27



MOP BUCKETS & SIGNS

Bucket & Wringer Combos

- Made of durable, corrosion resistant polyethylene
- Non-marking casters
- Available in 26 or 35 quart sizes
- Individual Side Press Wringer available
 - fits both 26 quart (36908) and 35 quart (36904) mop buckets



36905



36908W



36908



36904

36904

36904

36904



Prod No	Description	Color	Pack	Cs Wt/Cube
Mop Buckets				
36908	26 qt Bucket with Side Press Wringer	04, 05, 09, 14, 69	1 ea	15.40/3.01
36904	35 qt Bucket with Side Press Wringer	04, 05, 09, 14, 69	1 ea	19.10/3.15
36908W	Side Press Wringer for 26 qt and 35 qt Mop Bucket	04, 05, 09, 14, 69	1 ea	8.00/1.62
36905	35 qt Bucket with Down Press Wringer	04	1 ea	22.20/3.32
36908C	3" Swivel Casters for all Mop Buckets	00	2 ea	8.00/2.88

Wet Floor Signs

- Durable polypropylene
- Specially designed feet minimize contact with floor to protect floor finishes
- 36900 locks into place to prevent collapsing
- Compact for easy storage



Freestanding Caution Cones and Accessories

- 360° visibility
- Caution message appears in English, Spanish and French



The Flashing Hazard Light (36949) and Caution Top Card (36947) can be inserted in Caution Cones (36940, 36941) for increased visibility.



Caution Pop Up Cones

- 360° visibility
- Caution message appears in English, Spanish and French
- Case can be mounted to wall for easy access



Case for 36942 Pop Up Caution Cone

Caution Barrier

- Two-sided barrier
- Caution message appears in English, Spanish and French



Prod No	Description	Color	Pack	Cs Wt/Cube
Folding Wet Floor Signs				
36900*	Floor Sign (English/Spanish)	00	6 ea	11.25/1.88
36909	Economy Wet Floor Sign (English/Spanish/German)	04	6 ea	12.60/1.45
Caution Cones & Barriers				
36940	27" Caution Cone	04	3 ea	22.00/3.70
36941	36" Caution Cone	04	3 ea	22.00/4.75
36942	20" Pop Up Caution Cone	04	12 ea	57.00/2.18
36949	Caution Cone Flashing Hazard	04	12 ea	7.37/1.30
36947	Caution Cone Top Card	04	12 ea	11.00/1.59
36944	Three Panel Caution Barrier	04	1 ea	9.47/2.53
36945	One Panel Caution Barrier Add On	04	1 ea	4.62/2.53



SPILLEATER

The Natural Absorbent

- Up to 58% faster than all other absorbents
- SpillEater is environmentally friendly
- Safe to use, leaves no slippery residue
- USDA certified biobased product
- Available in 2 lb carton, 2 lb carton 4-pack, 20 lb pail or 4 ft sock
- Wall Mount Spill Station Kit (46303) is perfect for restaurants and kitchens; includes a wall mount rack with two cartons of SpillEater, broom and dust pan
- Portable Spill Station Kit (46304) for quick clean ups; includes a rolling spill station, two cartons of SpillEater, dust pan and squeegee-broom



46303

46300





Easy to Use

Spill



Cover



Combine



Collect



46301



46304



46302



Standard(00)

Prod No	Description	Color	Pack	Cs Wt/Cube
SpillEater Absorbent				
46300	2 lb Carton	00	12 ea	24.00/1.11
46305	2 lb Carton (4 pack)	00	1 pk	8.25/0.37
46301	20 lb Pail	00	1 ea	20.00/1.09
46302	4 ft Sock	00	6 ea	11.00/2.60
46303	Wall Mount Spill Station Kit (includes Rack, 2 Cartons 46300, Broom & Dust Pan)	00	1 ea	8.50/1.17
46304	Portable Spill Station Kit (includes Rolling Station, 2 Cartons 46300, Dust Pan and Squeegee-Broom)	00	1 ea	5.50/2.26



FLOOR & RESTROOM MAINTENANCE

Floor Drain Brush

- Long lasting polypropylene bristles and plastic handles stand up to rugged use
- Drain Brush handles (sold separately) are prominently marked in English and Spanish for "floor drain use only" to prevent contact with food and serving utensils
- Available in a variety of sizes



40146

Drain Opener

- Convenient, sanitary way to remove floor drain covers
- Easy to use, simply insert into drain and twist to remove drain cover and drain basket
- One-piece construction with plastic handles for secure grip



40144

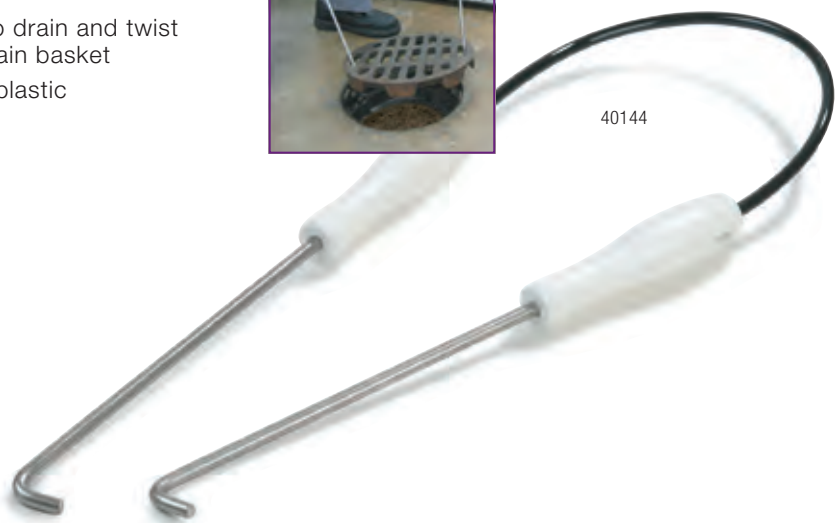

Standard(00)	White(02)
--------------	-----------

Prod No	Description	Color	Pack	Cs Wt/Cube
Drain Opener				
40144	Drain Opener	02	12 ea	6.50/0.78
Floor Drain Brush				
40146	3" Floor Drain Brush	00	6 ea	4.00/0.31
40147	4" Floor Drain Brush	00	6 ea	6.00/0.44
41093	5" Floor Drain Brush	00	6 ea	3.25/0.77
40148	6" Floor Drain Brush	00	6 ea	3.55/1.07
40236	36" Plastic Drain Brush Handle	00	12 ea	18.00/0.55
40237	48" Plastic Drain Brush Handle	00	12 ea	22.00/0.76

Boot 'N Shoe Brush

- Helps eliminate dirt, and other contaminants from being tracked into food prep and serving areas
- Chromed steel tube frame can be bolted to floor for security; brushes flip up to expose a steel scraper
- Non-absorbent plastic block construction with long lasting blue polypropylene bristles



Bowl Brushes

- Bowl brushes are available in a variety of styles and bristle materials
- 40140 has 180° bristle head to prevent splash-back
- 36232 and 36233 have all-natural cotton yarn securely attached to smooth wood handle



Ergonomic Force Cup

- Ergonomic design maximizes applied force while maintaining ease and longevity of use
- Over-molded rubber handle for easy grip
- 21" plastic handle is non-absorbent and more sanitary than wood handles

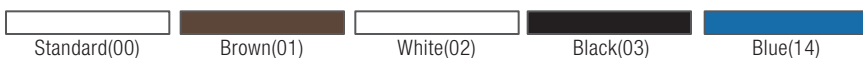

Prod No	Description	Handle Material	Color	Pack	Cs Wt/Cube
Boot 'N Shoe Brush					
40424	Boot 'N Shoe Brush	—	01, 03, 14	1 ea	5.60/1.22
40425	Boot 'N Shoe Brush Replacement	—	01, 03, 14	12 ea	17.00/1.33
Bowl Brushes					
40140	17" No-Splash Polyester Brush	Plastic	00	12 ea	7.00/1.28
36P5	17" Twist-In-Wire Synthetic Bristle Brush	Plastic	02	24 ea	7.50/2.08
3633	21" Twist-In-Wire Synthetic Bristle Brush	Plastic	00	24 ea	8.82/2.31
36232	10" Cotton Bowl Mop	Wood	00	36 ea	3.60/1.15
36233	20" Cotton Bowl Mop	Wood	00	36 ea	11.88/1.28
Ergonomic Power Plunger					
36439	Ergonomic Power Plunger	Plastic/Rubber	03	12 ea	6.68/0.72



HANDLE GUIDE

Prod No	Page	Description	Type of Handle	Recommended Handle
Duo-Sweep Brooms				
36859	263	7" Duo-Sweep Flagged Broom	Threaded	362019414
36863	263	9" Duo-Sweep Flagged Broom	Threaded	362019414
36883	263	11" Duo-Sweep Flagged Broom	Threaded	362019414
36860	263	7" Duo-Sweep Unflagged Broom	Threaded	362029403
36864	263	9" Duo-Sweep Unflagged Broom	Threaded	362029403
36884	263	11" Duo-Sweep Unflagged Broom	Threaded	362029403
Sweeps				
41880	265	18" Omni Sweep	Threaded	40225
41881	265	24" Omni Sweep	Threaded	40225
36204818	266	18" Foam Block Fine Sweep	Threaded	40225
36204824	266	24" Foam Block Fine Sweep	Threaded	40225
40564	266	18" Foam Block Medium Sweep	Threaded	40225
40565	266	24" Foam Block Medium Sweep	Threaded	40225
40561	266	18" Foam Block Medium Sweep	Threaded	40225
40562	266	24" Foam Block Medium Sweep	Threaded	40225
362208P18	266	18" Foam Block Medium Sweep	Threaded	40225
362208P24	266	24" Foam Block Medium Sweep	Threaded	40225
36207218	267	18" Foam Block Heavy Sweep	Threaded	40225
36207224	267	24" Foam Block Heavy Sweep	Threaded	40225
40621	267	18" Palmyra Heavy-Duty Sweep	Threaded/Tapered	40225
45222	267	24" Palmyra Heavy-Duty Sweep	Threaded/Tapered	40225
367618	267	18" Heavy-Duty Sweep	Threaded/Tapered	40267
367624	267	24" Heavy-Duty Sweep	Threaded/Tapered	40267
Floor & Deck Scrubs				
36175	270	10" Wood Block Sweep	Tapered	40261
36275	270	12" Wood Block Sweep	Tapered	40261
36193	270	10" Wood Block Scrub	Threaded/Tapered	40225
36192	270	10" Wood Block Sweep	Threaded/Tapered	40225
36292	270	12" Wood Block Scrub	Threaded/Tapered	40225
40423	270	10" Hi-Lo Floor Scrub Brush	Threaded	40225
36197	270	10" Dual Surface Scrub Brush	Threaded	40225
36190	270	10" Dual Action Scrub Brush	Threaded	40225
40422	270	10" Dual Action Scrub Brush	Threaded	40225
365300	271	8" Swivel Scrub	Threaded	40225
365310	271	8" Swivel Scrub	Threaded	40225
40430	271	9" Floor Scrub Brush	Threaded	40225
365320	271	Swivel Head Grout Brush	Threaded	40225
41323	271	9" Tile & Grout Brush	Threaded	40225



Prod No	Page	Description	Type of Handle	Recommended Handle
Floor Squeegees				
40081	272	18" Straight Steel Squeegee	Tapered	40261
40082	272	24" Straight Steel Squeegee	Tapered	40261
40083	272	30" Straight Steel Squeegee	Tapered	40261
366318	272	18" Straight Squeegee	Tapered	40261
366324	272	22" Foam Squeegee	Tapered	40261
366330	272	30" Soft Black Foam Rubber	Tapered	40261
366530	272	30" Red Foam Rubber Squeegee	Tapered	40261
366824	272	22" Foam Squeegee Threaded Socket	Threaded	40267
41567	273	18" Plastic Squeegee	Threaded	40225
41568	273	24" Plastic Squeegee	Threaded	40225
367814	273	14" Rubber Squeegee with Bristles	Threaded	40210
367818	273	18" Rubber Squeegee with Bristles	Threaded	40210
366918	273	18" Red Foam Rubber	Threaded	40210
366922	273	22" Red Foam Rubber	Threaded	40210
36324C	274	24" Curved End Black Rubber Squeegee	Tapered	40261
36336C	274	36" Curved End Black Rubber Squeegee	Tapered	40261
40078	274	24" Curved End Red Gum Rubber Squeegee	Tapered	40261
36567	274	20" Solid, One-Piece Rubber Squeegee	Threaded	40225
36568	274	24" Solid, One-Piece Rubber Squeegee	Threaded	40225
40075	275	18" Straight Steel Squeegee	Tapered	40261
40076	275	24" Straight Steel Squeegee	Tapered	40261
40077	275	36" Straight Steel Squeegee	Tapered	40261
36567	275	20" Rubber Squeegee	Threaded	40225
36568	275	24" Rubber Squeegee	Threaded	40225
Misc Floor Care				
40146	249	3" Floor Drain Brush	Threaded (Female)	40236
40147	249	4" Floor Drain Brush	Threaded (Female)	40237
41093	249	5" Floor Drain Brush	Threaded (Female)	40237
40148	249	6" Floor Drain Brush	Threaded (Female)	40238



CARLISLE
FOODSERVICE PRODUCTS

PROFESSIONAL
DURABLE
TOUGH
HARD-
WORKING
**TRANS-
PORTATION
EQUIPMENT**

Carlisle's high quality dollies, carts, and caddies help you reduce the risk of food contamination and employee injuries.





CARTS

Our unique combination of **space saving design, load capacity, and long-lasting durability** provide superior value and make Fold 'N Go the transport cart **every foodservice operation needs.**

Fold 'N Go® Carts

- Folds and unfolds in a single, quick and easy motion
- Each cart holds up to 350 lbs (approximately 116 lbs per shelf)
- Cart ships fully assembled; no tools or complicated latches required
- Collapses to 9" width and 10.5" width; stores easily behind doors, in between counters, or back of delivery vans
- Shelves are easy to clean; top shelf has ergonomically shaped, easy grip handles at both ends for a fast, secure grip
- SBC1521 shelf measures 20.5" L x 15" W; SBC2031 shelf measures 31.5" L x 18.5" W; with 11.5" shelf spacing
- 4" heavy-duty, non-marking swivel casters with molded-in metal reinforcement plates are permanently staked to .75" solid aluminum legs for longer life and added strength and rigidity

Licensed Product under U.S. Patent No. 5806864



SBC1521

SBC2031



350 lb Capacity



Easily folds with one hand

Replacements parts shown on pages 333



Bussing Carts

- Durable construction stands up to the toughest use
- Shelves are textured to minimize scratches and provide a better grip
- Convenient knockdown design is easy to assemble
- Available with optional back panels to hide clutter or locking doors to secure sensitive items like liquor or cleaning supplies (15" x 21" size only)



Replacements parts shown on pages 333



CC2036DP, available with locking doors and side panels to secure sensitive items

Trash container and silverware holder sold separately



Raised edges on shelves help keep contents secure during transport

Side panels help hide clutter

Durable construction will stand up to the toughest use



Prod No	Description	Weight Capacity	Color	Pack	Cs Wt/Cube
Fold 'N Go Carts					
SBC1521	15" x 21" Fold 'N Go Cart	350 lb	03, 23, 25	1 ea	45.45/6.89
SBC2031	20" x 31" Fold 'N Go Cart	350 lb	03, 23, 25	1 ea	51.00/10.60
SBCC240	Fold 'N Go Cart Replacement Caster, Swivel	—	00	1 ea	2.15/0.12
SBCC245	Fold 'N Go Cart Replacement Caster, Swivel with Brake	—	00	1 ea	2.15/0.12
Bussing Carts					
CC2243 Δ	42" x 23" Large Bussing Cart	300 lb	03	1 ea	69.00/9.89
CC2036 Δ	18" x 36" Bussing Cart	300 lb	03	1 ea	43.82/7.58
CC2036DP	18" x 36" Bussing Cart with Doors and Back Panels	300 lb	03	1 ea	51.75/11.59
CC2036P	18" x 36" Bussing Cart with Back Panels	300 lb	03	1 set	48.95/9.90
CD2036	18" x 36" Doors and Back Panels Only	—	03	1 set	7.93/1.93
CP2036	18" x 36" Back Panels Only	—	03	1 set	5.20/1.13
CC11SH	Accessory Bin for Bussing Cart	—	03	1 ea	5.16/1.26
CC11TH	Trash Bin for Bussing Cart	—	03	1 ea	9.23/3.18

NSF Listed products are designated with a Δ and may be prefixed with an N

Shipping Notes: CC2036 & SBC1521 can ship UPS/FedEx Ground at oversize cost, CC2243 & SBC2031 cannot ship UPS/FedEx Ground





CARTS

Stainless Steel Utility Carts

- Utility carts are constructed of heavy gauge stainless steel for superior strength and durability
- Continuous weld construction provides added durability as compared to other, spot welded utility carts
- Non-marking soft rubber bumpers prevent scratches and scuffs on walls



UC4031529



UC3031524



UC7022133

Service Cart

- One-piece design, all plastic construction
- Polyethylene exterior and polyurethane foam core for added strength
- Heavy-duty 5" non-marking caster with molded-in metal reinforcement plates
- Optional Trash Container (SBC11TC) and Part Holder (SBC11SH) available separately
- Replacement parts are listed on page 333
- NSF Listed



SBC230 with SBC11TC and SBC11SH



Black(03)

Prod No	Description	Weight Capacity	Color	Pack	Cs Wt/Cube
Service Cart					
SBC230 Δ	Service Cart - 2 Fixed Casters, 2 Swivel Casters, 1 with Brake	500 lb	03	1 ea	57.00/14.29
SBC11SH	Part Holder for SBC230	—	03	1 ea	3.50/0.89
SBC11TC	Trash Container for SBC230	—	03	1 ea	9.15/2.17
Stainless Steel Utility Carts					
UC3031524	15.5" x 24", 3 Shelf Utility Cart	300 lb	—	1 ea	37.00/13.70
UC3031827	18" x 27", 3 Shelf Utility Cart	300 lb	—	1 ea	43.00/13.70
UC5031524	15.5" x 24", 3 Shelf Utility Cart	500 lb	—	1 ea	43.00/13.70
UC5031827	18" x 27", 3 Shelf Utility Cart	500 lb	—	1 ea	52.00/15.51
UC5032135	21" x 35", 3 Shelf Utility Cart	500 lb	—	1 ea	70.00/23.54
UC7031524	15.5" x 24", 3 Shelf Utility Cart	700 lb	—	1 ea	75.00/13.70
UC7031827	18" x 27", 3 Shelf Utility Cart	700 lb	—	1 ea	86.00/15.51
UC7022133	21" x 33", 2 Shelf Utility Cart	700 lb	—	1 ea	94.00/23.54
UC7032133	21" x 33", 3 Shelf Utility Cart	700 lb	—	1 ea	109.00/23.54
UC4031529	15.75" x 29.5", 3 Shelf Knock-Down Utility Cart	400 lb	—	1 ea	31.00/2.50
UC4031733	17.75" x 33.38", 3 Shelf Knock-Down Utility Cart	400 lb	—	1 ea	33.00/3.20

NSF Listed products are designated with a Δ and may be prefixed with an N

Shipping Notes: SBC230, UC3031524, UC3031827, UC5031524, UC5031827, UC5032135, UC7031524, UC7031827, UC7022133, UC7032133 cannot ship UPS/FedEx



Utility Carts

- Excellent for transporting equipment and heavy loads
- Bin top utility carts (UC4018 & UC4525) reduce the potential for items to fall off during transport
- Durable and chemical-resistant polypropylene construction; will not rust, dent, chip, or peel
- Convenient knock-down design
- Integrated cord wrap for easy access (UC1940)



UC1940



UC4018

Gray(23)

Prod No	Description	Weight Capacity	Color	Pack	Cs Wt/Cube
Utility Carts					
UC1940	19" x 40" x 32.5" Utility Cart	500 lb	23	1 ea	45.05/5.29
UC4018	40" x 17.25" Small Bin Top Utility Cart	500 lb	23	1 ea	35.27/3.31
UC4525	45" x 25" Large Bin Top Utility Cart	500 lb	23	1 ea	41.45/5.82



DISH DOLLIES

Optimizer™ Adjustable Dish Dollies

- Adjustable dividers eliminate the need for individually sized dollies
- Dollies hold plates from 5.5" to 12.5"
- Polyethylene dividers and walls help prevent dish edge chipping
- Two-handed access to all plates reduces breakage
- Non-marking casters (2 locking, 2 non-locking) for easy transport of loaded dollies
- Includes vinyl cover with easy-opening hook & loop side included for sanitary storage
- Replacement parts are listed on page 333
- NSF Listed



ADD4, ADD6 Optimizer Dollies Also Feature:

- Most flexible dolly available; holds trays, plates, and platters
- ADD6 holds oval platters from 9.5" x 7.25" to 13.5" x 10.5"
- Holds 5 stacks of 9.88" to 11.25" plates; 25% more than any other similar dish dolly
- Holds 8 stacks of 5.5" to 8.25" plates; 33-50% more than any other similar dish dolly (up to 50 or more plates per stack, depending on plate profile)
- Use 2 to 4 dividers for 10" or larger plates; 6 dividers for 8" to 9.75" plates; 8 dividers for 8 stacks of 7.75" or smaller plates
- 2 dividers for 13.5" x 10.5" platters; 6 dividers for 9.5" x 7.25" to 12" x 9.25" platters.

ADS4, ADS8 Optimizer Dollies Also Feature:

- Smaller size fits through narrow corridors or under tables
- Flexible configuration holds a variety of plates and platters



ADS4



ADD4

ADD6 Vinyl Cover with ADD6



WARNING: Products identified on this page with the following symbol ▼ contain chemicals, including one or more phthalates, known to the State of California to cause cancer and birth defects and other reproductive harm.



Prod No	Description	Color	Pack	Cs Wt/Cube
Optimizer Standard Dish Dollies & Accessories				
ADD4 ▲	Optimizer Dish Dolly with 4 Dividers	01, 03	1 ea	93.00/23.84
ADD6 ▲	Optimizer Dish Dolly with 6 Dividers	01, 03	1 ea	96.20/23.84
ADD4 ▼	Optimizer Replacement Dividers (Set of 2)	01, 03	2 ea	4.70/0.47
ADD6 ▼	Optimizer Vinyl Replacement Cover (for ADD4 or ADD6)	07	1 ea	2.10/0.31
ADDR	Divider Replacement Hardware (Rod, Washers, Knob)	03	4 ea	0.10/0.04
Optimizer Small Dish Dollies & Accessories				
ADS4 ▲	Optimizer Small Dish Dolly and 4 Adjustable Dividers	03	1 ea	65.00/16.87
ADS8 ▲	Optimizer Small Dish Dolly and 8 Adjustable Dividers	03	1 ea	70.00/20.14
ADSD	Optimizer Replacement Dividers (Set of 4)	03	1 ea	10.00/1.01
ADSD ▼	Optimizer Vinyl Replacement Cover (for ADS4 or ADS8)	07	1 ea	2.10/0.31

NSF Listed products are designated with a ▲ and may be prefixed with an N
 Note: ADD4, ADD6, ADS4, ADS8 cannot ship UPS/FedEx

Optimizer Adjustable Dish Dolly Guide

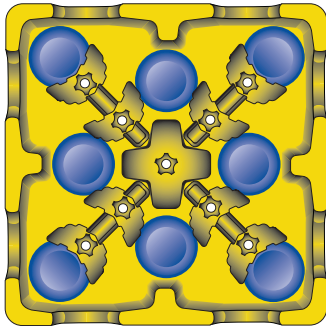

ADS8 Layout for 5.5" plates

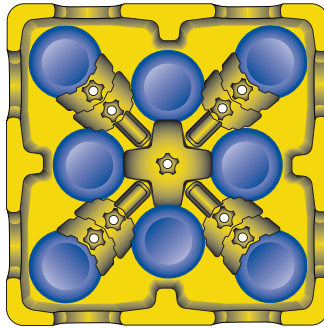

ADS8 Layout for 6.5" plates

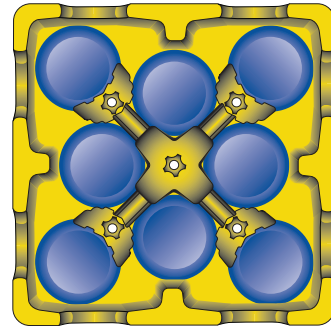

ADS4 Layout for 7.5" plates

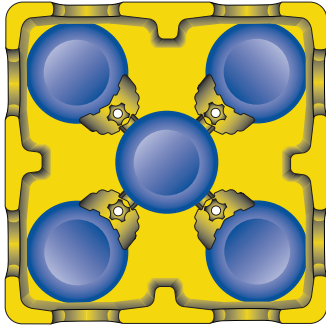

ADS4 Layout for 9" plates

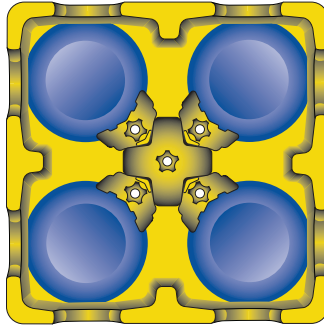

ADS4 Layout for 11" plates

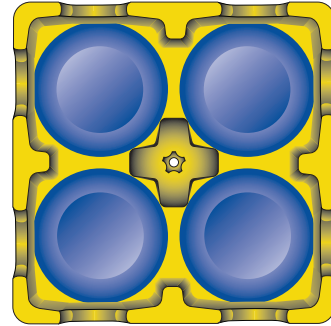

ADS4 Layout for 12" plates

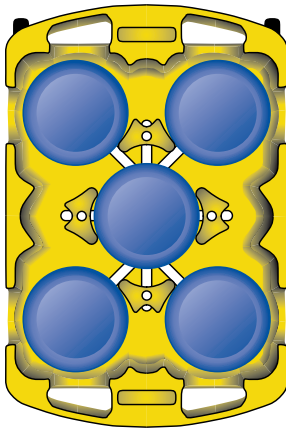

ADD4 Layout for 9.88" to 11.25" plates

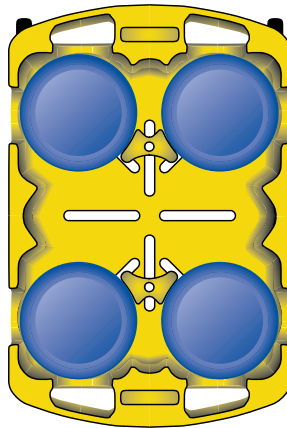

ADD4 Layout for 11.38" to 12.5" plates and 13.5" by 10.5" platters

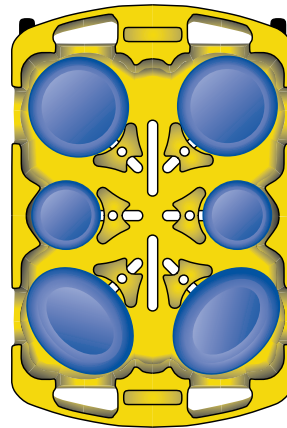

ADD6 Layout for 12" by 9" to 9.5" by 7.25" platters, 5.5" to 8" plates and 5.5" to 12" plates

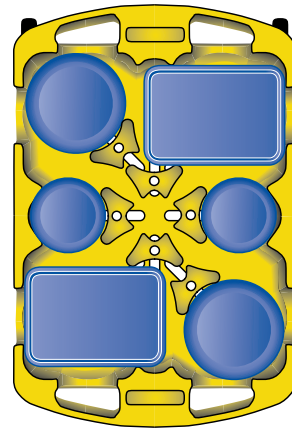

ADD6 Layout for 10" by 14.5" trays and 7.5" plates and 10" plates

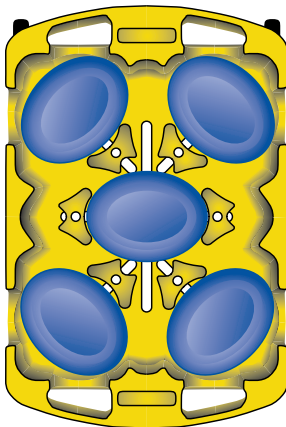

ADD6 Layout for 12" by 9.25" to 9.5" by 7.25" platters

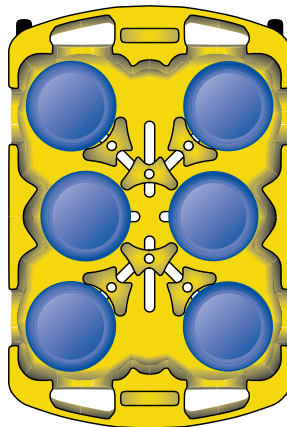

ADD6 Layout for 8.38" to 9.75" plates

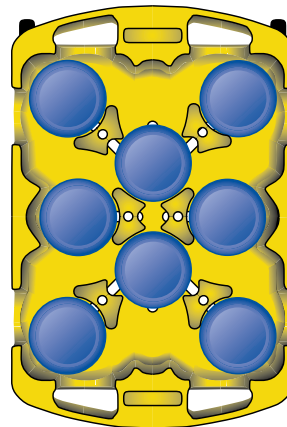

ADD6 Layout for 8" to 8.25" plates

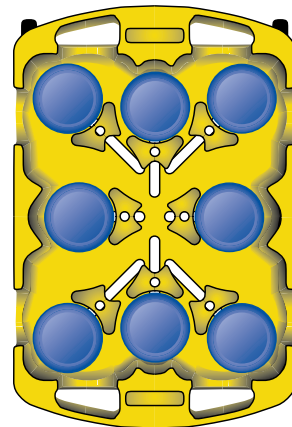

ADD6 Layout with 2 Additional Dividers for 5.5" to 7.88" plates



JANITORIAL CARTS

Janitorial Carts & Accessories

- Rugged polypropylene resists cracking, peeling, and corrosion
- Three durable shelves with raised edges keep items organized
- Platform base holds a Bucket/Wringer or 23 gallon TrimLine™ Waste Container
- Includes a 25 gallon nylon bag for waste or laundry collection
- 3" standard Carlisle non-marking swivel casters in front; large 8" non-marking rear wheels





Integrated tool holders, shelves, and hooks keep everything organized including unwieldy handles.



Front hooks hold most standard Wet Floor Signs. Built-in hanger holds multiple spray bottles.



Structurally reinforced base and heavy-duty casters/wheels withstand rough use – holds up to 300 lbs.



Tough 25 gallon nylon bag easily attaches to cart arm. Hooks on top of arm to hold trash liners in place. Arm swings up for more compact storage when not in use.



JC1945CB

Tool Caddy

- Handled caddy fits in the top compartment of the JC1945 cart series
- Deep compartments prevent spills
- Made of durable polypropylene



Prod No	Description	Weight Capacity	Color	Pack	Cs Wt/Cube
Janitorial Carts & Accessories					
JC1945S	45"L x 19"W x 39"H Short Platform Janitorial Cart	300 lb	23	1 ea	33.00/4.45
JC1945L	49"L x 19"W x 39"H Long Platform Janitorial Cart	300 lb	23	1 ea	41.00/4.49
JC1946	Replacement Bag for JC1945S & JC1945L	—	14	1 ea	1.14/0.06
JC1945CB	Tool Caddy for Janitorial Cart	—	23	1 ea	8.25/1.52
36908C	3" Replacement Casters	—	00	2 ea	8.0/2.88



CARLISLE

TT175

WHEEL WEIGHT: 50.0 / 21kg

CARLISLE
FOODSERVICE PRODUCTS



RUGGED
QUALITY
DURABLE
**WASTE
MANAGEMENT
PRODUCTS**

Carlisle offers a solution for all of your waste and material handling needs. Our products are built to last and feature the rugged construction and durability you expect.





WASTE CONTAINERS & LIDS

When it comes to **waste and material handling**, you can count on Carlisle to deliver products designed for **heavy duty usage**.

Bronco™

- Heavy-duty construction with double-reinforced stress ribs; drag skids for durability
- Comfort Curve™ handles provide easy handling
- Helper handles on base for controlled tipping or overhead lifting
- Reinforced lids have snap down tab locks with a simple press & pull release system for easy removal
- NSF Std 21 – meets the criteria for thermoplastic refuse containers
- NSF Std 2 – meets the criteria for food contact and cleanability

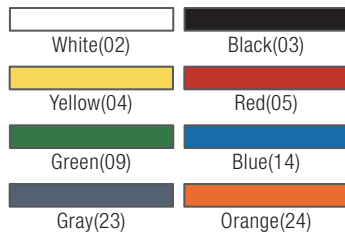

Prod No	Description	Color	Pack	Cs Wt/Cube
Bronco Round Waste Containers & Lids				
341010 Δ	10 gal Waste Container, 16.13" x 17"	02, 04, 05, 09, 14, 23, 24	6 ea	16.50/5.45
341011 Δ	10 gal Lid, 16.13" x 2"	02, 04, 05, 09, 14, 23, 24	6 ea	5.50/0.77
341020 Δ	20 gal Waste Container, 20" x 23"	02, 04, 05, 09, 14, 23, 24	6 ea	34.80/10.97
341021 Δ	20 gal Lid, 20" x 2.13"	02, 04, 05, 09, 14, 23, 24	6 ea	7.65/4.57
341032 Δ	32 gal Waste Container, 22.38" x 27.75"	02, 04, 05, 09, 14, 23, 24	4 ea	34.40/13.18
341033 Δ	32 gal Lid, 24" x 2.13"	02, 04, 05, 09, 14, 23, 24	4 ea	7.65/2.47
341034	32 gal Dome Lid	03	1 ea	9.20/4.01
341035	32 gal Funnel Lid	03	4 ea	2.42/1.46
341044 Δ	44 gal Waste Container, 26.88" x 31.38"	02, 04, 05, 09, 14, 23, 24	3 ea	38.40/10.24
341045 Δ	44 gal Lid 26.88" x 2.25"	02, 04, 05, 09, 14, 23, 24	3 ea	8.70/2.06
341055 Δ	55 gal Waste Container, 26.5" x 33"	02, 04, 05, 09, 14, 23	2 ea	53.80/26.23
341056 Δ	55 gal Lid, 26.5" x 2.25"	02, 04, 05, 09, 14, 23	2 ea	7.65/3.20
341057	44/55 gal Dome Lid	03	1 ea	12.40/6.68
341132 Δ	32 gal Container with Dolly, 22.38" x 38.25"	02, 04, 05, 09, 14, 23	4 ea	66.40/17.04
341144 Δ	44 gal Container with Dolly, 26.88" x 37.75"	02, 04, 05, 09, 14, 23	3 ea	57.90/20.41

NSF Listed products are designated with a Δ and may be prefixed with an N

7 Colors

Our round Bronco containers come in 8 colors and are made with NSF 2 certified materials which meet the criteria for food contact and cleanability. Excellent for storing and segregating large amounts of food products.



Hot Stamped Bronco™ Containers

- Carlisle offers several standard Hot Stamped containers for waste management, visit carlislefsp.com/custom-imprinting
- Standard stamps:
 - INEDIBLE
 - USDA CONDEMNED
 - TRASH
 - ICE ONLY
- Custom hot stamping is also available; see page 323 for more information



341010ICE

Tool Caddy Bag

- Economical, adjustable caddy bag can hold an assortment of cleaning tools
- Turns a 32 or 44 gallon Bronco into a portable and durable cleaning system platform



36917

Carlisle Dollies

- Dollies fit our 20, 32, 44, and 55 gallon containers for safe transport of heavy loads
- Simple twist-to-lock feature securely attaches dolly to containers
- Dollies include standard Carlisle non-marking 3" swivel casters
- NSF Std 2—meets the criteria for food contact and cleanability



36910

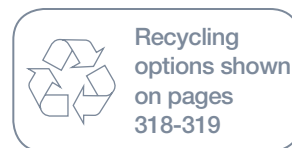

Prod No	Description	Color	Pack	Cs Wt/Cube
Hot Stamped Bronco Container				
341010ICE Δ	10 gal "Ice Only" Container	02	6 ea	16.50/5.45
Tool Caddy Bag				
36917	Tool Caddy Bag for 32 & 44 gal Bronco Waste Containers	04	12 ea	14.74/1.78
Carlisle Dollies				
36911 Δ	Standard Round Container Dolly, 17.75" x 6"	03	2 ea	10.00/1.30
36910 Δ	Round Container Dolly with Replaceable Casters	03	2 ea	13.00/1.69
3672231	3" Replacement Caster for 36910 Dolly	—	1 ea	1.00/0.01

NSF Listed products are designated with a Δ and may be prefixed with an N



WASTE CONTAINERS & LIDS

Square Bronco™

- Heavy-duty construction with double-reinforced stress ribs; drag skids for durability
- Comfort Curve™ handles provide easy handling
- Helper handles on base for controlled tipping or overhead lifting
- Reinforced lids have snap down tab locks with a simple press & pull release system for easy removal



Prod No	Description	Color	Pack	Cs Wt/Cube
Square Bronco Waste Containers & Lids				
341528	28 gal Square Bronco Waste Container	02, 23	6 ea	8.76/0.16
341529	Square Bronco Lid for 341528	02, 23	6 ea	2.34/0.17
341540	40 gal Square Bronco Waste Container	02, 23	4 ea	12.65/0.25
341541	Square Bronco Lid for 341540	02, 23	4 ea	3.10/0.02
341542	Dolly for 28/40 gal Square Bronco Container	03	2 ea	4.84/0.03

50 Gallon Roll-Away Container

- Super heavy-duty axle and oversize traction wheels make hauling heavy loads easy
- Unique handle design gives positive grip even when wet
- Sturdy hinged lid flips open 270° and snaps shut tight
- NSF Std 21 – meets the criteria for thermoplastic refuse containers
- NSF Std 2 – meets the criteria for food contact and cleanability



345050



56 Gallon

- High capacity for indoor or outdoor use
- Corner tabs keep bag in place
- Can be used with two 23 gallon TrimLines to separate waste
- Hooded top available with or without doors
- Self-venting design for easier bag removal
- Rigid liner also available 344042



344042
with 23 gal TrimLines



344056

344058

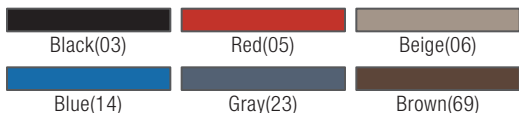

Prod No	Description	Color	Pack	Cs Wt/Cube
Roll-Away Container				
345050 Δ	50 gal Rolling Container, 21" x 21" x 38.25"	14, 23	2 ea	42.80/16.48
56 Gallon Container				
344056	56 gal Waste Container	06, 69	1 ea	16.50/11.68
344057	Hooded Top Without Doors for 344056	05, 69	1 ea	7.90/5.14
344058*	Hooded Top With Doors for 344056	05, 69	1 ea	7.90/5.14
344042	Rigid 42 gal Liner for 344056	03	4 ea	9.64/6.89

NSF Listed products are designated with a Δ and may be prefixed with an N

*344058 not compatible with 56 gal Waste Container (344056) when used with the Rigid 42 gal Liner (344042)



WASTE CONTAINERS & LIDS

Centurian™

- Attractive yet durable
- Self-venting design for easier bag removal
- Corner tabs keep bag in place



Prod No	Description	Color	Pack	Cs Wt/Cube
Centurian Waste Containers				
343021	21 gal Half Round Centurian Container	06, 23	4 ea	6.51/3.99
343022	Half Round Centurian Lid for 343021	03, 06, 23	4 ea	9.20/3.44
343122	22 gal Tall Round Centurian Container	23	4 ea	6.35/4.35
343123	Swing Top Centurian Lid for 343122	23	4 ea	8.00/2.09
343124	Funnel Top Centurian Lid for 343122	23	4 ea	5.29/1.62
343523	23 gal Tall Square Centurian Container	06, 23, 69	4 ea	6.70/3.82
343525	Swing Top Centurian Lid for 343523	03, 06, 23, 69	4 ea	9.50/2.50
343935	35 gal Centurian Square Waste Receptacle	06, 23	4 ea	7.35/6.62
343950	50 gal Centurian Square Waste Receptacle	06, 23	4 ea	9.00/8.19
343951	Large Centurian Lid for 343935, 343950	06, 23	4 ea	26.40/4.23



TrimLine™

- Designed for narrow spaces
- Self-venting for easier bag removal
- Corner tabs keep bag in place
- Helper handle on bottom makes lifting and dumping easier



Wire Dolly

- Compact design for easy storage
- For use with 23 gallon size container
- 100 lb weight capacity



Prod No	Description	Color	Pack	Cs Wt/Cube
TrimLine Containers				
342015	15 gal TrimLine Container	06, 23	4 ea	5.70/3.16
342023	23 gal TrimLine Container	03, 06, 09, 14, 23, 69	4 ea	29.60/5.91
342024	TrimLine Swing Top Lid, 20.13" x 11.5" x 4.5"	03, 06, 23, 69	4 ea	10.88/2.36
342025	TrimLine Handled Lid, 20.5" x 11.5" x 3"	03, 06, 09, 14, 23	4 ea	7.76/0.90
36920-1	Wire Frame Dolly for 23 gal TrimLine Container	03	1 ea	12.50/2.37



WASTE CONTAINERS & LIDS

Step-On Containers

- Hands free design minimizes contact with waste
- Color-coded lids to designate and segregate types of waste
- Chemical resistant and corrosion-proof
- Assists in complying with OSHA regulation 29CFR 1910.1030, "Occupational and Bloodborne Pathogens"



Prod No	Description	Color	Pack	Cs Wt/Cube
Step-On Beige Containers with Color-Coded Lids				
346144	12 gal Step-On Container	02, 05, 06	1 ea	7.91/3.55
346145	18 gal Step-On Container	02, 05, 06, 09, 14	1 ea	12.68/4.79
346146	23 gal Step-On Container	02, 05, 06, 09, 14	1 ea	15.40/5.70



Office Wastebaskets

- Economical polypropylene
- Smooth inner surface makes cleaning easy
- Light yet durable design

 Recycling options shown on pages 318-319



Fire Resistant Wastebaskets

- Ideal for use in areas or applications requiring an extra degree of fire protection including schools, health care, and hospitality
- Textured finish minimizes appearance of scuffs and scratches
- UL Listed; will contain burning paper without contributing fuel to the fire



Prod No	Description	Color	Pack	Cs Wt/Cube
Office Wastebaskets				
342913	13 qt Office Wastebasket	03, 06, 23	12 ea	42.24/2.07
342928	28 qt Office Wastebasket	03, 06, 23	12 ea	51.48/4.02
342941	41 qt Office Wastebasket	03, 06, 23	12 ea	88.00/5.90
Fire Resistant Wastebaskets				
342915	14 qt Fire Resistant Wastebasket	03	6 ea	20.00/0.67
342927	28 qt Fire Resistant Wastebasket	03	6 ea	33.00/1.22
342940	41 qt Fire Resistant Wastebasket	03	4 ea	32.00/3.07

RECYCLE CONTAINERS & ACCESSORIES

Recycle options are great for offices, hospitality, industrial, restaurants, and more.

Bronco™



Centurian™



Prod No	Description	Color	Pack	Cs Wt/Cube
Bronco Recycle Waste Containers & Lids				
341020REC Δ	20 gal Recycle Waste Container	09, 14	6 ea	34.80/10.97
341021REC Δ	20 gal Recycle Lid with 8" Hole	09, 14	6 ea	7.65/4.57
341032REC Δ	32 gal Recycle Waste Container	09, 14	4 ea	34.40/13.18
341033REC Δ	32 gal Recycle Lid with 8" Hole	09, 14	4 ea	7.65/2.47
341044REC Δ	44 gal Recycle Waste Container	09, 14	3 ea	38.40/10.24
341045REC Δ	44 gal Recycle Lid with 8" Hole	14	3 ea	8.70/2.06
Centurian Recycle Waste Containers & Lids				
343021REC	21 gal Half Round Centurian Recycle Container	14	4 ea	6.51/3.99
343022	Half Round Centurian Lid for 343021REC	03	4 ea	9.20/3.44
343523REC	23 gal Tall Square Centurian Recycle Container	14	4 ea	6.70/3.82
343526REC	Paper Recycle Centurian Lid for 343523REC	14	4 ea	9.0/2.50
343527REC	Bottle/Can Recycle Centurian Lid for 343523REC	14	4 ea	9.0/2.50
343935REC	35 gal Recycle Centurian Square Waste Receptacle	14	4 ea	7.35/6.62
343950REC	50 gal Recycle Centurian Square Waste Receptacle	14	4 ea	9.00/8.19
343936REC	Bottle/Can Recycle Centurian Lid for 343935REC, 343950REC	14	4 ea	5.0/4.12
343937REC	Paper Recycle Centurian Lid for 343935REC, 343950REC	14	4 ea	5.0/2.65
34RECLBL	Recycle Label Kit	—	1 ea	0.30/0.01

NSF Listed products are designated with a Δ and may be prefixed with an N

TrimLine™



Roll-Away



Office Wastebaskets



56 Gallon



Recycle Label Kit



34RECLBL

Includes one set of eleven color-coded symbol labels and three sets of eleven word labels in English, Spanish and French

Prod No	Description	Color	Pack	Cs Wt/Cube
TrimLine Recycle & Compost Containers & Lids				
342015REC	15 gal TrimLine Recycle Container	14	4 ea	5.7/3.16
342023REC	23 gal TrimLine Recycle Container	09, 14	4 ea	29.60/5.91
342023CMP	23 gal TrimLine Compost Container	09	4 ea	29.60/5.91
342026REC	Paper Recycle Lid for 343023REC & 342015REC	14	4 ea	4.25/1.82
342027REC	Bottle/Can Recycle Lid for 343023REC & 342015REC	14	4 ea	4.25/1.82
342025	TrimLine Handled Lid	03, 09, 14	4 ea	5.10/0.90
Carlisle Roll-Away Recycle Container				
345050REC Δ	50 gal Recycle Rolling Container	14	2 ea	42.80/16.48
56 Gallon Recycle Container & Lid				
344056REC	56 gal Recycle Waste Container	14	1 ea	16.50/11.68
344057REC	Recycle Lid for 344056REC	14	1 ea	1.50/7.88
Office Recycle Wastebaskets				
342913REC	13 qt Office Recycle Wastebasket	14	12 ea	42.24/2.07
342928REC	28 qt Office Recycle Wastebasket	14	12 ea	51.48/4.02
342941REC	41 qt Office Recycle Wastebasket	14	12 ea	88.00/5.90
Recycle Label Kit				
34RECLBL	Recycle Label Kit	—	1 ea	0.30/0.01

NSF Listed products are designated with a Δ and may be prefixed with an N



TILT TRUCKS

- Durable, rotationally molded construction with sturdy, reinforced rim and molded-in handles
- Smooth inner surface makes cleaning easy
- Textured outer surface hides scratches and helps maintain daily appearance
- Perfect for transporting bulky loads and/or consolidating smaller loads for more efficient transport
- Made with post consumer recycled material
- Meets EPA recommended recovered materials content levels for office recycling containers and waste receptacles and is perfect for specifying on school and government agency bids
- Rear wheels: 5" swivel casters with rubber tread
- Front wheels: 12" HDPE injection molded wheels
- Easy on/off wheels for quick replacement





TT005



TT175



TT110

Black(03)

Prod No	Description	Weight Capacity	Color	Pack	Cs Wt/Cube
Tilt Trucks					
TT005	.5 Cubic Yard Utility Duty Tilt Truck	400 lb/182 kg	03	1 ea	80.25/36.59
TT105	.5 Cubic Yard Standard Duty Tilt Truck	825 lb/374 kg	03	1 ea	87.25/36.59
TT175	.75 Cubic Yard Standard Duty Tilt Truck	825 lb/374 kg	03	1 ea	100.00/42.99
TT010	1 Cubic Yard Utility Duty Tilt Truck	825 lb/374 kg	03	1 ea	124.25/59.58
TT110	1 Cubic Yard Standard Duty Tilt Truck	1200 lb/544 kg	03	1 ea	130.25/59.58

IN THIS SECTION

Here, you will find basic information on how to get custom decorated or logo'd products and find replacement parts for Carlisle products you already have. The index below will guide you through this section. Page references will direct you back to the catalog section where specific products are located. **All information is listed in catalog order.**

Index	
Custom Imprinting	324-325
Durus® Warranty	334
Replacement Parts	328-333

To access this and other helpful information and learn more about all of our latest products visit www.carlislefsp.com.

You can locate all of our product Tech Specs – dimensions, capacities, material, and more by visiting our website and selecting the Tech Specs tab on the section intro. This information is also easily accessed from any of the individual product listings in our on-line catalog. We also offer extensive on-line resources where you can find more in-depth information on all of our products.

Our web site is packed with everything you could ever need to know about our products and services.

Information like:

- Complete Technical Specifications for all Carlisle products – including dimensions, capacities, material content, electrical information, and more
- Product Specification Sheets
- Care and Use Instructions
- Details on our many money-saving Warranties
- Dinnerware Shapes and Profiles
- Additional Replacement Parts
- Food Bar Pan Layouts
- OptiClean Glass Rack Sizing Guide – including convenient glass-to-rack reference guides for all major Drinkware manufacturers along with our exclusive Glass Rack Wizard
- Brush and Bristle Guides – to help you select the proper brush for any cleaning job

Visit our website to see how to qualify for rebates and other special offers direct from Carlisle that can save you hundreds of dollars on the professional quality foodservice and cleaning tools your operation uses every day.

HOT STAMPING

Café & Bistro Trays

Available for Café and Bistro Trays shown on page 141.

Lead Time - 6 weeks from approval of sample.

Imprint Charge - \$0.35 net each piece.

Artwork Charge - Camera-ready artwork required or a \$100.00 per hour art charge.

Set-Up Charge - \$50.00 net per order.

Plate Charge - One time charge of \$80.00 net to purchase die on artwork 5"H x 7"W or less.

Note - Decorating limited to one color. To provide you the best hot stamp tray possible, the supplied artwork should not have any bold detail. All bold or large wording should be in outline format with lines at least 1/8" and up to 1/4".



Prod No	Description	Max Imprint H x W	Min Order Qty
CT1014	14" x 10" Café Tray	5" x 7"	288 ea
CT1216	16" x 12" Café Tray	5" x 7"	288 ea
CT1217	17" x 12" Handled Café Tray	5" x 7"	288 ea
CT1418	18" x 14" Café Tray	5" x 7"	288 ea
CT1713TR	18" x 14" Trapezoid Café Tray	5" x 7"	288 ea
1217BT	12" x 17" Bistro Tray	5" x 7"	288 ea
1319BT	13" x 19" Bistro Tray	5" x 7"	288 ea

Bronco/TrimLine Waste Containers

Available for Bronco and TrimLine Waste Containers shown on pages 310-315.

Lead Time - 4 weeks from receipt of approved artwork.

Imprint Charge - \$2.00 net each piece, per side.

Artwork Charge - One-time art and plate charge ranging up to \$780.00 net.

Available Ink Colors - Black, White

For reorders, please allow 10 working days.

Bronco



TrimLine



Prod No	Description	Max Imprint Shoulder H x W	Max Imprint Belly H x W	Min Order Qty
341010	10 gal Bronco Container	2" x 8"	7" x 9.25"	96 ea
341020	20 gal Bronco Container	2.5" x 8"	9" x 8.5"	96 ea
341032	32 gal Bronco Container	3.25" x 10'	11.5" x 13.5"	96 ea
341044	44 gal Bronco Container	3.25" x 10'	11.5" x 13.5"	96 ea
341055	55 gal Bronco Container	6" x 13"	14" x 13"	96 ea
345050	50 gal Rolling Container	—	10" x 10"	96 ea
342023	23 gal TrimLine Container	7.5" x 7.75" (Wide Side)	3" x 5.5" (Narrow Side)	96 ea

CUSTOM IMPRINTING

Camera-Ready Artwork For Silk Screening

- Digital artwork must be high resolution (300 DPI) as an EPS, PDF, TIFF, or JPG. Artwork should be sent in the original format in which it was created. Artwork must also be properly separated when more than one color is used.
- At customer's request, we will prepare camera-ready art at an artist fee of \$100.00/hour.
- Since the design possibilities are governed by the item to be imprinted, details of all artwork must be submitted to Carlisle FoodService Products for consideration before an order can be accepted.

Samples

- With a firm order, we will provide ONE sample for approval before final production.
- A NET charge of \$75.00 must be paid in advance to request one imprint sample without a firm purchase order. This charge also applies if your order is canceled after receipt of sample, prior to production. The \$75.00 NET charge is in addition to the set-up charge.

Set-Up Charge

- \$50.00 net for one color, one side. \$25.00 net for each additional color and side.
- One-time film charge of \$15.00 net per color. Charge covers 8.5" x 11" film.

Terms

- Delivery of plus or minus 10% within the quantity ordered constitutes fulfillment of the order and payment shall be made on the basis of actual delivery.

Returns

- Custom decorated products are not accepted for exchange or refund.

Case Lots

- All orders sold in full case lots only.

Questions

- Contact your local Carlisle Sales Representative or your Customer Service Representative for more information.



Silk Screening

Product List A

Lead Time – 6 weeks from approval of sample.

Imprint Charge – \$0.35 net each piece, per side, per color.

Prod No	Description	Max Imprint H x W	Min Order Qty	Prod No	Description	Max Imprint H x W	Min Order Qty
0240*	10.5" Ladle	.5" x 3"	144 ea	4109*	9" Utility Tong (Clear only)	.38" x 2"	144 ea
0295*	9.5" Carly Ladle	.25" x 2"	144 ea	4112*	12" Utility Tong (Clear only)	.38" x 2.25"	144 ea
0296*	13.5" Carly Ladle	.25" x 3"	144 ea	4206*	6" Pom Tong (Clear only)	.38" x 1.25"	144 ea
0301	1.2 qt Classic Crock	3" x 13"	144 ea	4250	Handled Shaker Dredge	3" x 2.25"	144 ea
0302	2.7 qt Classic Crock	4.5" x 11"	144 ea	4260	Handled Shaker Dredge	3" x 2.25"	144 ea
0304	4 qt Classic Crock	4" x 9"	144 ea	4270	Handled Shaker Dredge	3" x 2.25"	144 ea
0316	1.5 qt Classic Crock	1.5" x 11"	144 ea	43052	10 oz Stackable Mug	1" x 7"	144 ea
0365*	1.5 qt Supreme Crock (on lip)	.75" x 11"	144 ea	4332	32 oz Scoop (print on side)	.25" x 3"	144 ea
0372*	2.7 qt Supreme Crock (on lip)	.75" x 11"	144 ea	43622	13.5 oz Liberty PC Goblet	.5" x 4"	1008 ea
4009*	9" Salad Tong (Clear only)	.38" x 2"	144 ea	43625	18 oz Liberty PC Double Old Fashion	.5" x 4"	1008 ea



Product List A (cont.)

Prod No	Description	Max Imprint H x W	Min Order Qty
43626	22 oz Liberty PC Hi-Ball	1" x 10.5"	1008 ea
43630	13 oz Liberty PC	4.33" x 7.81"	1008 ea
4410*	11" Solid Serving Spoon	.25" x 4"	144 ea
4411*	11" Perforated Serving Spoon	.25" x 4"	144 ea
4420*	13" Solid Serving Spoon	.25" x 4"	144 ea
4421*	13" Perforated Serving Spoon	.25" x 4"	144 ea
4430*	15" Solid Serving Spoon	.25" x 4"	144 ea
4431*	15" Perforated Serving Spoon	.25" x 4"	144 ea
4450*	.25 oz 8" Solid Buffet Spoon	.25" x 1.5"	144 ea
4460*	.5 oz 8" Solid Buffet Spoon	.25" x 1.5"	144 ea
4470*	.75 oz 10" Solid Buffet Spoon	.25" x 1.5"	360 ea
4471*	.75 oz 10" Perforated Buffet Spoon	.25" x 1.5"	360 ea
4512	12 oz Jumbo Soup Mug	1.25" x 8"	144 ea
4550	Standard Sugar Caddy	1.25" x 2"	144 ea
4551	Merchandiser Sugar Caddy	1" x 7"	144 ea
4571	8 oz J-Jar	1.5" x 8.5"	144 ea
4900	Slotted Turner	.5" x 2"	144 ea
509	11" Solid Salad Spoon	.25" x 4.5"	144 ea
5109-2	9.5 oz PC Stackable Tumbler	1.25" x 6"	1008 ea
5112-2	12 oz PC Stackable Tumbler	3.5" x 8"	1008 ea
5116-2	16 oz PC Stackable Tumbler	3" x 7.25"	1008 ea
5120	20 oz PC Stackable Tumbler	5.5" x 10"	1008 ea
5212	12 oz Stackable Tumbler	3.5" x 8"	1008 ea
5216	16 oz Stackable Tumbler	3" x 7.25"	1008 ea
5220	20 oz Stackable Tumbler	5.5" x 10"	1008 ea
5224	24 oz Stackable Tumbler	5.5" x 10"	1008 ea
5232	32 oz Tall Stackable Tumbler	5.5" x 8"	1008 ea
5506	9.5 oz Stackable Tumbler	1.25" x 6"	1008 ea
5532	32 oz Stackable Tumbler	4" x 6"	1008 ea
5601*	1.5 oz Alibi Shot	1.25" x 2.75"	1008 ea
5602*	2 oz Alibi Shooter	1.25" x 3"	1008 ea
5603*	3 oz Alibi Shooter/Mini Dessert	1.25" x 3"	1008 ea
5614*	14 oz Alibi Beverage	2" x 8.5"	1008 ea
5616*	16 oz Alibi Pint/Mixing	3.25" x 4"	1008 ea
5640*	8 oz Alibi Champagne Flute	1.25" x 7"	1008 ea
5810*	10 oz Louis Tumbler	.5" x 9.25"	1008 ea
5816*	16 oz Louis Tumbler	.75" x 10"	1008 ea
5820*	20 oz Louis Tumbler	.63" x 11"	1008 ea
5822*	22 oz Louis Tumbler	.75" x 10.25"	1008 ea
5832*	32 oz Louis Tumbler	.75" x 12.63"	1008 ea
8004	Diablo Mug	1.5" x 5.5"	144 ea
8505	Rustic Mug	2" x 6.5"	144 ea
PCD796	Dredge (Base only)	2.5" x 5"	144 ea

*Decorating limited to one color.

Product List B

Lead Time – 6 weeks from approval of sample.
 Imprint Charge – \$0.50 net each piece, per side, per color.

Prod No	Description	Max Imprint H x W	Min Order Qty
5544	VersaPour Window Pitcher	2.75" x 2.75"	144 ea
5570*	Élan Pitcher	5" x 6"	144 ea
PS501N	Store 'N Pour Pint Complete	1.63" x 10.5"	180 ea
PS502N	Store 'N Pour Pint Backup	1.63" x 10.5"	180 ea
PS601N	Store 'N Pour Quart Complete	4.75" x 10.38"	180 ea
PS601NC	PourPlus Quart Complete	4.75" x 10.38"	180 ea
PS602N	Store 'N Pour Quart Backup	4.75" x 10.38"	180 ea
PS701B	Store 'N Pour Half Gallon Complete	4" x 14.5"	180 ea
PS702	Store 'N Pour Half Gallon Backup	4" x 14.5"	180 ea
PS801B	Store 'N Pour Gallon Complete	4.75" x 18"	180 ea
PS802	Store 'N Pour Gallon Backup	4.75" x 18"	180 ea

*Decorating limited to one color.

Product List C

Lead Time – 6 weeks from approval of sample.
 Imprint Charge – \$0.75 net each piece, per side, per color.

Prod No	Description	Max Imprint H x W	Min Order Qty
0200	PE 2 qt Bains Marie (below lugs)	2.75" x 3"	360 ea
0205	PPY 2 qt Bains Marie (below lugs)	2.75" x 3"	360 ea
0350	PE 3.5 qt Bains Marie (below lugs)	2" x 16"	360 ea
0355	PPY 3.5 qt Bains Marie (below lugs)	2" x 16"	360 ea
0600	PE 6 qt Bains Marie (below lugs)	5" x 3"	360 ea
0605	PPY 6 qt Bains Marie (below lugs)	5" x 3"	360 ea
0800	PE 8 qt Bains Marie (below lugs)	3.5" x 3.5"	360 ea
0805	PPY 8 qt Bains Marie (below lugs)	3.5" x 3.5"	360 ea
44030	Small Munchie Basket	1.38" x 2.25"	360 ea
44031	Large Munchie Basket	1.38" x 4.5"	360 ea

*Decorating limited to one color.

Product List D

Lead Time – 90 days from approval of sample.
 Imprint Charge – \$0.35 net each piece, per side, per color.

Prod No	Description	Max Imprint H x W	Min Order Qty
43141	Cup Size PC Measure	—	1200 ea
43142	Pint Size PC Measure	—	1200 ea
43143	Quart Size PC Measure	—	1200 ea
43144	Half Gallon Size PC Measure	—	1200 ea
43145	Gallon Size PC Measure	—	1200 ea

Call For Printing Specifications

DURUS® DECORATED DINNERWARE

All Durus items shown on pages 12-13 can be custom decorated.

Camera-Ready Artwork

- Digital artwork must be high resolution 300 dpi in an eps or tiff format. Artwork should be sent in the original format in which it was created. Artwork must also be properly separated when more than one color is used
- At customer's request, we will prepare camera-ready art at an artist fee of \$100.00/hour.
- Since the design possibilities are governed by the item to be decorated, details of all artwork must be submitted to Carlisle FoodService Products for consideration before an order can be accepted
- [Artwork colors must be darker than item to be decorated](#)

Samples

- With a firm order, we will provide ONE sample for approval before final production
- A NET charge of \$250.00 must be paid in advance to request one imprint sample without a firm purchase order. This charge also applies if your order is canceled after receipt of sample, prior to production

Minimum Quantities

- Minimum Custom Order – 1,008 per item

Case Lots

- All orders are sold in full case lots only

Lead Time

- 90-120 days upon approval of sample and date of order entry

Terms

- Delivery plus or minus 10% within the quantity ordered constitutes fulfillment of the order and payment shall be made on the basis of actual delivery

Returns

- [Custom decorated products are not accepted for exchange or refund](#)

Questions

- Contact your local Carlisle Sales Representative or your Customer Service Representative for more information



PERSONALIZED FIBERGLASS TRAYS

All fiberglass trays shown on pages 138-139 can be custom decorated.

Camera-Ready Artwork

- Any shape or size tray can be made in a custom color or personalized with your logo or artwork
- Digital artwork must be high resolution (300 DPI) as an EPS, PDF, TIFF, or JPG. Artwork should be sent in the original format in which it was created. Artwork must also be properly separated when more than one color is used
- Print area extends to .5" from the trays inside edges
- Artwork colors must be darker than the tray color.

Samples

- Carlisle must receive written sample approval from customer before order will be produced.
- Requests for more than one sample or for samples without a firm purchase order will be charged \$75.00 net

Minimum Quantities

- There is no print charge for minimum orders of 72 each & above
- There is a 144 piece minimum for custom colors

Case Lots

- Orders must be in full case pack quantity

Returns

- Custom colors and decorated products are not accepted for exchange or refund

Delivery

- Custom fiberglass trays ship from our Mexico facility in Chihuahua Mexico

Questions

- Contact your local Carlisle Sales Representative or your Customer Service Representative for more information



REPLACEMENT PARTS

Food Bars & Convenience

Prod No	Description	Pack	Cs Wt/ Cube
Maximizer Food Bar (pages 106-107)			
7749	Sneeze Guard End Shield	1 ea	42.70/16.60
7750	Sneeze Guard Side Shield	1 ea	42.70/16.60
7752	Post Knob	1 ea	0.20/0.04
7753	Shield Knob	1 ea	0.20/0.04
7754*	Basin Divider	1 ea	2.55/0.37
7760*	Sneeze Guard Post	1 ea	8.85/2.99
7761*	Sneeze Guard Cap	1 ea	5.85/2.33
7756	6 ft Shield Support Rod	1 ea	2.60/0.52
7755	Latch Assembly	1 ea	0.35/0.04
IC225CSB	5" Non-marking Swivel Caster with Brake	1 ea	2.15/0.12
Six Star & Five Star Food Bars (pages 108-109)			
6676	4 ft Side Shield (42.5"x 18.5") - catalog version, NSF approved	1 ea	10.63/3.15
6678	6 ft Side Shield (68.25"x 22.125") - catalog version, NSF approved	1 ea	15.25/1.85
6682	End Post Shields (20.75" x 8") - in catalog, NSF approved	1 ea	6.47/0.82
6684	Sneeze Guard Post	1 ea	7.50/2.65
6695	4 ft Ridge Channel	1 ea	3.20/0.13
6696	6 ft Ridge Channel	1 ea	5.15/0.21
6616*	Storage Kit for 6 ft Food Bar	1 ea	26.85/1.81
6602	4 ft Basin (Black only)	1 ea	55.00/13.98
6603*	6 ft Basin	1 ea	55.00/13.98
6686*	6 ft Door	1 ea	6.45/1.91
6687*	Standard Food Bar Leg	1 ea	11.25/4.17
6688*	Youth Food Bar Leg	1 ea	9.00/2.51
6693	Faucet Assembly	1 ea	0.60/0.05
IC225CR	5" Non-marking Caster Fixed	1 ea	2.15/0.12
IC225CSB	5" Non-marking Swivel Caster with Brake	1 ea	2.15/0.12
6697	Tray Slide Bracket - Chrome	1 ea	1.20/0.06
6705	Hardware for Leg/Basin	1 ea	0.60/0.05
6706	Hardware for Sneeze Guard Post	1 ea	0.30/0.05
6707	Hardware for Tray Slides	1 ea	0.30/0.05
6708	Hardware for End Shelf	1 ea	0.30/0.05
6709	Tabletop Drain Plug Assembly	1 ea	0.15/0.05
6672**	4 ft Six-Star Conversion Kit for 2011 NSF Standards	1 ea	25.20/3.15
6673**	6 ft Six-Star Conversion Kit for 2011 NSF Standards	1 ea	34.43/1.71
IC225CSB	5" Non-marking Swivel Caster with Brake	1 ea	2.15/0.12
6697	Tray Slide Bracket - Chrome	1 ea	1.20/0.06
6705	Hardware for Leg/Basin	1 ea	0.60/0.05
6706	Hardware for Sneeze Guard Post	1 ea	0.30/0.05
6707	Hardware for Tray Slides	1 ea	0.30/0.05
6708	Hardware for End Shelf	1 ea	0.30/0.05
6709	Tabletop Drain Plug Assembly	1 ea	0.15/0.05
6672**	4 ft Six-Star Conversion Kit for 2011 NSF Standards	1 ea	25.20/3.15
6673**	6 ft Six-Star Conversion Kit for 2011 NSF Standards	1 ea	34.43/1.71
6676	1 Side Only 44" Shield	1 ea	10.63/3.15

Prod No	Description	Pack	Cs Wt/ Cube
Sneeze Guard Acrylic Shields (page 110)			
9325	Shield - 24" (.19" Acrylic)	1 ea	7.70/1.78
9345	Shield - 48" (.19" Acrylic)	1 ea	14.75/3.00
9365	Shield - 60" (.19" Acrylic)	1 ea	19.80/4.34
9375	Shield - 73.38" (.19" Acrylic)	1 ea	22.30/4.50
Standard Sneeze Guards (page 110)			
9547*	1" Spar - 48"	1 ea	1.80/1.36
9561*	1" Spar - 60"	1 ea	2.60/0.46
9573*	1" Spar - 73.38"	1 ea	2.75/0.56
9848	Legs (only) - Standard-Single Sided	1 pr	3.40/0.98
9850	Legs (only) - Standard-Double Sided	1 pr	5.00/1.10
9645**	4 ft Ridge Channel	1 ea	2.16/0.36
9675**	6 ft Ridge Channel	1 ea	3.51/0.56
Adjustable Sneeze Guards (page 110)			
9648	1.25" Spar - 48" - Bottom - Adj.	1 ea	1.70/0.36
9660	1.25" Spar - 60" - Bottom - Adj.	1 ea	2.75/0.46
9672	1.25" Spar - 73.25" - Bottom - Adj.	1 ea	3.10/0.56
9948	Legs (only) - Adjustable-Single Sided	1 pr	7.00/0.94
9851	Legs (only) - Adjustable-Double Sided	1 pr	5.75/1.10
7702	Hardware for Single-Sided Sneeze Guard	1 ea	0.15/0.05
7704	Hardware for Two-Sided Tabletop Sneeze Guard	1 ea	0.15/0.05
Sneeze Guard Assembly Blocks (page 110)			
9001	Assembly Block - 1" 30° 2 Prong	1 pr	0.30/0.05
9005	Assembly Block - 1" 60° 3 Prong	1 pr	0.55/0.10
9002	Assembly Block - 1" 90° 3 Prong	1 pr	0.40/0.05
9003	Assembly Block - 1.25" 90° 3 Prong	1 pr	0.50/0.05
9004	Assembly Block - 1" 90° 2 Prong	1 pr	0.20/0.05
Electric Kettles (pages 25 & 111)			
0588C	Kettle Replacement Cord	1 ea	0.30/0.05
0588I	10.5 qt Insert	1 ea	2.13/1.14
0588L	Kettle Hinged Lid	1 ea	4.00/0.35
Crocks (pages 102-103)			
0311	Lid - 1.2/0.6 qt (fits 0300, 0301, 0341)	12 ea	0.60/0.09
0202	Lid - 1.5/2.7 qt (fits 0302, 0316, 0342, 0343)	12 ea	1.26/0.12
0602	Lid - 4 qt (fits 0304)	12 ea	2.00/0.21
7038	Gourmet Crock Replacement Lid	12 ea	1.30/0.22

*See product page referenced for color availability

*See product page referenced for color availability

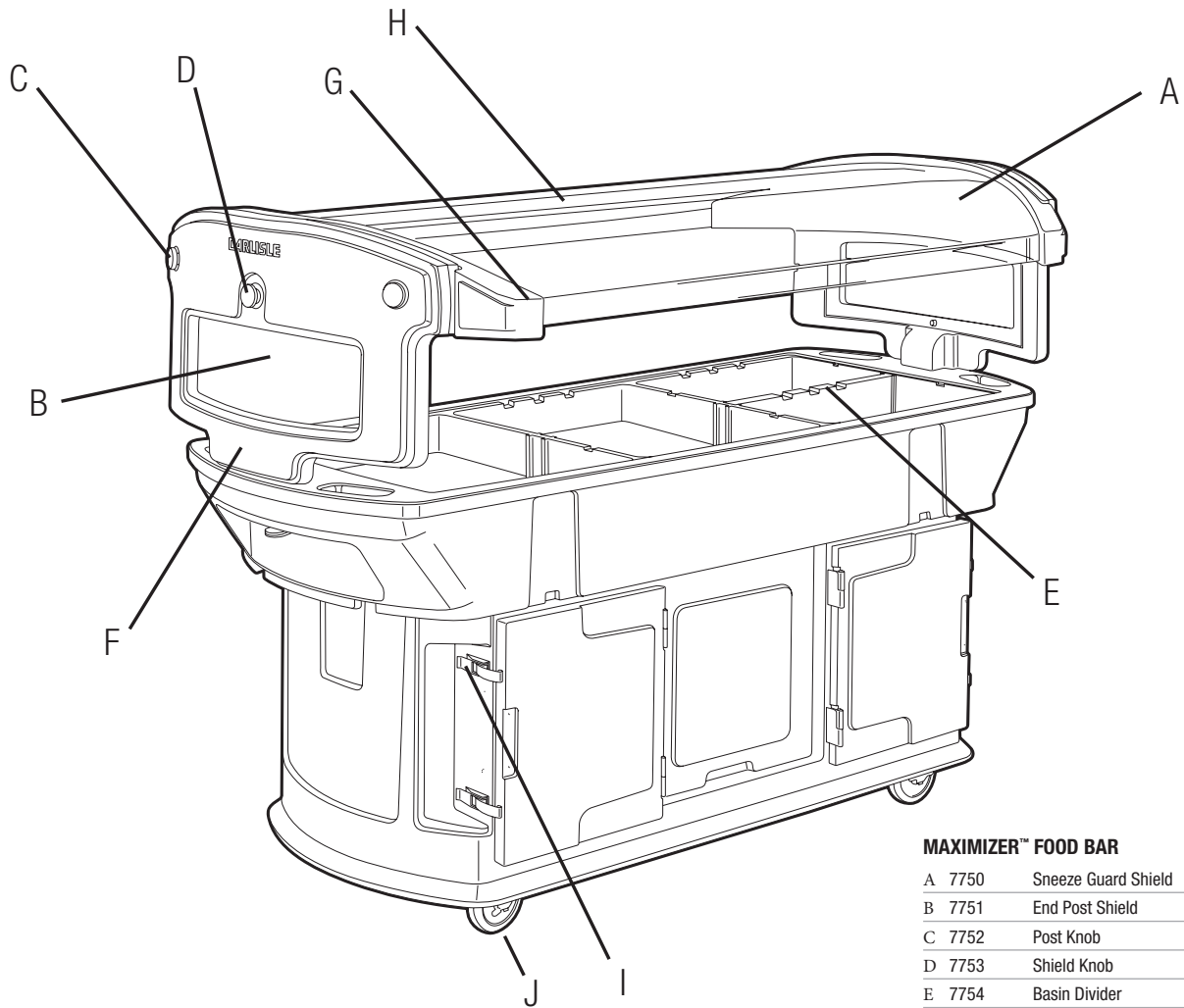

MAXIMIZER™ FOOD BAR

A	7750	Sneeze Guard Shield
B	7751	End Post Shield
C	7752	Post Knob
D	7753	Shield Knob
E	7754	Basin Divider
F	7760	Sneeze Guard Post
G	7761	Sneeze Guard Cap
H	7756	6 ft Shield Support Rod
I	7755	Latch Assembly
J	IC225CSB	5" Non-marking Swivel Caster with Brake



9005



9002



9003



9004



9001

REPLACEMENT PARTS

Food Bars & Convenience Cont

Prod No	Description	Pack	Cs Wt/ Cube
Cup & Lid Dispensers/Organizers (pages 114-115)			
38800MB	Quick Release Mounting Bracket	1 ea	0.20/0.01
38820CL	Lid for 38820 Small Cup Dispenser	1 ea	0.10/0.01
38830CL	Lid for 38830 Large Cup Dispenser	1 ea	0.12/0.01
38G850-SM	Small Release Gasket for Adjustable Drink Cup Dispensers	1 ea	0.25/0.02
38G850-MD	Medium Release Gasket for Adjustable Drink Cup Dispensers	1 ea	0.25/0.02
38G850-LG	Large Release Gasket for Adjustable Drink Cup Dispensers	1 ea	0.25/0.02
38G850-XLG	X-Large Release Gasket for Adjustable Drink Cup Dispensers	1 ea	0.25/0.02
38700P	Pint insert for 38800GLC Lid & Condiment Organizer	1 ea	1.20/0.16
38700Q	Quart insert for 38800GLC Lid & Condiment Organizer	1 ea	2.20/0.23
0311	Lid - 1.2/0.6 qt (fits 0300, 0301, 0341)	12 ea	0.60/0.09
0202	Lid - 1.5/2.7 qt (fits 0302, 0316, 0342, 0343)	12 ea	1.26/0.12
0602	Lid - 4 qt (fits 0304)	12 ea	2.00/0.21
7038	Gourmet Crock Replacement Lid	12 ea	1.30/0.22
Beverage Dispensers (page 116-117)			
10860*	Lid for PC & PPY TrimLine Dispensers	1 ea	1.04/0.35
10861*	Drip Tray for PC & PPY TrimLine Dispenser	1 ea	0.35/0.05
10864	PPY Translucent TrimLine Reservoir	1 ea	3.30/1.59
10865	PC Clear TrimLine Reservoir	1 ea	3.50/1.59
10866*	PC Single TrimLine Base	1 ea	3.60/1.45
10867*	PC Double TrimLine Base	1 ea	4.20/1.45
10868*	PPY Single TrimLine Base	1 ea	2.80/1.45
10869*	PPY Double TrimLine Base	1 ea	3.60/1.45
2213	Premium TrimLine Faucet	1 ea	0.50/0.05
2212	Economy Faucet (for use with TrimLine, Square, and Round Beverage Dispensers)	1 ea	0.47/0.05
1253	Lid for 3 gal & 5 gal Round Dispensers	1 ea	0.92/0.27
2210	5 gal Round (PE) Dispenser	1 ea	3.45/1.65
2209	5 gal Round (PPY) Dispenser	1 ea	3.45/1.65
2219	3 gal Round (PPY) Dispenser	1 ea	2.65/1.06
2211	Round (PE) Dispenser Base	1 ea	2.25/0.70
Stainless Steel Dispensers (page 113)			
38132	SS & Acrylic Hinged Lid for Fountain Jars	1 ea	0.30/0.02
38550R	SS Pump with Dip Tube & 2 Sparta Pump Brushes	1 ea	2.00/0.10
38508	2.5 qt Fountain Jar	1 ea	1.00/0.25
38600CL	Standard 2 qt Storage Container with SS Cover and No Pump	1 ea	0.10/0.14
38600IP	Freezable Large Ice Pack	1 ea	2.15/0.05
386010C	SS Cover for 386010 (for use with SS Pump)	1 ea	0.65/0.02
386020C	SS Cover for 386230IB (for use with SS Pump)	1 ea	0.65/0.02
38623INS	Insulation Panel Set for Insulated Dispensers	1 set	0.50/0.01
38550CAP	Plunger Cap for SS Pump 38550R	1 ea	0.02/0.01
38550CL-1	.5 oz Restrictor Clip for SS Pump 38550R	1 ea	0.01/0.01
38550CL-2	1 oz Restrictor Clip for SS Pump 38550R	1 ea	0.01/0.01
38550COR	Cylinder O-Ring for SS Pump 38550R	1 ea	0.01/0.01

Prod No	Description	Pack	Cs Wt/ Cube
Stainless Steel Dispensers cont. (Page 113)			
38550GB	Rubber Spout Grommet for use with all SS Pump(38550R) Covers	1 ea	0.01/0.01
38550SC	Stainless Wire Spout Clip for SS Pump 38550R	1 ea	0.01/0.01
38550SOR	Spout O-Ring for SS Pump 38550R	1 ea	0.01/0.01
38559CSB	SS Ball Cock for SS Pump 38550R	1 ea	0.01/0.01
38550PSO	Piston Seal & O-Ring for SS Pump 38550R	1 ea	0.10/0.01
38550SPR	SS Spring for SS Pump 38550R	1 ea	0.05/0.01
40155	15" Spout Brush (.5" dia) for SS Pump 38550R	12 ea	0.46/0.11
40156	10.5" Plunger Brush (1.5" dia) for SS Pump 38550R	12 ea	0.85/0.11
Fixed Dispensers (page 113)			
38601C	SS Cover for High Volume Dispensers using Fixed Pump 38600R	1 ea	0.65/0.02
38600R	Fixed Nozzle Pump with Trim-to-Fit Dip Tube	1 ea	0.45/0.13
38610120P	Set Pump & Lise (120mm) with 9" dip tube	1 ea	0.55/0.13
3861089P	Fixed Nozzle Pump & 89mm Lid with 9" Dip Tube (fits Store 'N Pour)	1 ea	0.50/0.13
38600DT-11	11" Trim-to-Fit Dip Tube for Fixed Pump 38600R	1 ea	0.75/0.07
Standard Dispensers (page 113)			
3831089P	Standard Pump & 89mm Lid with 5" Dip Tube (fits Store 'N Pour)	12 ea	0.45/0.05
CM1035	Standard Pump Only	2 ea	0.75/0.27
38620C	SS Dispenser Cover for use with Standard Pump CM1035	1 ea	1.00/0.01
38600IP	Freezable Large Ice Pack	1 ea	20.15/0.05
38508	2.5 qt Fountain Jar	1 ea	1.00/0.25
38623INS	Insulation Panel Set for Insulated Dispensers	1 set	0.50/0.01
38600CL	Standard 2 qt Storage Container with SS Cover and No Pump	1 ea	0.10/0.14
Maxi Pumps (page 100)			
CM1037	1 oz Maxi Pump with 2 sizes of Nozzle Restrictors	2 ea	1.00/0.27
38400RSS	Spring for Maxi Pump CM1037	1 ea	0.05/0.01
Pump Kits (page 112)			
3831038	Cap Only, 38mm	12 ea	0.10/0.01
3831063	Cap Only, 63mm for Oil/Shortening Containers	12 ea	0.45/0.16
3831089	Cap Only, 89mm	12 ea	0.45/0.05
38310110	Cap Only, 110mm	12 ea	0.70/0.09
38310110S	Cap Only, 110mm Snap-Fit Cap	12 ea	1.10/0.09
38310120	Cap Only, 120mm	12 ea	0.85/0.12
38310160	Cap Only, 160mm Snap-Fit Cap for #10 Cans	1 ea	0.35/0.13
Packet Racks (page 112)			
381101LG	3.5 qt Container for 381106 & 381109	12 ea	10.00/2.41
381201LG	4 qt Container for 381206LG	12 ea	6.35/1.01
Classic™ Crock Condiment Station (page 103)			
0302*	2.7 qt Classic™ Crock with Lid	6 ea	7.10/1.25
0204	2.7 qt Lid with Hole for Pump	12 ea	1.26/0.12

*See product page referenced for color availability
 Shipping Note: 6616, 667, 6679 can ship UPS/FedEx Ground at oversize cost
Five Star Food Bar Owners: For replacement and upgrade parts, contact your Carlisle Customer Service Representative

*See product page referenced for color availability

Catering Equipment

Prod No	Description	Pack	Cs Wt/ Cube
Cateraides (pages 154-163)			
IT410CSB	5" Swivel Caster w/Brake	1 ea	2.15/0.12
IT410CS	5" Swivel Caster	1 ea	2.15/0.12
IT2550LA*	Beverage Server Latch Assembly (IT250, IT500)	1 ea	0.07/0.01
IT1000LA*	Beverage Server Latch Assembly (IT1000)	1 ea	0.07/0.01
IT141618LA*	Top Loader Latch Assembly (IT140, IT160, IT180)	1 ea	0.07/0.01
IT400LA*	End Loader Latch Assembly (IT400)	1 ea	0.07/0.01
IT2550GA	Gasket (IT250, IT500)	1 ea	0.50/0.05
IT1000GA	Gasket (IT1000)	1 ea	0.50/0.05
IT2550VC*	Vent Cap Assembly (IT250, IT500)	12 ea	0.15/0.05
IT1000VC*	Vent Cap Assembly (IT1000)	12 ea	0.15/0.05
IT400HA	Hinge Assembly (IT400)	1 ea	0.45/0.05
XT2550*	Lid Assembly (XT2500, XT5000)	1 ea	2.54/0.56
XT1468L*	Lid Assembly (XT1400, XCT1600, XT1800)	1 ea	4.70/1.09
XT10001LG*	Lid Assembly (XT10000)	1 ea	4.70/5.67
XT10001GA	Gasket (XT10000) - White	1 ea	2.54/0.56
XT12FLRF	Gasket (XT10000) - Black	1 ea	2.54/0.56
XT2550LA	Latch Assembly with Screws (XT2500, XT5000, XT10000)	1 ea	0.50/0.05
XT2550GA	O-Ring Gasket (XT2500, XT5000)	1 ea	0.25/0.05
XB35GA	Gasket (XB5, XB3)	1 ea	0.25/0.05
XB35LG	Lid Assembly (XB5, XB3)	1 ea	4.07/0.56
LD111VC	White Vent Cap (LD and XT Beverage Servers)	1 ea	0.15/0.05
LD112VC	White/Black Vent Cap (LD and XT Beverage Servers)	1 ea	0.15/0.05
LD222NLA	Nylex Latch Assembly (LD Beverage Servers, PC Pan Carriers and Ice Caddies)	1 ea	0.05/0.01
LD222LA	Latch Assembly (LD Beverage Servers)	1 ea	0.07/0.01
LD333FA	Faucet Assembly	1 ea	0.50/0.05
IC225FD	Faucet Drain Assembly (IC220, IC2250, IC2250T, IC2254)	1 ea	2.00/0.38
LD236LG*	Lid Assembly (LD250N)	1 ea	2.00/0.35

*See product page referenced for color availability

Prod No	Description	Pack	Cs Wt/ Cube
Cateraides cont. (pages 154-163)			
LD235LG*	Lid Assembly (LD350N, LD500N)	1 ea	2.00/0.46
LD1001LG*	Lid Assembly (LD1000N)	1 ea	4.70/1.14
PC146LG*	Lid Assembly (PC140N, PC160N, PC188N)	1 ea	5.00/1.09
PC181LG*	Lid Assembly (PC180N)	1 ea	5.30/1.41
PC301LG*	Door Assembly (PC300N, PC600N)	1 ea	5.50/1.46
IC225LH*	Lid Assembly (IC2250, IC2250T, IC2254)	1 ea	9.10/1.34
PC146GA	Gasket (PC140N, PC160N, PC188N, PC200N)	1 ea	0.50/0.05
PC181GA	Gasket (PC180N)	1 ea	0.50/0.05
PC301GA	Gasket (PC300N, PC600N)	1 ea	0.50/0.05
LD235GA	Gasket (LD250N, LD350N, LD500N)	1 ea	0.25/0.05
TC1826GA	Gasket (TC1826N)	1 ea	0.45/0.05
LD1001GA	Gasket (LD1000N)	1 ea	0.45/0.05
LD501BD	6 Imprinted Beverage Decals	1 ea	0.15/0.05
PC301HA	Hinge Assembly (PC200N, PC300N, PC600N, TC1826N)	1 ea	0.45/0.05
IC222LH	Lid Assembly (IC2220)	1 ea	10.20/1.59
IC2250HA	Hinge Assembly (IC2250, IC2250T, IC2254)	1 ea	0.45/0.05
IC222WH	10" Non-Marking Wheel (IC2220)	1 ea	3.30/0.28
IC225WH	8" Non-Marking Wheel (IC2250T)	1 ea	2.30/0.21
IC225CR	5" Rigid Non-Marking Caster (IC2250, IC2254)	1 ea	2.15/0.12
IC2254CS	5" Swivel Non-Marking Caster (IC2220, IC2250, IC2250T, IC2254)	1 ea	2.15/0.12
IC225CSB	5" Swivel Non-Marking Caster with Brake (IC2220, IC2250, IC2250T, IC2254)	1 ea	2.15/0.12
C2222C	4" Swivel Non-Marking Caster (DL300, DL1826)	1 ea	2.70/0.21
IC2220HA	Ice Caddy Hinge Assembly With Stake	1 ea	0.45/0.05
IC2224HA	Ice Caddy Hinge (IC2220)	1 ea	0.45/0.05
IC2250S	Ice Caddy Shelf (IC2250, IC2250T, IC2254)	1 ea	4.80/0.65

REPLACEMENT PARTS

Bar Supplies

Prod No	Description	Pack	Cs Wt/ Cube
Maximizer Portable Bar (pages 120-121)			
7551*	Front Replacement Bar Panel	1 ea	15.08/1.02
7552*	Side Replacement Bar Panel	1 ea	7.04/0.69
7547	Bar Top Replacement	1 ea	122.00/5.64
7549	Bar Cutting Board Replacement	1 ea	3.57/0.50
7543	Bar Stanchion Replacement	1 ea	14.53/0.22
7546	Bar Drain Assembly Replacement	1 ea	0.15/0.05
7545	Dust Cover for Ice Bin	1 ea	14.53/0.84
7548	Speed Rail	1 ea	5.00/1.33
1568	8 qt Waste Bucket	12 ea	14.72/2.05
IC2254CS	5" Swivel Caster Wheel without Brake	1 ea	2.15/0.12
IC225CSB	5" Swivel Caster Wheel with Brake	1 ea	2.15/0.12
Store 'N Pour (pages 122-123)			
PS103	Spouts, Specify Color	12 ea	0.45/0.05
PS103AT	Spout Assortment, 2 ea Color	12 ea	1.00/0.05
PS304	Caps, Specify Color	12 ea	0.70/0.10
PS304AT	Caps, Assortment, 2 ea Color	12 ea	0.70/0.10
PS203	Necks	12 ea	1.60/0.30
PS603N	Quart, Container Only	12 ea	3.00/0.85
Deluxe Condiment Caddy system (page 125)			
CHI4	Replacement 1.5 Pt Containers, White	16 ea	2.00/0.77
CHI6	Replacement Pint Containers, White	24 ea	1.99/0.61
SS107	Replacement 1.25 Pt Containers/Lid, White	12 ea	3.16/0.50
Stainless Steel Iced Condiment Caddies (page 125)			
38700IP	Small Freezable Ice Pack	1 ea	0.55/0.04
38700P	Pint Insert, Plastic	12 ea	1.20/0.16
38700Q	Quart Insert, Plastic	12 ea	2.20/0.23
Glass Rimmers (page 128)			
GR09RS	5.5" D Sponges for 3-Tier Unit	12 ea	0.45/0.15

*See product page referenced for color availability

Foodservice Trays

Prod No	Description	Pack	Cs Wt/ Cube
Cork Trays (page 147)			
3054	Cork for 14" Round	12 ea	2.22/0.037
3056	Cork for 16" Round	12 ea	2.69/0.37
3019	Cork for 19" x 24" Oval	12 ea	4.56/0.93
3023	Cork for 23" x 28" Oval	12 ea	7.82/1.29

Professional Cookware

Prod No	Description	Pack	Cs Wt/ Cube
Dura-Kool Sleeves (pages 166-169)			
60RS-1	4.25" x .75" Dura-Kool Sleeve (fits 7", 8" Fry Pans and Small Pots & Pans)	12 ea	1.00/0.12
60RS-2	5.13" x .75" Dura-Kool Sleeve (fits 10"-12" Fry Pans and Medium Pots & Pans)	12 ea	1.50/0.13
60RS-3	6.13" x 1" Dura-Kool Sleeve (fits 14" Fry Pans and Large Pots & Pans)	12 ea	2.00/0.17

Waste Management

Prod No	Description	Pack	Cs Wt/ Cube
Waste Containers (page 311)			
3672231	3" Caster for Dolly	1 ea	1.00/0.00
Tilt Trucks (page 320-321)			
WH40000	Wheel 400 lb	1 ea	6.50/0.78
WH82500	Wheel 825 lb	1 ea	13.25/0.78
WH120000	Wheel 1200 lb	1 ea	19.25/0.78
IC2254CS00	Casters	1 ea	2.15/0.12



Kitchen Accessories

Prod No	Description	Pack	Cs Wt/ Cube
Heat Lamps Options & Accessories (pages 180-181)			
HLRP5	Standard Socket (Heat Lamp HL7237)	1 ea	0.30/0.05
HLRP11	Flex Socket (Heat Lamp HL8185 & HL8195)	1 ea	0.35/0.05
LRP20	24" Flex Arm (Heat Lamp HL8185)	1 ea	2.03/0.25
601825	18" x 26" Bun Pan (use with HL8) (use with 8100 & 8200 Series Lamps)	12 ea	39.00/1.59
HLA8	16" x 24" Maple Board (use with 8100 & 8200 Series Lamps)	1 ea	18.00/1.19
HLA20	Flexiglow Clamp (use with 8100 & 8200 Series Lamps)	1 ea	1.70/0.22
HLRP999	Ceramic Insulator (Heat Lamp HL7237)	1 ea	0.20/0.05
607002	Food Service Pan (HL7237)	6 ea	15.00/1.03
HLRP6	250 Watt White Bulb in Clear(07)	1 ea	0.60/0.26
HLRP7	250 Watt Red Bulb in Red(05)	1 ea	0.60/0.26
Order Wheels (page 182)			
381CH	Mounting Plate, Ceiling Hung	1 ea	0.25/0.01
382WH	12" Wall Hung Extension & Plate	1 ea	1.00/0.03
383CM	9" Counter Mount Extension & Plate	1 ea	0.90/0.28
384MP99	9" Movable Base Extension	1 ea	0.55/0.01
381SC-OW	Ball & Spring Clip Assembly	12 ea	0.25/0.05
381EX	Extension (for CM, MP, CH, or WH Models) Specify length & type with maximum 24" length	1 ea	0.55/0.00
Spatulas & Paddles (pages 196-197)			
40361	4.5" x 7" Standard Nylon Replacement Blade	6 ea	1.50/0.10
40362	6.5" x 9" Large Nylon Replacement Blade	6 ea	2.65/0.16

Storage & Handling

Prod No	Description	Pack	Cs Wt/ Cube
Ingredient Bins (page 219)			
BIN27L	Replacement lid for BIN27	1 ea	4.50/0.64
BIN36L	Replacement lid for BIN36	1 ea	5.65/0.64
BIN44L	Replacement lid for BIN44	1 ea	5.85/0.64

Warewashing

Prod No	Description	Pack	Cs Wt/ Cube
E-Z Glide Rack Dollies (page 233)			
C2237	Handle for C2236H	1 ea	5.80/1.21
C2222C	Replacement Caster for C2220A & C2222A	1 ea	2.70/0.21
C2222HD	Handle for C2220A & C2222A	1 ea	7.00/3.37

Tabletop

Prod No	Description	Pack	Cs Wt/ Cube
Tortilla Servers (pages 56-57)			
0700*	7" Hinged Replacement Lid (0710)	12 ea	3.51/0.27
0703*	8" Replacement Lid (0713)	12 ea	7.00/0.44
0707*	12" Replacement Lid (0717)	6 ea	8.00/0.51
Dual Booster Seat (page 59)			
7112	Replacement Strap	12 ea	2.00/0.43

*See product page referenced for color availability

Transportation

Prod No	Description	Pack	Cs Wt/ Cube
Bussing Carts (page 301)			
CCSTR2036	4" Stem Caster for CC2036, CC2243	1 ea	1.10/0.05
Fold 'N Go Carts (page 300)			
SBCC240	Replacement Caster, Swivel	1 ea	2.15/0.12
SBCC245	Replacement Caster, Swivel with Brake	1 ea	2.15/0.12
Service Cart (page 302)			
IC225CSB	5" Swivel Caster with Brake	1 ea	2.15/0.12
IC2254CS	5" Swivel Caster	1 ea	2.15/0.12
IC225CR	5" Rigid Caster	1 ea	2.15/0.12
Optimizer Dish Dollies (pages 304-305)			
ADDD	ADD4, ADD6 Dividers	2 ea	4.70/0.47
ADSD	ADS4, ADS8 Dividers	4 ea	10.00/1.02
ADDC	ADD4, ADD6 Vinyl Cover	1 ea	2.10/0.31
ADSC	ADS4, ADS8 Vinyl Cover	1 ea	2.10/0.31
IC222WH	10" Wheel for ADD4, ADD6	1 ea	3.30/0.28
IC225CSB	5" Swivel Caster with Brake for All Models	1 ea	2.15/0.12
IC225CR	5" Fixed Casters for ADS4, ADS8	1 ea	2.15/0.12
ADDA	Axle for ADD4, ADD6	1 ea	1.80/0.22

DURUS® WARRANTY & CARE

Durus Dinnerware 4 Year Limited Warranty

Durus Dinnerware is shown on pages 12-13. Durus must be handled like any fine dinnerware. Carlisle FoodService Products agrees to extend a limited four year Warranty against breakage on its Durus line of dinnerware provided that the following procedures for care are observed:

- Do not use steel wool, harsh abrasive pads, abrasives, or scouring compounds, chlorine bleach, or chlorine based solutions in the washing process of this dinnerware. Do not intentionally strike or bang against counters or hard objects to remove debris. All debris should be removed by hand using a nylon or silicone plate scraper, sponge, or soft bristle brush. Do not place Durus dinnerware in a standard oven or microwave oven. Do not expose Durus to direct flame or dry heat over 180°F.
- Upon receipt of your shipment, complete one Warranty Card enclosed with your purchase. If this card is not completely filled out and forwarded to Carlisle FoodService Products, the Warranty is null and void.
- This Warranty herein extends only to the original user (purchaser), and is not assignable, or transferable, and shall not apply to any parts which have been subject to alteration, misuse, negligence, or accident. This Warranty does not cover chipping or staining of the product.
- Should any breakage occur during the limited Warranty, which commences on the date of delivery or receipt, please contact Carlisle's Customer Service Department at 800.654.8210 for return authorization and shipping instructions.

In light of the express four (4) year Limited Warranty provided by Carlisle FoodService Products, the duration of any implied warranties, including any implied warranties of the merchantability of fitness for a particular purpose, is hereby limited in all respects to the period covered for the express Warranty. Except for its Warranty obligations, Carlisle FoodService Products shall not be liable to the purchaser or to any other person, to the maximum extent permitted by law, for any loss or damages of any kind, including but not limited to, incidental, special, or consequential damages or loss of profits, arising out of or in connection with the use, loss of use, or replacement of the warranted products. Misuse, abuse, negligence, or failure to follow the Durus care and use instructions will render this warranty null and void.

How to Care for your Durus Dinnerware

- Do handle Durus like any fine dinnerware.
- Use only non-abrasive cleaning pads that do not contain any mineral grit as this will scratch the melamine surface, or use any Carlisle plastic bristled brush to remove dried-on food.
- Do pre-soak Durus, if desired with a non-chlorinated pre-soak.
- Do remove hard water film, food residue, and dried-on stains using a simple paste made from an oxygenating or alkaline pre-soak powder according to detergent manufacturer's directions.
- Do wash Durus in a good quality, non-chlorinated, highly alkaline dishwashing compound.
- Do not place Durus in a microwave oven.
- Do not place Durus in a conventional oven.
- Do not expose Durus to direct flame or dry heat over 180°F.
- Do not use harsh abrasive cleaner, steel wool, or metal scouring pads.
- Do not use chlorine bleach or chlorine based cleaning/sanitizing solutions.
- Do not overload dishwasher racks.
- Do not strike or bang Durus to remove food debris.



PRODUCT INDEX

Prod No	Page No	Prod No	Page No	Prod No	Page No	Prod No	Page No
0120	35	10200B	206	10476U	207	10771	214
0132	35	10201B	206	10477U	207	10772	214
0200	215, 325	10202B	206	10490U	207	10773	214
0202	102, 103, 215, 330	10203B	206	10491U	207	10806	112
0203	215	10210U	206	10496U	207	10807	112
0204	331	10211U	206	10497U	207	10820	117
0205	215, 325	10212B	206, 207	10510U	207	10828	115
0240	105, 324	10215	206	10511U	207	10850	116
0261	105	10216U	206	10516U	207	10851	116
0287	105	10217U	206	10517U	207	10852	116
0295	105, 324	10220B	206	10535	207	10853	116
0296	105, 324	10221B	206	10536U	207	10854	116
0300	102	10222B	206	10537U	207	10856	116
0301	102, 324	10223B	206	10601	127	10857	116
0302	102, 324, 331	10230U	206	10602	127	10860	330
0304	102, 324	10231U	206	10610	210	10861	330
0306	103	10232B	206, 207	10611	210	10864	330
0311	102, 330, 330	10235	206	10612	210	10865	330
0316	102, 324	10236U	206	10617	210	10866	330
0333	55	10237U	206	10620	210	10867	330
0338	51	10240B	206	10621	210	10868	330
0340	83	10241B	206	10622	210	10869	330
0341	102	10250U	206	10623	210	10880	179
0342	102	10256U	206	10624	210	10881	179
0343	102	10257U	206	10627	210	10882	179
0344	83	10270U	206	10628	210	10883	179
0345	22	10271U	206	10629	210	10884	179
0347	22	10276U	206	10630	211	10885	179
0350	215, 325	10277U	206	10631	211	10886	179
0355	215, 325	10290U	206	10632	211	10887	179
0362	51	10291U	206	10637	211	10888	179
0365	103, 324	10296U	206	10640	211	10889WC	179
0372	103, 324	10297U	206	10641	211	10897	179
0386	237	10302FMT	140	10642	211	10901	179
0411	77	1030FMT	140	10643	211	1100GL	147
0470	56	10310U	206	10644	211	1100GR	146
0475	56	10311U	206	10647	211	11020	93
0588	25, 111	10316U	206	10648	211	11026	93
0588C	330	10317U	206	1071	237	11030	93
0588I	330	10335	206	10720	212	11036	93
0588L	330	10336U	206	10721	212	1104	35
0600	215, 325	10400B	207	10722	212	1105	35
0602	102, 215, 330	10401B	207	10723	212	1108	35
0603	215	10402B	207	10724	212	1110	35
0605	215, 325	10410U	207	10725	212	1110L	45
0700	57, 328	10411U	207	10726	212	1112	35
0703	57, 328	10415	207	10730	212	1112L	45
0707	57, 328	10416U	207	10731	212	1116	35
0710	57	10417U	207	10732	212	11789	179
0713	57	10420B	207	10733	212	11799	179
0717	57	10421B	207	10734	212	11801	179
0800	215, 325	10422B	207	10735	212	11828	257
0805	215, 325	10423B	207	10736	212	11829	257
0820	51	10430U	207	10740	212	11830	257
0830	51	10431U	207	10741	212	11831	257
0831	51	10435	207	10742	212	11832	257
0843	51	10436U	207	10761	214	11833	257
0844	51	10437U	207	10763	214	11879	179
0845	51	10440B	207	10764	214	1200	215
0855	49	10441B	207	10765	214	1202	215
0860	48	10450U	207	10766	214	1205	215
0862	48	10456U	207	10767	214	1212FG	139
0864	49	10457U	207	10768	214	1216LFG	139
1000B	75	10470U	207	10769	214	1217BT	141, 323
10145	144	10471U	207	10770	214	1218FMT	140

PRODUCT INDEX

Prod No	Page No	Prod No	Page No	Prod No	Page No	Prod No	Page No
1219LFG	139	2216FGQ	139	30886	207	341056	310
1220FG	139	2216GRQ	146	30887	207	341057	310
1222LFG	139	2219	117, 330	30888	207	341132	310
1230FMT	140	2227	117	30895	207	341144	310
1250B	75	2229	117	30896	207	341528	312
1252	215	2230	117	3100GR	146	341529	312
1253	330	2310FG	139	3210	127	341540	312
12875	183	2419	147	3211	127	341541	312
12876	183	2500	51	3253GR	146	341542	312
12877	183	2500GR	146	33000	10	342015	315
12881	179	2512	87	33002	10	342015REC	319
12882	179	2618FGQ	139	33004	10	342023	315, 323
12886	179	2618FMTQ	140	33006	10	342023CMP	319
12887	179	2637FG	139	33008	10	342023REC	319
12891	179	269FG	139	33010	10	342024	315
12892	179	269FMT	140	33012	10	342025	315, 319
12901	179	2700GR	146	33016	10	342026REC	319
1300	58	2710	219	33018	10	342027REC	319
1318FG	139	2823	147	33020	10	342913	317
1318FMT	140	3004	87	33024	10	342913REC	319
1319BT	141, 323	3013	147	33030	11	342915	317
1400GL	147	3014	147	33032	11	342927	317
1400GR	146	3015	147	33034	11	342928	317
1410FG	139	3016	147	33036	11	342928REC	319
1410GR	146	3019	332	33038	11	342940	317
1418LFG	139	3023	332	33040	11	342941	317
1418PC	140	3042	122, 123	33042	11	342941REC	319
1419FG	139	3054	332	33080	11	343021	314
1520LFG	139	3056	332	33082	11	343021REC	318
1532	213	30580	206, 207	33086	11	343022	314, 318
1544	213	30581	206, 207	3312	52	343122	314
1556	213	30582	206, 207	3316	52	343123	314
1568	213, 332	30583	206, 207	3319	52	343124	314
1600GL	147	30660	206	33302	70	343523	314
1600GR	146	30661	206	33310	70	343523REC	318
1612FG	139	30662	206	33312	70	343525	314
1612GR	146	30669	206	33314	70	343526REC	318
1629	213	30670	206	33316	70	343527REC	318
1713FG	139	30680	206	33318	70	343935	314
1800	215	30681	206	33320	70	343935REC	318
1805	215	30682	206	33322	70	343936REC	318
1814FG	139	30683	206	33324	70	343937REC	318
1814GR	146	30684	206	33326	70	343950	314
1826FG	139	30685	206	33360	69	343950REC	318
1826GRQ	146	30686	206	33362	69	343951	314
1900	26	30687	206	33364	69	344042	313
1960	26	30688	206	339	83	344056	313
1965	26	30689	206	341010	310, 323	344056REC	319
1987	26	30695	206	341010ICE	183, 311	344057	313
1989	26	30860	207	341011	183, 310	344057REC	319
1991	26	30860H	209	341020	310, 323	344058	313
1992	26	30860HH	209	341020REC	318	345050	313, 323
1993	26	30861	207	341021	310	345050REC	319
1994	26	30861H	209	341021REC	318	346144	316
2015FG	139	30861HH	209	341032	310, 323	346145	316
2015GR	146	30862	207	341032REC	318	346146	316
2115FG	139	30869	207	341033	310	34RECLBL	318, 319
2200	215	30870	207	341033REC	318	356	55
2205	215	30871	209	341034	310	3610140	251
2209	117, 330	30880	207	341035	310	361410	269
2210	117, 330	30881	207	341044	310, 323	36141003-1	269
2211	330	30882	207	341044REC	318	361412	268
2212	330	30883	207	341045	310	361415	268
2213	330	30884	207	341045REC	318	361416	268
2214FG	139	30885	207	341055	310, 323	36142003	269

Prod No	Page No	Prod No	Page No	Prod No	Page No	Prod No	Page No
361437	269	365320	271, 296	369424B	284	3831063	331
36175	270, 296	365351	271	369425B	284	3831089	331
36190	270, 296	365408	277	369430	284	3831089P	331
36192	270, 296	365450	258	36944	291	38322BH	124
36193	270, 296	365501	251	369442B	284	38332BH	124
36197	270, 296	36552	249	369448B	284	38342BH	124
362013	278	36567	274, 297	36945	291	38360	182
3620194	262, 263, 277	36568	274, 297	369454B	284	38360A	182
3620294	262, 263, 277	36592	275	369460	284	383CM	333
36204818	266, 296	36596	275	36947	291	38400RSS	331
36204824	266, 296	366318	272, 297	369472B	284	38480	182
36207218	267, 296	366324	272, 297	369475	288	38480A	182
36207224	267, 296	36633	264	369478B	284	384MP99	333
36211	259	366330	272, 297	369484B	284	38502	113
362113	278	366824	272, 297	36949	291	38503	113
36219618	265	366918	273	369520	285	38504	113
36219624	265	366922	273	369550B	284	38508	331
36219663	271	3672231	311	369551B	284	38550CAP	331
362208P18	266, 296	36752	251	369552B	284	38550CL-1	331
362208P24	266, 296	36753	251	369595	289	38550CL-2	331
36232	295	367600TC	251	369670B	286	38550COR	331
36233	295	367618	267, 296	369674B	286	38550GB	331
36236	269	367624	267, 296	36968	289	38550PSO	331
36239	256	367814	273, 297	36970	288	38550R	331
36275	270, 296	367818	273, 297	369724	287	38550SC	331
36289	252	3682	264	369732	287	38550SOR	331
36292	270, 296	36853	263	369811B	286	38550SPR	331
363156	258	36854	263	369814B	286	38559CSB	331
36324C	274	36859	263, 296	369816B	286	38600CL	331, 331
3633	295	36860	263, 296	369817B	286	38600DT-11	331
3633019	281	36861	262	369819B	286	38600IP	331
3633118	280	36863	263, 296	369820B	286	38600R	100, 331
3633124	280	36864	263, 296	369824B	286	38601	113
3633136	280	36865	262	369832	286	386010	113
3633218	280	36867	262	36990	288	386010C	331
3633224	280	36868	262	36990R	288	38601C	331
36333	257	36873	263	36P5	295	386020C	331
36334	257	36874	263	3753FG	139	38610120P	331
3633519	280	36883	263, 296	381101LG	331	3861089P	331
3633525	280	36884	263, 296	381109LG	112	38620C	331
3633537	280	36885	241, 262	381201LG	331	386230IB	113
3633670	280	36900	291	381206LG	112	38623IB	113
36336C	274	369024C	287	3812CH	182	38623INS	331
363404	258	369024R	287	3812CM	182	38655	21, 100
363725	254	36904	290	3812MP	182	38700IP	332
36396	251	36905	290	38132	331	38700P	330, 332
36399	269	36908	290	3816	199	38700Q	330, 332
36400	269	36908C	290, 307	3816CH	182	38704C	125
364105	278	36908W	290	3816MP	182	38704CNS	125
36439	295	36909	291	3816WH	182	38704CSIB	125
3647248	281	36910	311	3817	199	38705C	125
3647524	281	36911	311	38180A	182	38706C	125
3647536	281	36917	311	381CH	333	38800GLC	115
3647548	281	36920-1	315	381EX	333	38800MB	330
36490	281	369320	285	381SC-OW	333	38820C	114
36490R	281	369365	289	3820CH	182	38820CL	330
365015	246	369375	289	3820MP	182	38830C	114
36505	246	36940	291	38240A	182	38830CL	330
36505L	246	36941	291	382WH	333	38850GEW	114
36506	246	369412B	284	38310	112	388804L	115
36506L	246	369413B	284	38310110	331	38882G	114
365117	258	369418B	284	38310110S	331	38883G	114
365120	258	369419B	284	38310120	331	38884G	114
365300	271, 296	36942	291	38310160	331	38G850-LG	330
365310	271, 296	369420	285	3831038	331	38G850-MD	330

PRODUCT INDEX

Prod No	Page No	Prod No	Page No	Prod No	Page No	Prod No	Page No
38G850-SM.....	330	40146.....	241, 294, 297	40380.....	184	40728.....	253
38G850-XLG.....	330	40147.....	294, 297	40390.....	186	40729.....	253
3956.....	191	40148.....	294, 297	40391.....	186	40731.....	279
3957.....	191	40150.....	247	40392.....	186	40732.....	279
3958.....	191	40152.....	247	40393.....	186	40733.....	279
3959.....	191	40153.....	249	40394.....	186	40735.....	279
3960.....	191	40154.....	249	40395.....	185	40737.....	279
3961.....	191	40155.....	249, 331	40396.....	185	410.....	48
3970.....	191	40156.....	249, 331	40397.....	185	41020.....	276, 277
3971.....	191	40157.....	249	40398.....	185	41027.....	258, 259
3980.....	191	4016.....	35	40399.....	185	41076-1.....	199
3981.....	191	40164.....	187, 241	40400.....	185	41077-1.....	199
3990.....	191	40180.....	249	40401.....	185, 241	41082.....	262
3991.....	191	4020.....	35	40402.....	185	41083.....	262
3992.....	191	40210.....	276	40403.....	186	4109.....	104, 324
3993.....	191	40220.....	276	40405.....	186, 241	41093.....	294, 297
40000.....	241, 244	40224.....	277	40412.....	187	4112.....	324
40001.....	244	40225.....	276	40413.....	251	41169.....	248
40002.....	244	40227.....	276	40415.....	250	412.....	48
40003.....	244	40230.....	276	40422.....	270, 296	41225.....	262, 263, 276
40004.....	244	40232.....	276	40423.....	241, 270, 296	41270.....	253
40005.....	244	40233.....	276	40424.....	295	41323.....	271, 296
40006.....	244	40236.....	241, 294	40425.....	295	41349.....	264
40007.....	244	40237.....	294	40430.....	271, 296	41350.....	264
40008.....	244	40261.....	278	40460.....	250	41352.....	264
40010.....	244	40262.....	278	40461.....	250	41354.....	264
40020.....	241, 256	40267.....	278	40462.....	250	414.....	48
40021.....	256	40271.....	278	40465.....	250	41506.....	250
40022.....	256	40275.....	278	40466.....	250	41520.....	254, 259
40023.....	256	4029.....	35	40467.....	250	41567.....	273, 297
40024.....	252	40290.....	241, 254, 259	40468.....	250	41568.....	273, 297
40025.....	241, 249	40291.....	254, 259	40480.....	259	41664.....	289
40026.....	254, 259	40293.....	254, 259	40481.....	259	41672.....	281
40027.....	255	40294.....	254	40485.....	259	41673.....	281
40028.....	247	40300.....	288	40500.....	245	41880.....	265, 296
40040.....	247, 259	40301.....	288	40501.....	241, 245	41881.....	241, 265, 296
40042.....	247, 259	40305.....	288	40521.....	179, 241, 244	4206.....	104, 324
4006.....	104	40306.....	288	40529.....	252	4230.....	193
40070.....	258, 259	4033.....	38	40532.....	252	4231.....	193
40071.....	258, 259	4034.....	38	40541.....	241, 245	4250.....	193, 324
40073.....	259	40340.....	289	40542.....	245	4251.....	193
40074.....	258, 259	40345.....	287	40545.....	245	4260.....	193, 324
40075.....	275, 297	40347.....	196	40546.....	245	4261.....	193
40076.....	275, 297	40349.....	196	40561.....	266, 296	4270.....	193, 324
40077.....	275, 297	4035.....	38	40562.....	266, 296	4271.....	193
40078.....	274	40350.....	196	40564.....	266, 296	43000.....	13
4008.....	35	40351.....	196	40565.....	266, 296	43002.....	13
40081.....	272, 297	40352.....	196	40621.....	267, 296	43004.....	13
40082.....	241, 272, 297	40353.....	196	40634.....	264	43006.....	13
40083.....	272, 297	40354.....	196	40650.....	262	43008.....	13
4009.....	104, 324	40355.....	196	40663.....	269	43010.....	13
4010.....	35	40356.....	196	40670.....	255	43012.....	13
40107.....	272	40359.....	196	40671.....	241, 255	43016.....	13
40108.....	272	40361.....	196, 333	40672.....	255	43018.....	13
40109.....	272	40362.....	196, 333	40673.....	249	43024.....	13, 72
40110.....	248	40370.....	184	40674.....	253	43030.....	13
40111.....	241, 248	40371.....	184	40675.....	253	43032.....	13
40112.....	248	40372.....	184	40676.....	253	43034.....	13
40113.....	248	40373.....	184	40681.....	198	43036.....	13
40114.....	248	40374.....	184, 241	40682.....	198	43038.....	13
40115.....	248	40375.....	184	40683.....	198	43040.....	13
40116.....	248	40376.....	184	40710.....	255	43042.....	13
4012.....	35	40377.....	184	40711.....	255	43050.....	13
40140.....	241, 295	40378.....	185	40712.....	255	43052.....	324
40144.....	241, 294	40379.....	185	40713.....	255	4306.....	133, 183

Prod No	Page No	Prod No	Page No	Prod No	Page No	Prod No	Page No
43066	41	43630	37, 325	43965	41	44518	71
43068	41	43631	37	43980	143	44520	71
43080	13	43633	39	43981	143	44522	71
43082	13	43635	39	43982	143	44524	71
43086	13	43635L	45	43983	143	44532	58
43121	51	43636	39	43984	144	4460	105, 325
43122	51	43636L	45	43986	144	4470	105, 325
43123	51	43637	39	43988	143	4471	105, 325
43126	51	43638	39	43989	143	4512	25, 41, 325
43141	188, 325	4364	183	439945200	36	45222	267, 296
43142	188, 325	43640	39	44010	237	4523FG	139
43143	188, 325	43647	34	44010SKD	237	45267	278
43144	188, 325	43648	34	44011	237	4530	21
43145	188, 325	43649	34	44011SKD	237	4531	21
4315	188	43651	34	44012	237	4532	21
4322	190	43653	34	44030	54, 325	4533	21
4324	190	43655	34	44031	54, 325	4534	21
4326	190	43662	39	4410	105, 325	4535	21
4328	190	43663	39	4411	105, 325	45411	259
4329	190	43664	39	44131	197	45463	247
4330	190	43665	39	44132	197	4549	52
43304	14	43666	39	44133	197	45493	247
43306	14	43668	39	44134	197	4550	52, 325
43308	14	43674	39	44135	197	4551	52, 325
4332	183, 324	4370	190	44136	197	4552	52
43404	14	4370-5	190	44141	197	45571	255
43410	14	4371	190	44142	197	4560	52
43420	14	43737	74	44143	197	4563	52
43422	14	43738	74	44144	197	45643	264
43500	17	43739	74	44145	197	4571	53, 325
43501	17	43743	193	44146	197	4572	53
43503	17	43744	193	4415	198	4573	53
43504	17	43745	74	4416	198	45733	258
43505	17	43772	74	4420	105, 325	4575	53
43512	17	4380	190	4421	105, 325	45772	254
43514	17	43800	15	4425	198	45779	255
43516	17	43801	15	4426	198	45781	253
43520	17	43803	15	4430	105, 325	45850	278
43521	17	4380-5	190	4431	105, 325	4606	104
43522	17	43806	15	44400	72	4609	104
43525	17	4381	190	44400C	73	46300	293
43528	17	43813	15	44402	72	46301	293
43529	17	43814	15	44402C	73	46302	293
43531	17	4381-5	190	44404	72	46303	293
43532	17	43822	15	44406	72	46304	293
43533	17	43840	74	44410	72	46305	293
43540	17	43842	74	44410C	73	4650	53
4355	105	4385	9	44412	72	4651	53
43560	17	43852	9	44414	72	4709	104
43563	17	43854	9	44414C	73	4712	104
4358	190	43856	9	44416	72	4806	104
4360	190	43858	9	44416C	73	4900	198, 325
4360-5	190	43860	9	44418	72	49110-1	187
4361	190	43862	9	44418C	73	49112-1	187
4362	190	43864	9	44420	73	49116-1	187
43620	37	43866	9	44422	73	49122-1	187
43621	37	43868	9	44422C	73	4921	191
43622	37, 324	43872	9	44430	73	4922	191
43623	37	4390	190	44432	73	4923	191
43624	37	4390-5	190	44432C	73	4924	191
43625	37, 324	4391	190	44460	73	4925	191
43626	37, 325	43937	32	44462	73	4926	191
43627	37	43942	49	44462C	73	4928	191
43628	37	43943	49	4450	105, 325	4929	191
43629	37	43944	49	44514	71	4930	191

PRODUCT INDEX

Prod No	Page No	Prod No	Page No	Prod No	Page No	Prod No	Page No
4931.....	191	5232841C2.....	33	5603.....	31, 325	601825.....	175, 333
49500.....	30	5232C203.....	33	5609.....	31	601826.....	175
49501.....	30	5232IB243.....	33	5610.....	31	601828.....	175
49502.....	30	5232RB203.....	33	5612.....	31	601829.....	173
49503.....	30	52412L.....	45	5614.....	31, 325	601830.....	173
49504.....	30	53781717NM010.....	63	5616.....	31, 325	601834.....	173
49505.....	30	53781717NM014.....	63	5640.....	31, 325	601837.....	173
49506.....	30	53781717NM046.....	63	5641.....	31	601840.....	173
4961.....	191	53782020NM010.....	63	5642.....	31	601922.....	172
4962.....	191	53782020NM014.....	63	5643.....	31	601923.....	172
4963.....	191	53782020NM046.....	63	5644.....	31	6020.....	199
500B.....	23	53785252SM010.....	63	5645.....	31	602164.....	173
500M.....	23	53785252SM014.....	63	5646.....	31	602164C.....	173
5024CE29AF010.....	64	53785252SM046.....	63	57285252SM012.....	64	602164P.....	173
5024CE29AF014.....	64	537852AITM010.....	63	575B.....	23	602202.....	218
5024EG29AF010.....	64	53785454SM010.....	63	575M.....	23	602203.....	218
5024EG29AF014.....	64	537854AUTM010.....	63	5806.....	34	602400.....	51
5024FW29AF010.....	64	53785858SM010.....	63	5808.....	34	602424.....	174
5024FW29AF014.....	64	53787272SM010.....	63	5810.....	34, 325	602500.....	51
509.....	105, 325	537876RM010.....	63	5810L.....	45	60275.....	192
5105-2.....	38	537890RM010.....	63	5812.....	34	60277.....	192
5108-2.....	38	53931717NM147.....	63	5812L.....	45	60278.....	192
5109-2.....	330, 332	53932020NM147.....	63	5814.....	34	60279.....	192
5109L.....	45	53935252SM147.....	63	5816.....	34, 325	60280.....	192
5112-2.....	38, 325	5501.....	32	5818.....	34	6030.....	193
5116-2.....	38, 325	5501-2.....	32	5820.....	34, 325	60300.....	199
5120.....	38, 325	5505.....	36	5822.....	34, 325	60300-10.....	189
51515252SM001.....	64	5506.....	32, 325	5822L.....	45	60300-12.....	189
5212.....	32, 325	5506-2.....	32	5832.....	34, 325	60300-16.....	189
5212-2.....	32	5506L.....	45	5865.....	143	60300-20.....	189
5212L.....	45	5508.....	36	59035252SM382.....	64	60300-24.....	189
5216.....	32, 325	5509.....	36	59085252SM625.....	64	60300-30.....	189
5216-2.....	32	5512.....	36	5933.....	15, 74	60300-40.....	189
52163550D.....	33	5517.....	36	5CC118MP-12.....	65	60300-6.....	189
52163550E.....	33	5519.....	36	5CC120MP-12.....	65	60300-8.....	189
52163841A.....	33	5526.....	32	5CC200PC-12.....	65	60306.....	172
52163841F.....	33	5526-2.....	32	5CC55PC-12.....	65	6031.....	193
5216841C2.....	33	5529.....	32	5CCCCLIP-12.....	65	60322.....	174
5216C203.....	33	5529-2.....	32	5CCLCLIP-12.....	65	60324.....	174
5216IB203.....	33	5532.....	32, 325	600295.....	88	60344.....	172
5216RB203.....	33	5536.....	42	600296.....	88	60345.....	172
5220.....	32, 325	5538.....	42	601000.....	170	60346.....	172
5220-2.....	32	5540.....	42	601001.....	170	6041.....	174
52203550.....	33	5544.....	42	601002.....	170	604144.....	173
52203550A.....	33	55520.....	68	601003.....	170	604174.....	173
52203841B.....	33	55522.....	68	60100PC.....	169	6042.....	174
52203841G.....	33	55524.....	68	60101.....	169	6043.....	174
5220841C2.....	33	55526.....	68	60102.....	169	604300.....	188
5220C203.....	33	55528.....	68	601028.....	170	604310.....	188
5220IB203.....	33	55530.....	68	601029.....	170	604358.....	189
5220RB203.....	33	55532.....	68	60103.....	170	604359.....	189
5224.....	32, 325	55534.....	68	601031.....	170	604360.....	189
52243550G.....	33	55536.....	68	601306.....	175	604361.....	189
52243550H.....	33	55538.....	68	601405.....	192	604370.....	189
52243841C.....	33	55540.....	68	601408.....	192	604371.....	189
52243841H.....	33	55542.....	68	601413.....	192	604380.....	189
5224841C2.....	33	55544.....	68	601416.....	192	604381.....	189
5224C203.....	33	55546.....	68	601420.....	192	604390.....	189
5224IB203.....	33	55550.....	68	601526.....	194	604392.....	189
5224RB203.....	33	5570.....	43	601527.....	194	6044.....	174
5232.....	32, 325	5573.....	43	601528.....	194	604460.....	88
52323841D.....	33	5583.....	43	601529.....	194	604606.....	88
52323841I.....	33	5587.....	43	601642.....	175	604609.....	88
5232-63550J.....	33	5601.....	31, 325	601647.....	175	606040.....	183
5232-63550I.....	33	5602.....	31, 325	601824.....	175	606055.....	183

Prod No	Page No	Prod No	Page No	Prod No	Page No	Prod No	Page No
606086	183	607556	194	608212	130	60914C	171
606106	133	607560	194	608236	217	60914RS	167
606902	173	607562	194	60830	192	60914SERS	166
606903	173	607566	194	608530	130	60914XRS	166
607000C	217	607650	88	608600	130	609170	93
607000CS	217	607651	88	608901	148	609171	86
607000H	217	607652	88	608902	148	609172	86
607001	217	607653	88	608904	148	609173	86
607002	217, 333	607654	88	608905	148	609179	59
607002D	218	607655	88	608907	148	609183	59
607002P	217	607656	88	608908	148	609190	133
607004	217	607657	88	608909	148	609191	133
607004P	217	607658	88	608913	148	609193	133
607006	217	607680	89	608917	149	609196	86
607006P	217	607682	89	608918	148	609201	85
60700HL2	217	607683	89	608919	148	609202	85
60700HL4	217	607685	89	608924	23	609203	85
60700HL6	217	607687	89	609001	88	609204	85
60700HLC	217	607690	89	609002	88	609208	85
60708RS	167	607691	89	609003	88	609209	85
6070A	218	607692	89	609005	88	60921	170
60710RS	167	607693	89	609006	88	609211	85
607120C	217	607695	89	609007	88	609215	85
607120CS	217	607697	89	609009	88	609216	85
607122	217	607704	219	60907C	171	609270	43
607122P	217	607704CS	219	60907RS	167	609273	43
607124	217	607707	219	60907SERS	166	609310	91
607124P	217	607707CS	219	60907XRS	166	609316	91
607126	217	607707H	219	609082	86	60934	170
60712RS	167	607711	219	609083	86	60RS-1	333
607130C	217	607711CS	219	609084	86	60RS-2	333
607130CS	217	607711H	219	609085	86	60RS-3	333
607132	217	607802H	217	609086	86	61115	168
607134	217	607813	198	60908C	171	61120	168
607136	217	607813P	198	60908RS	167	61120C	171
607140C	217	607813S	198	60908SERS	166	61125	168
607140CS	217	607815	198	60908XRS	166	61125C	171
607142	217	607815P	198	609092	86	61130	168
607144	217	607815S	198	609093	86	61130C	171
607146	217	607901	218	609094	86	61200	168
607160C	217	607902	218	609096	86	61200C	171
607160CS	217	607902C	218	609097	86	61210	168
607162	217	607904	218	609106	132	61210C	171
607164	217	607904C	218	609107	131	61212	168
607166	217	607908	218	609109	131	61216	168
607190C	217	607908C	218	60910C	171	61216C	171
607190CS	217	607912	218	60910RS	167	61220	168
607192	217	607912C	218	60910SERS	166	61220C	171
607194	217	608002	217	60910XRS	166	61224	168
6071A	218	608004	217	609110	131	61224C	171
607230C	217	608006	217	609111	53	61232	168
607232	217	608122	217	609112	53	61232C	171
607236	217	608124	217	609113	53	61240	168
607351	195	608126	217	60912C	171	61240C	171
607352	195	608132	217	60912RS	167	61260	168
607353	195	608134	217	60912SERS	166	61260C	171
607354	195	608136	217	60912XRS	166	61280	168
607356	195	608142	217	609131	58	61280C	171
607358	195	608144	217	609132	58	61302	169
607362	195	608146	217	609133	58	61302C	171
607376	195	608162	217	609143	130	61305	169
607410	199	608164	217	609144	130	61305C	171
607531	193	608166	217	609145	130	61308	169
607550	194	608192	217	609146	131	61308C	171
607552	194	608194	217	609147	131	614	143

PRODUCT INDEX

Prod No	Page No	Prod No	Page No	Prod No	Page No	Prod No	Page No
614PC.....	143	6695.....	329	7420.....	24	8910.....	77
614R.....	143	6696.....	329	7543.....	332	8919.....	77
615.....	143	6697.....	329	7545.....	332	8920.....	77
61702.....	169	6705.....	329	7546.....	332	9001.....	330
61702C.....	171	6706.....	329	7547.....	332	9002.....	330
61704.....	169	6707.....	329	7548.....	332	9003.....	330
61704C.....	171	6708.....	329	7549.....	332	9004.....	330
61707.....	169	6709.....	329	7550.....	121	9005.....	330
61707C.....	171	6713.....	79	7551.....	332	9051.....	110
61708.....	169	6716.....	79	7552.....	332	9052.....	110
61708C.....	171	6723.....	79	7555.....	121	91020.....	26
61710.....	169	6726.....	79	7670.....	110	91040.....	26
61710C.....	171	6843.....	87	7671.....	110	91055.....	26
61905.....	169	6863.....	87	7702.....	330	91065.....	26
61905C.....	171	6904.....	22	7704.....	330	91070.....	26
61907.....	169	6907.....	22	7711.....	107	91075.....	26
61907C.....	171	6908.....	82	7721.....	107	91080.....	26
6302FMT.....	140	6909.....	82	7725.....	107	91085.....	26
630FMT.....	140	6914.....	82	7749.....	329	91090.....	26
63910L.....	45	6917.....	82	7750.....	329	91095.....	26
63912L.....	45	6919.....	82	7752.....	329	9148.....	110
6400.....	187	6931.....	82	7753.....	329	9160.....	110
6401.....	187	6942.....	82	7754.....	329	9172.....	110
6413.....	149	6947.....	82	7755.....	329	9224.....	110
6416.....	149	6954.....	22	7756.....	329	9248.....	110
6417.....	149	6956.....	22	7760.....	329	9260.....	110
6426.....	149	6963.....	78	7761.....	329	9272.....	110
6439.....	149	6966.....	78	7900.....	77	9325.....	330
6450.....	149	6982.....	80	7901.....	77	9345.....	330
6504.....	55	6982L.....	80	7910.....	76	9365.....	330
650B.....	23	6984.....	80	7913.....	76	9375.....	330
650M.....	23	69844.....	80	7914.....	76	9547.....	330
6524.....	55	69846.....	80	7916.....	76	9561.....	330
6526.....	55	6984L.....	80	7918.....	76	9573.....	330
6527.....	55	6986.....	80	7919.....	76	9645.....	330
6531.....	78	69864.....	80	7920.....	76	9648.....	330
6532.....	78	69866.....	80	7924.....	71	9660.....	330
6534.....	78	6986L.....	80	7926.....	71	9672.....	330
6550.....	54	6988.....	80	7928.....	71	9675.....	330
6551.....	54	6990.....	80	7930.....	75	9710.....	110
6552.....	54	7000.....	40	7932.....	75	9712.....	110
6553.....	54	7006.....	25	7934.....	75	9720.....	110
6555.....	54	7008.....	25	7940.....	14	9722.....	110
6600.....	109	7038.....	103, 330	7942.....	14	9848.....	330
6601.....	109	7039.....	103	7944.....	71	9850.....	330
6602.....	329	70900.....	40	7946.....	71	9851.....	330
6603.....	329	70901.....	40	7948.....	71	9948.....	330
6605.....	109	70902.....	40	8004.....	41, 325	ADD4.....	304
6606.....	109	70903.....	40	800B.....	23	ADD6.....	304
6608.....	109	70904.....	40	800M.....	23	ADDA.....	333
6611.....	109	70905.....	40	8038.....	83	ADDC.....	304, 333
6616.....	329	7110.....	59	8099.....	83	ADDD.....	304, 333
6620.....	109	7111-4.....	59	8100.....	83	ADDR.....	304
6621.....	109	7112.....	59, 328	8104.....	41	ADS4.....	304
6625.....	109	7206.....	84	8110.....	81	ADS8.....	304
6672.....	329	7208.....	84	8112.....	81	ADSC.....	304, 333
6673.....	329	7210.....	84	8302FMT.....	140	ADSD.....	304, 333
6676.....	329	7212.....	84	830FMT.....	140	ARR112.....	74
6678.....	329	7215.....	84	8505.....	41, 325	ARR120.....	74
6682.....	329	7218.....	84	8508.....	81	ARR240.....	74
6684.....	329	7223.....	84	8819.....	81	BC05.....	126
6686.....	329	7325.....	83	8821.....	81	BIN27.....	219
6687.....	329	7400.....	24	8886.....	79	BIN27L.....	219, 333
6688.....	329	7405.....	24	8887.....	79	BIN36.....	219
6693.....	329	7410.....	24	8888.....	79	BIN36L.....	219, 333

Prod No	Page No	Prod No	Page No	Prod No	Page No	Prod No	Page No
BIN44	219	CM1126	98	IC2220	163	LD350N	160
BIN44L	219, 333	CM1127	98	IC222LH	332	LD500N	159
C111	232	CM1128	98	IC222WH	332, 333	LD500NSS	160
C135	232	CP2036	301	IC225CSB	332	LD501BD	332
C2220A	233	CT1014	141	IC2250	163	LRP20	333
C2222A	233	CT1014	323	IC2250HA	332	MYCK	155
C2222C	233, 332, 333	CT1216	141	IC2250T	163	N44010	236
C2222HD	233, 333	CT1216	323	IC2254	163	N44011	236
C2236	233	CT1217	141	IC2254CS	332, 333	N44012	236
C2236H	233	CT1217	323	IC225CR	329, 332, 333	OP304	129
C2237	233, 333	CT1418	141	IC225CSB	329, 332, 333	OP305	129
C32P1	232	CT1418	323	IC225FD	332	OP311	129
C32P2	232	CT1713TR	141, 323	IC225LH	332	OP314	129
C35P	232	CW6C	232	IC225WH	332	OP316	129
C3620W	149	DL1826	162	IG1011	132	OP371	129
C3625	149	DL300	162	IG224	132	OP373	129
C3625T	149	DL300R	162	IG245	132	OSB172	84
C3630W	149	EP214	128	IT1000	154	OSB176	84
C93	232	EP215	128	IT140	155	OSB178	84
CC11SH	301	EP216	128	IT160	155	P614	143
CC11TH	301	EP217	128	IT180	155	P614R	143
CC2036	301	EP320	128	IT250	154	PC140N	161
CC2036DP	301	GR09	128	IT400	155	PC146GA	332
CC2036P	301	GR09RS	332	IT410	155	PC146LG	332
CC2243	301	GR10	128	IT500	154	PC160N	161
CCSTR2036	333	Group A	27	JC1945CB	307	PC180N	161
CD2036	301	Group AT	27	JC1945L	307	PC181GA	332
CH03	125	Group B	27	JC1945S	307	PC181LG	332
CH15	125	Group BT	27	JC1946	307	PC300N	161
CHI4	332	Group C	27	KL102	19	PC301GA	332
CHI6	332	Group CT	27	KL108	19	PC301HA	332
CM1012	21, 100	Group D	27	KL115	19	PC301LG	332
CM1013	21, 100	Group DT	27	KL116	19	PC600N	161
CM1017	101	Group E	27	KL118	19	PC660	160
CM1030	100	Group ET	27	KL119	19	PCD205	20
CM1032	100	Group P1	27	KL121	19	PCD206	20
CM1033	100	Group P1T	27	KL123	19	PCD207	20
CM1033P	100	Group P2	27	KL126	19	PCD209	20
CM1035	100, 331	Group P2T	27	KL127	19	PCD210	20
CM1037	100, 331	Group P3	27	KL200	19	PCD211	20
CM1040	99	Group P3T	27	KL201	19	PCD220	20
CM1042	99	Group P4	27	KL203	19	PCD305	20
CM1042LP	99	Group P4T	27	KL204	19	PCD308	20
CM1043	99	HL7237	181	KL205	19	PCD310	20
CM1045	99	HL7237PS	181	KL350	19	PCD312	20
CM1046	99	HL8185	181	KL444	144	PCD313	20
CM1049	99	HL8185B	181	KL800	19	PCD316	20
CM1050	101	HL8185C	181	KL805	19	PCD319	20
CM1058	101	HL8185G	181	KL920	19	PCD412	20
CM1065	101	HL8185GB	181	KL924	19	PCD796	20, 325
CM1069	101	HL8185GC	181	KL928	19	PCD801	144
CM1072	192	HL8195	181	LB10	83	PS101CS	126
CM1100	98	HL8195B	181	LB12	83	PS103	123, 332
CM1100C14	96	HL8285	181	LB16	83	PS103AT	123, 332
CM1101	98	HL8285B	181	LD1000N	159	PS203	123, 332
CM1101C14	96	HL8285G	181	LD1001GA	332	PS204	122
CM1102	98	HL8285GB	181	LD1001LG	332	PS204AST	122
CM1102C14	96	HLA20	181, 333	LD111VC	332	PS304	123, 332
CM1103	98	HLA8	333	LD112VC	332	PS304AT	123, 332
CM1103C14	96	HLRP11	333	LD222LA	332	PS501N	123
CM1104	98	HLRP5	333	LD222NLA	332	PS502N	123
CM1104C14	96	HLRP6	333	LD235GA	332	PS6012	123
CM1105	98	HLRP7	333	LD235LG	332	PS601N	123
CM1105C14	96	HLRP999	333	LD250N	159	PS601NC	122
CM1125	98	HT3220	303	LD333FA	332	PS602N	123

PRODUCT INDEX

Prod No	Page No	Prod No	Page No	Prod No	Page No	Prod No	Page No
PS603N.....	123, 332	RG25-5C.....	228	SB70.....	84	ST1544.....	213
PS701B.....	123	RG36.....	229	SB72.....	84	ST1556.....	213
PS702.....	123	RG36-1.....	229	SB74.....	84	ST1568.....	213
PS801B.....	123	RG36-1C.....	229	SB76.....	84	ST1573.....	213
PS802.....	123	RG36-2.....	229	SB78.....	84	ST1587.....	213
PSD13CH.....	87	RG36-2C.....	229	SB79.....	84	ST1629.....	213
PSD13EH.....	87	RG36-3.....	229	SB90.....	83	ST1630.....	213
PSD21CH.....	87	RG36-3C.....	229	SB94.....	83	TC1826GA.....	332
PSD21DEH.....	87	RG36-4.....	229	SBA1.....	90	TC1826N.....	161
PSD21EH.....	87	RG36-4C.....	229	SBC11SH.....	302	TP100.....	115
PT4824.....	303	RG36-5.....	229	SBC11TC.....	302	TT005.....	321
RB.....	230	RG36-5C.....	229	SBC1521.....	301	TT010.....	321
RC16.....	231	RG49.....	229	SBC2031.....	301	TT105.....	321
RC16-1.....	231	RG49-1.....	229	SBC230.....	302	TT110.....	321
RC20.....	231	RG49-1C.....	229	SBCC240.....	301, 333	TT175.....	321
RC20-1.....	231	RG49-2.....	229	SBCC245.....	301, 333	UC1940.....	303
RDC.....	233	RG49-2C.....	229	SBG1.....	90	UC3031524.....	302
RDC1.....	233	RG49-3.....	229	SC25.....	144	UC3031827.....	302
RE.....	226, 227, 228, 229, 230	RG49-3C.....	229	SC26.....	144	UC4018.....	303
RE16.....	227	RG49-4.....	229	SC27.....	144	UC4031529.....	302
RE16C.....	227	RG49-4C.....	229	SC29.....	144	UC4031733.....	302
RE25.....	228	RG49-5C.....	229	SC32.....	87	UC4525.....	303
RE25C.....	228	RG9.....	226	SC40.....	144	UC5031524.....	302
RE36.....	229	RG9-1.....	226	SCL1.....	90	UC5031827.....	302
RE36C.....	229	RG9-1C.....	226	SD01.....	90	UC5032135.....	302
RE49.....	229	RG9-2.....	226	SEA1.....	90	UC7022133.....	302
RE49C.....	229	RG9-2C.....	226	SFI1.....	90	UC7031524.....	302
RE9.....	226	RG9-3.....	226	SGR1.....	90	UC7031827.....	302
RE9C.....	226	RG9-3C.....	226	SHR1.....	90	UC7032133.....	302
REW20S.....	223	RG9-4.....	226	SL6011L.....	90	UD1726.....	162
REW20SC.....	223	RG9-4C.....	226	SL6011TC.....	90	WB965.....	55
REW30S.....	223	RG9-5.....	226	SMMC10.....	92	WPM20.....	129
REW30SC.....	223	RG9-5C.....	226	SMMC12.....	92	WPM25.....	129
RF.....	230	RHC.....	233	SMMC8.....	92	WPM45.....	129
RFP.....	231	ROP.....	230	SMO1624.....	92	WPM85.....	129
RG16.....	227	RP.....	230	SMO2232.....	92	XB3.....	156
RG16-1.....	227	RPC.....	231	SMOC24.....	92	XB35GA.....	332
RG16-1C.....	227	RSP.....	231	SMR12.....	92	XB35LG.....	332
RG16-2.....	227	RTP.....	230	SMR16.....	92	XB5.....	156
RG16-2C.....	227	RW20.....	223	SMR1624.....	92	XDL3000H.....	162
RG16-3.....	227	RW20-1C.....	223	SMR1836.....	92	XT10000.....	158
RG16-3C.....	227	RW20-2C.....	223	SMR24.....	92	XT10001GA.....	332
RG16-4.....	227	RW20-3C.....	223	SMTD16.....	92	XT10001LG.....	332
RG16-4C.....	227	RW20-4C.....	223	SMTD24.....	92	XT1400.....	157
RG16-5.....	227	RW20-C.....	223	SP18.....	91	XT1468L.....	332
RG16-5C.....	227	RW30.....	223	SP22.....	91	XT1600.....	157
RG25.....	228	RW30-1C.....	223	SPD123.....	111	XT1800.....	157
RG25-1.....	228	RW30-2C.....	223	SPD300.....	111	XT2500.....	158
RG25-1C.....	228	RW30-3C.....	223	SPD300KD.....	111	XT2550.....	332
RG25-2.....	228	RW30-4C.....	223	SPD303.....	111	XT2550GA.....	332
RG25-2C.....	228	RW30-C.....	223	SPD303KD.....	111	XT2550LA.....	332
RG25-3.....	228	S310.....	48	SS105.....	125	XT3000R.....	157
RG25-3C.....	228	S312.....	48	SS107.....	332	XT5000.....	158
RG25-4.....	228	S314.....	48	SSD100.....	115		
RG25-4C.....	228	SB66.....	84	SSW1.....	90		
RG25-5.....	228	SB68.....	84	ST1532.....	213		

TERMS & CONDITIONS — Carlisle FoodService Products



1. Terms and Method of Payment

- a. All orders are subject to approval and acceptance by SELLER. No order accepted by SELLER shall be subject to cancellation, termination, suspension, change, reduction, cutback or other modification except with SELLER'S prior written consent.
- b. Our standard terms of payment are net 30 days from invoice date. The amount of terms of credit, if extended, may be changed or credit withdrawn by SELLER at any time. No orders will be shipped on a COD basis.
- c. Prices do not include federal, state or local taxes, duties or other levies, now or hereafter enacted, applicable to the items deliverable under the sales order or invoice (hereinafter called ITEMS), which taxes, duties, or other levies will be added by SELLER to the sales price and will be paid by BUYER unless BUYER provides SELLER with a proper exemption certificate.
- d. Packaging for commercial shipment is included in the contract price. Any special packaging, crating or shipping instructions must be noted on BUYER'S original order and acknowledged by SELLER.

2. Title and Delivery

The ITEMS shall be delivered F. O. B. SELLER'S plant, and title thereto shall pass to BUYER, upon SELLER'S delivery of the ITEMS to a common carrier for shipment to BUYER. All items from the Carlisle FoodService Products catalog may be combined to obtain prepaid freight, regardless of the shipping point. Freight is prepaid on all orders totaling \$2,500 net or more to one destination within the contiguous 48 United States. Freight on prepaid International Shipments will be paid on normal ground transportation from shipping point to the consignee. When the order qualifies for prepaid freight, Seller shall have the right to select the means of transportation. If Buyer requires a means of transportation other than the one normally selected by Seller, any extra cost incurred by reason of using such other means shall be paid by Buyer. Palletized international orders requiring heat treated pallets will be charged \$4.25 net per pallet. International orders requiring heat treated certified bark-free pallets will be charged \$18.50 net per pallet. Any accessorial charges incurred because of a customer request will be the responsibility of the requester. Any items backordered from a prepaid shipment will be forwarded prepaid. Items backordered from ex works shipments will be forwarded ex works.

3. Inspection and Acceptance

Thoroughly inspect all shipments. Do not accept a damaged or short shipment until exception is noted on the freight bill. BUYER will be held responsible for all shipments with freight bills signed free and clear. If concealed damage is discovered, contact the freight company immediately for inspection. Concealed damage must be reported to the carrier within 7 days of receipt. All damaged goods and shortages that are not properly documented and reported upon receipt become the sole responsibility of the BUYER.

4. Patent Indemnification

SELLER shall protect and indemnify BUYER and its directors, officers, agents and employees against all claims for damages or profits, including all reasonable costs incurred by BUYER in connection therewith, arising from infringement of patents, copyrights, trademarks or misappropriation of designs.

5. Returns and Cancellations

No returns will be accepted without an authorization number from Carlisle Customer Service. An authorization number may be obtained by calling 800 654 8210 and requesting a Return Authorization from Customer Service. All requests for return must occur within 90 days of the original shipment of the product unless special authorization is obtained. Merchandise returned without authorization will be refused and returned to the customer, freight collect.

Any merchandise must be returned freight prepaid, and is subject to a minimum of 15% restocking charge.

All returned goods must reference the original invoice and purchase order. Returned goods must be in original standard packs and in unused salable condition. Special Order Products and discontinued items will not be accepted for exchange or return. This includes any articles custom imprinted or modified for purchaser.

6. General

- a. All prices are list and subject to change without notice. Orders from authorized accounts will be accepted with the understanding that prices are those in effect at the time of shipment. These prices are exclusive of all sales taxes which may be levied by State, Federal, or City governments.
- b. Orders less than \$100.00 net will be charged a \$10.00 handling fee. The initial order requirement for a new customer is \$3,500 net, and must be accompanied by a tax exemption certificate.
- c. Orders calling for less than a standard case pack will be charged \$5.00 net each per broken case.
- d. Orders requiring 3rd party freight billing will be accessed a \$5.00 per order processing charge.
- e. All orders of custom products are subject to shipment of plus or minus 10% of the quantity ordered.
- f. No ITEMS to be furnished hereunder shall be exported by BUYER unless SELLER is first notified in writing of the intention to so export and all applicable regulations and licenses are complied with and obtained by BUYER or its customer.
- g. SELLER hereby certifies that the goods described herein of its manufacture will be produced in compliance with all applicable requirements of Sections 6, 7 and 12 of the Fair Labor Standards Act, as amended, and all order of the United States Department of Labor issued under Section 14 thereof. SELLER further certifies that it is in compliance with the Equal Employment Opportunity clause in Section 202, paragraphs 1 through 7 of Executive Order 11246, as amended, relative to equal employment opportunity and the implementing Rules and Regulations of the Office of Federal Contract Compliance.
- h. SELLER is not responsible for typographical errors made in any of its publications or for stenographic or clerical errors made in preparation of quotations, sales orders, acknowledgments, or invoices. All such errors are subject to correction.
- i. This agreement shall be governed by the laws of the state of Oklahoma.
- j. SELLER'S "Terms and Conditions" as set forth above shall govern all transactions. Any inconsistent terms of BUYER wherever set forth and whether oral or written, shall not be binding upon SELLER unless agreed to by SELLER in writing. No waiver or exception to any of the hereinabove enumerated conditions or any of the special terms and provisions relating to any order shall be binding upon SELLER unless agreed to in writing by SELLER.
- k. SELLER reserves the right to change or discontinue the color, design, component content or price of any ITEMS in SELLER'S catalog or published price lists without prior notice at any time.

The specifications and prices listed in this document are subject to change. Carlisle does not assume responsibility for typographical errors.



4711 E Hefner Rd
Oklahoma City, OK 73131
Toll Free: 800.654.8210 • Toll Free Fax: 800.872.4701
Phone: 405.475.5600 • www.carlislefsp.com
Printed in USA • CAT2015FSP
©2015 Carlisle FoodService Products

